

21



atena *lux*[®]

Lighting
COLLECTION



LIGHTING EMOTIONS



25th anniversary passion for Light

Fondata nel 1994, ATENA LUX è una realtà dinamica e giovane riconosciuta sul territorio nazionale ed estero come produttore di sistemi di illuminazione per i settori tecnico e medicale. La ricca gamma di corpi illuminanti, che vengono progettati e realizzati all'interno del comparto produttivo situato a Gruaro (VE), sono sinonimo di **garanzia, comfort e sicurezza**. Dotata di un parco utensili di ultima generazione e di laboratorio fotometrico interno, l'azienda offre soluzioni personalizzate e supporto nella progettazione illuminotecnica. **Flessibilità, creatività e know-how tecnico** contraddistinguono le soluzioni illuminotecniche di ATENA LUX che rispondono in modo efficiente ai requisiti specifici delle normative vigenti garantendo i migliori risultati in termini di performance e di risparmio energetico.

*Founded in 1994, ATENA LUX is a dynamic and young company, recognised as manufacturer of lighting solutions for technical and medical sector. The wide range of lighting fittings, entirely designed and produced inside the production area located in Gruaro (VE), are synonymous with **guarantee, comfort and safety**. Equipped with several latest technology machines and an internal photometric laboratory, the company offers customized solutions and support in lighting design. ATENA LUX lighting solutions are characterized by **flexibility, creativity and technical know-how** and respond efficiently to the specific requirements of current regulations in order to guarantee the best results in terms of performance and energy savings.*



“Ci mettiamo alla prova ogni giorno offrendo soluzioni uniche e specifiche che nascono e si concretizzano per assecondare al meglio le richieste dei clienti.”

“We test our abilities every day by offering unique and specific solutions that are designed and realized to satisfy our customers' requests in the best way.”

Arch. Luigina Barbuio
Atena Lux CEO

ATENA LUX

TI GUIDA A ILLUMINARE LA TUA UNICITÀ

Atena Lux guides you to light up your uniqueness

Atena Lux include l'innovazione strategica sostenibile tra le sue strategie principali per creare valore duraturo e condiviso ponendo al centro dei suoi obiettivi anche l'affermazione dei **valori etici e comportamentali**. Attraverso la stesura del **CODICE ETICO**, Atena Lux vuole trasmettere il suo impegno costante nel perseguire e promuovere i **principi di onestà, correttezza e buona fede nei rapporti con fornitori e clienti, di massima qualità nella realizzazione del prodotto e di rispetto verso la Comunità sociale e verso l'Ambiente**.

*Atena Lux includes sustainable strategic innovation among its main strategies to create lasting and shared value, placing the affirmation of ethical and behavioral **values at the center of its objectives**. Through the drafting of the **CODE OF CONDUCT**, Atena Lux wants to convey its constant commitment in pursuing and promoting the **principles of honesty, fairness and good faith in relations with suppliers and customers, of the highest quality in the creation of the product and respect for the social community and the environment**.*



CODICE ETICO

CODE OF CONDUCT

VALORI VALUES

COMPETENZA COMPETENCE

Oltre ad avvalersi di personale qualificato, **Atena Lux** è fermamente convinta che il **miglioramento continuo** e la **crescita professionale** sia alla base della creazione di valore duraturo e condiviso. L'azienda promuove l'aggiornamento e la formazione dei lavoratori perché siano essi stessi portatori di **innovazione ed eccellenza**.

*In addition to making use of qualified personnel, **Atena Lux** is firmly convinced that **continuous improvement** and **professional growth** are the basis for the creation of lasting and shared value. The company promotes the development and training of workers so that they themselves are carriers of **innovation and excellence**.*

PRECISIONE PRECISION

La progettazione e realizzazione dei prodotti sono il frutto di un **attento studio delle esigenze del cliente** e si concretizza nella **cura di ogni singolo dettaglio**. Il risultato finale deriva dall'intersezione minuziosa di ogni diversa azione portata avanti con premura e accuratezza dalla fase di progettazione alla produzione.

*The design and manufacture of the products are **realized considering every single detail**, final products are the result of a **careful study of the customer's needs**. The meticulous intersection of each different action carried out with care and accuracy from the design phase to production gives life to the final product.*

EQUILIBRIO EQUILIBRIUM

Un ambiente di lavoro sereno e bilanciato è importante perché ogni **risorsa** possa esprimersi al meglio. Il modello organizzativo dell'azienda è volto a mantenere un **corretto equilibrio nella gestione del tempo** e delle responsabilità non solo lavorative ma anche famigliari.

*Every human being can express himself at his best if there is a serene and balanced work environment. The company's organizational model is aimed at maintaining a **correct balance between work responsibilities and time** dedicated to the family.*

UMANITA' HUMANITY

Un **clima di apertura, ascolto e condivisione** verso tutti coloro che collaborano con l'azienda investendo il loro tempo, lavoro e idee è essenziale per una crescita non solo economica ma anche umana. Condividendo pensieri e proposte con il proprio organico, strategie e decisioni vengono prese nel rispetto di tutte le risorse umane e ambientali.

*Carry out an **atmosphere of openness, listening and sharing** towards all those who collaborate with the company by investing their time, work and ideas is essential for growth that is not only economic but also human. Sharing thoughts and proposals with its staff, strategies and decisions are made with respect for all human and environmental resources.*

SVILUPPO SOSTENIBILE

SECONDO GLI OBIETTIVI DELL'AGENDA 2030

*Guided by the
Sustainable Development Goals of Agenda 2030*

Il processo produttivo di Atena Lux avviene all'interno di una **struttura moderna** realizzata nel 2018 secondo le logiche della **Sostenibilità Ambientale e Sicurezza**.

Grazie all'introduzione di nuove tecnologie ad elevata efficienza energetica, nella fase di produzione è possibile **ridurre gli sprechi di energia e di materiali** dovuti a prodotti non conformi.

La progettazione tiene in considerazione lo smaltimento del prodotto, utilizzando il più possibile **materiali riciclabili**. Alla base dei prodotti **durevoli e di qualità di Atena Lux**, esiste un attento studio e analisi delle materie prime e dei componenti.

Ogni nuovo progetto che nasce in Atena Lux diventa un'azione **responsabile verso il Pianeta per un comune futuro migliore**.

*The production process of Atena Lux takes place inside a **modern structure** built in 2018 according to the logic of **Environmental Sustainability and Safety**.*

*Thanks to the introduction of technologies it is possible to **reduce the waste of energy and materials** due to non-conforming products.*

*The design considers the disposal of the product, using **recycling materials** as much as possible.*

*All Atena Lux **durable and quality products** come from a careful study and analysis of raw materials and components.*

*Each new project born in Atena Lux becomes a **responsible action towards the Planet for a better common future**.*



SALVAGUARDIA AMBIENTALE

ENVIRONMENT PROTECTION

- Produzione in acciaio e alluminio 100% riciclabili
 - Packaging 100% riciclabile
- Utilizzo di sorgenti LED prive di mercurio
- *Production in steel and aluminium 100% recyclable*
 - *100% recyclable packaging*
 - *Use of mercury-free LED sources*



ENERGIA PULITA

GREEN ENERGY

Oltre ad utilizzare l'energia fotovoltaica, l'azienda aderisce al programma di certificazione **100% energia pulita** utilizzando energia proveniente interamente da fonti rinnovabili.

*In addition to using photovoltaic energy, the company also takes part to the **100% clean energy** certification program using energy coming entirely from renewable sources.*

RESPONSABILI

SOCIAL RESPONSABILITY



SICUREZZA NEL LAVORO SAFE WORKING ENVIRONMENT

Ambiente produttivo incentrato sulle esigenze dei lavoratori in termini di sicurezza, ergonomia e soddisfazione garantendo un ambiente sicuro, confortevole e flessibile a tutti gli operatori.

The production environment is focused on workers' needs in terms of safety, ergonomics and satisfaction, guaranteeing a safe, comfortable and flexible environment for all operators.



COMFORT AMBIENTALE ENVIRONMENTAL COMFORT

Illuminazione degli uffici e della produzione incentrata sul principio della Human Centric Lighting in grado di contribuire ad un bioritmo salutare e favorire la concentrazione e la soddisfazione dei collaboratori nelle loro attività quotidiane.

Lighting of offices and production are based on the principle of Human Centric Lighting capable of contributing to a healthy biorhythm and promoting the concentration and satisfaction of the staff in their daily activities.

LITÀ SOCIALE

AFFIDABILITÀ

RELIABILITY

La progettazione dei corpi illuminanti di Atena Lux non può prescindere dal rispetto delle normative di riferimento che definiscono i requisiti illuminotecnici per i luoghi di lavoro per interni (UNI EN 12464-1). Un buon approccio progettuale non solo consente di realizzare un ambiente confortevole e sano per l'utente, ma permette anche una migliore valutazione dei costi di installazione e manutenzione nel tempo.

Atena Lux lighting fittings are designed according to the reference standards that define the lighting engineering requirements for indoor workplaces (UNI EN 12464-1). A good design approach not only allows to create a comfortable and healthy environment for the user, but also allows a better assessment of installation and maintenance costs over time.

LED

CHE FA LA DIFFERENZA

LED THAT MAKES THE DIFFERENCE



Gli apparecchi di Atena Lux integrano LED di ultima generazione, ingegnerizzate secondo le specifiche esigenze progettuali dell'azienda. I prodotti Atena Lux contengono sorgenti luminose ad alta efficienza energetica.

The latest generation LED sources, used inside Atena Lux lighting fittings, are engineered according to the company's specific design needs. Atena Lux products contain high energy efficiency light sources.

DURABILITÀ

ED EFFICIENZA

DURABILITY AND EFFICIENCY



I diodi LED utilizzati sono selezionati al fine di garantire una cromaticità uniforme (3 ellissi MacAdam) e vantano elevate performance illuminotecniche. L'elevata efficienza dei corpi illuminanti consente un notevole risparmio in termini di quantità di apparecchi utilizzati e di manutenzione.

The LEDs used are selected to ensure uniform chromaticity (3 MacAdam ellipses) and assure high lighting performances. The high efficiency of the lighting fittings allows considerable savings in terms of quantity of luminaires used and maintenance.

AFFIDABILITÀ

RELIABILITY

DURATA

>50.000h L90/B10

LIFE hours >50.000 L90/B10



Il funzionamento delle sorgenti LED è garantito per 50.000 ore e l'indice di decadimento del flusso luminoso è decisamente basso: al raggiungimento delle 50.000 ore di funzionamento, il 90% delle sorgenti LED è in grado di garantire un flusso luminoso residuo di almeno il 90% del flusso luminoso iniziale.

The LED sources are guaranteed for 50,000 hours of operation and the luminous flux decay index is very low: after 50000 hours of operation, 90% of the LED sources are able to guarantee a residual luminous flux of at least 90% of the initial luminous flux.

RISCHIO FOTOBIOLOGICO ESENTE

PHOTO-BIOLOGICAL RISK EXEMPT



Progettati in conformità alla norma CEI EN 62471 – Sicurezza fotobiologica delle lampade e sistemi di lampada – i corpi illuminanti di Atena Lux rientrano nel gruppo RG 0 (rischio esente), perciò non rappresentano un rischio per la salute dell'uomo, neanche dopo un'esposizione prolungata.

Planned according to the CEI EN 62471 regulation Photo-biological safety for luminaires and luminaires systems- Atena Lux lighting fittings are part of the RG 0 risk group (exempt risk group); this means that their levels will never be dangerous for the human body, even after a long time exposure.

RIFERIMENTI NORMATIVI

REGULATORY REFERENCES



Tutte le lampade di Atena Lux sono conformi alle normative obbligatorie in ambito elettrico e possiedono la marcatura CE. La scrupolosa analisi sulla scelta delle materie prime e la concreta e leale collaborazione con i propri fornitori rimangono il punto di partenza per lo sviluppo di prodotti affidabili e sicuri. Tutti gli apparecchi di Atena Lux sono in linea con le normative di riferimento:

All Atena Lux lamps comply with mandatory electrical regulations and have the CE marking. The scrupulous analysis on the choice of raw materials and the concrete and loyal collaboration with its suppliers remain the starting point for the development of reliable and safe products. Atena Lux lighting fittings are made in compliance with the following standards:

EN 55015
 EN 60061-1
 EN 60529
 EN 60598-1
 EN 60598-2-1
 EN 60598-2-2
 EN 60598-2-22
 EN 61000-3-2
 EN 61000-3-3
 EN 61347-1
 EN 61347-2-7
 EN 61347-2-13
 EN 61547
 EN 62031
 EN 62471 (RG0)
 EN 62493
 EN 62560
 IEC/TR 62471-2

LUCE PER OGNI ESIGENZA

Light for every needs

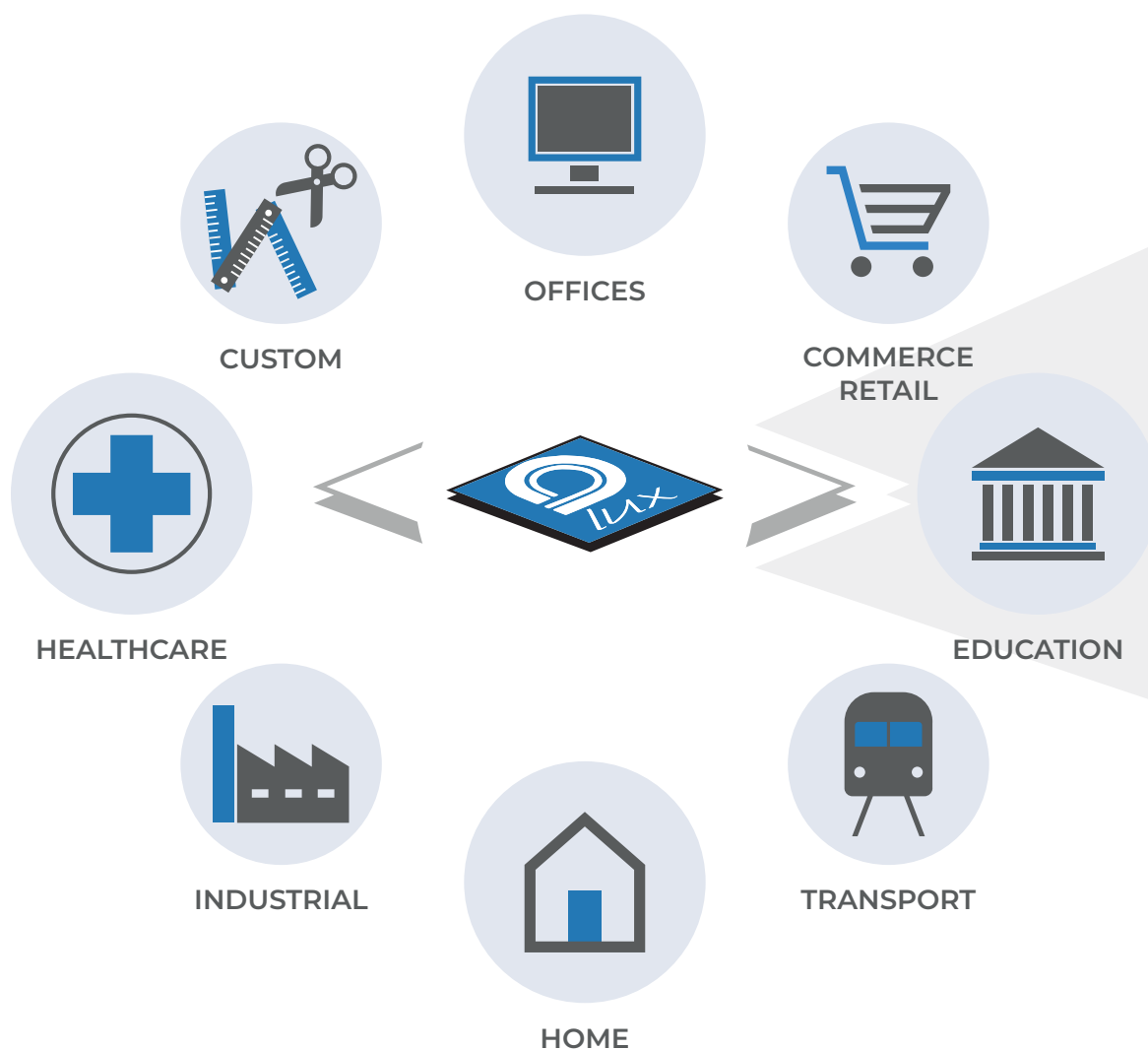

Nel campo dell'illuminazione da oltre 25 anni, Atena Lux inizia il suo percorso come produttore di apparecchi di illuminazione tecnici per ambienti interni. Negli anni acquisisce competenze sempre più specifiche attrezzandosi e rendendosi indipendente nella lavorazione di molteplici materiali.

Oggi Atena Lux dispone di una gamma completa di corpi illuminanti, capace di soddisfare esigenze illuminotecniche legate a molteplici settori, rappresenta inoltre l'eccellenza del Made in Italy nella produzione di travi testaletto per il settore ospedaliero.

La produzione include lampade ad incasso, sospensione e plafone disponibili in svariate tipologie di ottiche e cablaggi, idonee per l'illuminazione di uffici, centri direzionali, centri commerciali, stabilimenti industriali, magazzini, aeroporti, scuole, musei, cliniche e ospedali.

In the lighting field for over 25 years, Atena Lux has started its journey as a manufacturer of technical lighting fittings for indoor use. Over the years it has acquired more specific skills introducing new machineries and becoming independent in the processing of several materials.

Today Atena Lux has a complete range of lighting fittings, capable of satisfying lighting needs related to several sectors, it also represents the excellence of the "Made in Italy" in the production of bedhead units for the hospital sector.

The production includes recessed, suspension and ceiling lamps available in various types of diffusers and wirings, suitable for offices, business centres, shopping malls, industrial plants, warehouses, airports, schools, museums, clinics and hospitals.

MADE IN ITALY

SERVIZIO DI QUALITÀ E AFFIDABILITÀ

Quality and reliability service

Le innumerevoli realizzazioni personalizzate, che sono il fiore all'occhiello della produzione di Atena Lux, sono rese possibili da un sistema produzione molto flessibile. Allo stesso tempo l'efficientamento dei processi produttivi e l'adozione di metodologie di produzione ispirate alle logiche di Lean Manufacturing permettono all'azienda di mantenere uno standard qualitativo ed economico competitivo sul mercato.

La presenza di un laboratorio fotometrico interno rende possibile utilizzare dati sempre aggiornati. Consulenza, sviluppo progettuale e calcolo illuminotecnico sono servizi che l'azienda mette a disposizione e che generano un rapporto di fiducia e continuità con i clienti.

The countless customized productions, which are highlights of Atena Lux production, are possible thanks to a very flexible production system. At the same time, taking inspiration from the Lean Manufacturing logic, the efficiency of production processes and the adoption of new production methods have allowed the company to maintain a competitive quality and economic standard on the market.

Thanks to the presence of an internal photometric laboratory, the data for lighting project elaborations are constantly updated. ATENA LUX has established a continuous relationship based on trust with customers also providing several services for free like consulting, project development and lighting planning calculation.

I BRAND:

SOLUZIONI DI LUCE PER USI SPECIFICI

Brands: Lighting for special uses



Il brand di Atena Lux LUX ET VINUM è interamente dedicata al settore vitivinicolo.

I LED utilizzati in questi corpi illuminanti, selezionati e di qualità, hanno dato vita ad una ampia e completa gamma di corpi illuminanti, funzionali e decorativi al tempo stesso, che tutelano il vino da rischi fotobiologici negli spazi di lavorazione, di conservazione e di commercializzazione.

Atena Lux LUX ET VINUM brand is dedicated to the wine sector.

For this line, the LEDs sources are have been selected in order to create a wide and complete range of lighting fixtures, functional and decorative at the same time, which protect the wine from photobiological risks in the processing, storage and marketing spaces.

Per maggiori informazioni / For more information:
www.luxetvinum.com



Per l'illuminazione delle cliniche dentali e dei laboratori odontotecnici, il brand ÉCLAIRÉ propone un'ampia gamma di lampade a sospensione, plafone e incasso, con sorgenti luminose specifiche e idonee secondo le normative vigenti a una corretta illuminazione di questi particolari ambienti.

For the illumination of dental clinics and dental laboratories, the ÉCLAIRÉ brand offers a wide range of suspended, ceiling and recessed lamps, with specific and suitable light sources, according to the regulations in force, for the correct lighting of these particular environments.

Per maggiori informazioni / For more information:
www.eclairé.it

INDICE

Index

AZIENDA .3
Company

CODICE ETICO E VALORI .4
Code of conduct and values

SVILUPPO SOSTENIBILE .6
Sustainable development

AFFIDABILITÀ .8
Reliability

LUCE PER OGNI ESIGENZA .10
Light for every needs

IN EVIDENZA .18
Highlight



LAMBDA

.20



LAMBDA/S

.20

SISTEMI MODULARI .22
Modular systems

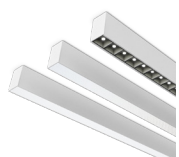

WAY

.24

• WAY

.26

• WAY FRAME

.34

MET

.40

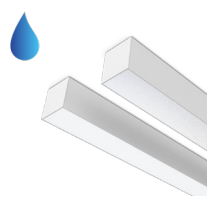

GAP

.42

• GAP

.44

• GAP FRAME

.52

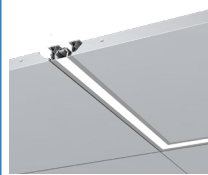

LINK

.58



TOUCH

.62

• TOUCH

.64

• TOUCH IND

.68

• TOUCH I/D

.70



INCASSI

Recessed

.74



TAURUS .80
 • TAURUS/N
 • TAURUS/V
 • TAURUS/EVO
 • TAURUS/TOP

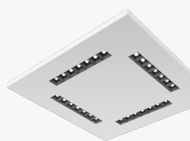

PLAY .92
 • PLAY
 • PLAY/N
 • PLAY/UV



PLAN .98
 • PLAN
 • PLAN/N



ROUND ABOUT .104



MANTA .108



SLIM .110
 • SLIM 2X
 • SLIM 3X



AT/FIRE .114



SKIN .116
 • SKIN.11
 • SKIN.33



4 SIDE .120



DUOLED .122



PLATE .124

INCASSI PER DOGHE

Recessed for staves

.126



AT/1 .128



AT/184 .130



AT/284 .132



AT/20 .134



AT/C 230 .136

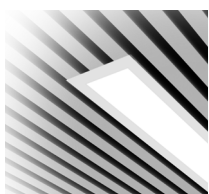

AT/S 180 .140



STREET P/30 .142

IK10
 Grado di protezione da impatti meccanici
 Protection degree against mechanical impacts

IP65 e IP66
 Grado di protezione da corpi solidi e acqua
 Protection degree against foreign solid bodies and water

REI 120
 Resistenza al fuoco
 Fire resistance

PLAFONE E SOSPENSIONE

Ceiling and suspension

.146



TAURUS/P .148



PLAN/P .150



MANTA/P .152



DUOLED/P .154

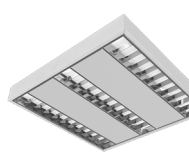

SLIM/P .156
• SLIM/P 2X
• SLIM/P 3X



LEDCUBE .158

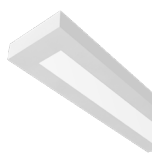

BLOCK .160



PLEXI .164

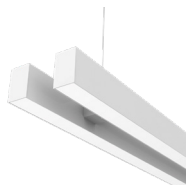

WAY 2-LINE .166

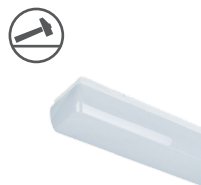

AT/PRISMA .170
• AT/PRISMA 1X
• AT/PRISMA 2X

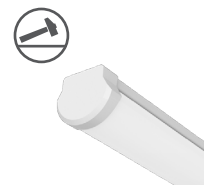

MIRROR .172
• MIRROR 1X
• MIRROR 2X



KOLED .174

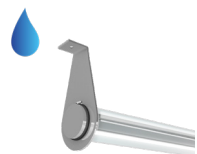

TUKOON .176



STIKKY .178



CIRCLE .180



COSMO .184

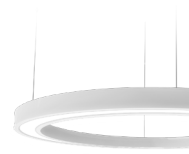

PIGRECO .188

TERRA E PARETE

Floor and wall

.190

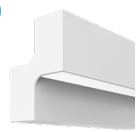

STAIR .192

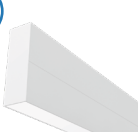

WAY WALL .194

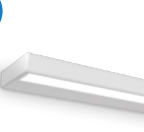

SKYWALL .196



HORIZON .198

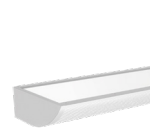

VENUS .200



JELLY .202



TONDO/QUADRO .204
• TONDO L
• QUADRO L



PILL .206
• PILL
• PILL R



COURTESY .208



WAY UP .210



WAY UP++ .212



INDUSTRIALE

Industrial

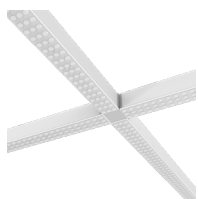

SUPERLITE .216

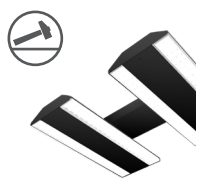

LUMIFORCE .220

- 1X
- 2X



MACH .222

- MACH
- MACH EXTREME



TEKNO .224



IGLOO .226



IGLOO INOX .228

- INOX
- INOX EXTREME

DOWNLIGHTS



PEARL ECO .232

- PEARL ECO
- PEARL ECO/Q



GIOVE .234

- GIOVE
- GIOVE Q



DISQUE .240

- DISQUE
- DISQUE Q



LDR .242



DWN UGR .243



VISUAL .244

- VISUAL
- VISUAL Q



SHADE .248



RAIN .250



POINT .252

- POINT/R
- POINT/R ADJ
- POINT/R ADJ FR.
- POINT/S
- POINT/S ADJ
- POINT/S ADJ FR.



PEARL ECO ADJ .260



TWIST .262



SPY .264



SD016 .266



MINI .268

- MINI R
- MINI Q

PITTOGRAMMI

Pictograms

CONDIZIONI GENERALI DI VENDITA

General sale conditions



LAMBDA

Arch. Nicole Filippi Designer





THE LIGHT
that belongs
to You 

Lambda rappresenta un nuovo modo di fare illuminazione: un concept che offre molteplici soluzioni per l'illuminazione di spazi residenziali, uffici e musei. Luce ergonomica e sicura: questa collezione utilizza moduli LED ad aggancio magnetico su binario a bassissima tensione (48V). Dettagli raffinati e colori moderni rendono questi corpi illuminanti unici e insostituibili.

Lambda represents a new way of lighting: a concept that offers multiple solutions for lighting in residential spaces, offices and museums.

Ergonomic and safe light: this collection uses magnetic hook LED modules on very low voltage track (48V). Refined details and modern colours make these lighting fittings unique and irreplaceable.

Crea la tua LAMBDA

Create your LAMBDA

48
Vdc

In evidenza | Highlight

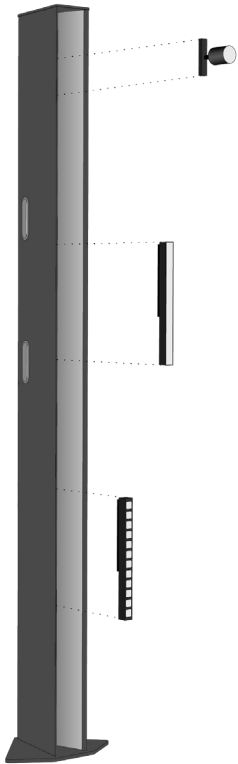

SPOTLIGHT

Proiettore con apertura di fascio a 15° o 30°, diffusore con lente in policarbonato
Spotlight with 15° or 30° beam, polycarbonate lens



IRC>90

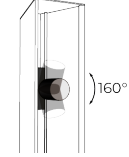

OPAL

Modulo lineare con diffusore in policarbonato opale
Linear module with polycarbonate diffuser



IRC>90

UGR<19

Modulo lineare con ottica ad abbagliamento controllato
Linear module with glare controlled optical diffuser



IRC>90

LAMBDA Living



- 1 15°
- 2 30°
- 3



LAMBDA Work

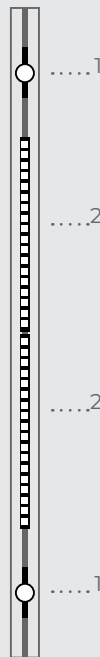

- 1 30°
- 2
- 1



LAMBDA Art



- 1 15°
- 2
- 1 30°

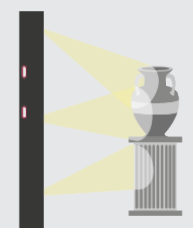

Le soluzioni sopra riportate rappresentano configurazioni standard e possono essere personalizzate secondo esigenze specifiche. Per le soluzioni personalizzate vi preghiamo di contattare il nostro ufficio commerciale.
The above indicated solutions represent standard versions and they can be custom-made according to particular exigencies. For custom solutions please contact our Sales Department.

Personalizzazioni cromatiche

Color customizations

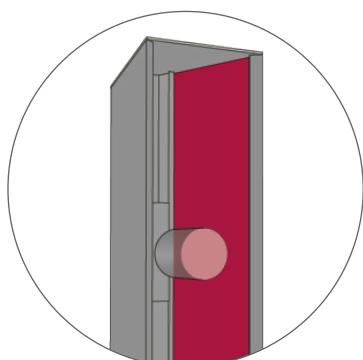

Riflettore interno
in alluminio verniciato
Sheet-steel powder coated
internal reflector

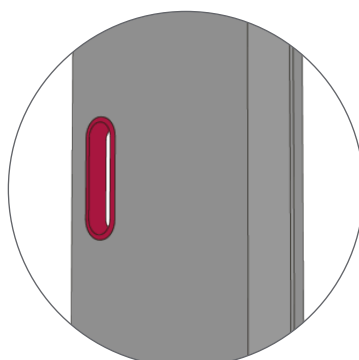

Maniglie
poli carbonato
Polycarbonate
handle

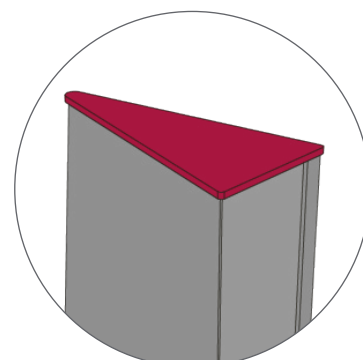

Testate di chiusura
poli carbonato
Polycarbonate
closing caps

	Corpo <i>Body</i>	Riflettore <i>Reflector</i>	Maniglia <i>Handle</i>	Testata <i>Closing cap</i>
STANDARD				
SABLE GREY	●	●	●	●
RAL				
5023	-	●	●	●
5020	-	●	●	●
6027	-	●	●	●
1003	-	●	●	●
2000	-	●	●	●
3002	-	●	●	●
9018	-	●	●	●
METAL				
COPPER SHINE	-	●	-	-
JOY GOLD	-	●	-	-
TITAN LUX	-	●	-	-

Lambda

IP20

UGR <19

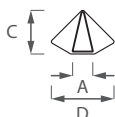

Lambda/S

IP20

UGR <19

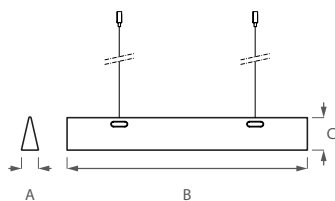

Caratteristiche tecniche

Technical Characteristics

Corpo	<ul style="list-style-type: none"> Profilo estruso in alluminio Base in acciaio 	Body	<ul style="list-style-type: none"> Extruded aluminium profile Sheet-steel base
Colore	<ul style="list-style-type: none"> ● Sable Grey <p>Su richiesta: ● Altri colori (pag.17)</p>	Colour	<ul style="list-style-type: none"> ● Sable Grey <p>On request: ● Other colours available (pag.17)</p>
Cablaggio	<ul style="list-style-type: none"> LED ON/OFF (Binario a bassissima tensione 48 Vdc ad aggancio magnetico) 	Wiring	<ul style="list-style-type: none"> LED ON/OFF (Low voltage track 48 Vdc with magnetic hooking)
Grado di protezione	IP 20	Protection degree	IP 20

Dimensioni

Dimensions

LAMBDA		LAMBDA/S		
A	100	A	100	
B	1800	B	1200	1800 3000
C	200	C	200	
D	325			

Caratteristiche sorgenti luminose

Light sources characteristics

		Potenza	Temp. colore	IRC	Flusso lum.	Efficienza lum.	Dimensioni /
		Power [W]	Colour Temp. [K]	CRI	Lum. flux [lm]	Lum. effic. [lm / W]	Dimensions [mm]
		8	3000	>90	895	111	L
		8	4000	>90	950	118	170
		8	3000	>90	895	111	170
		8	4000	>90	950	118	170
		6	3000	>90	744	124	286
		6	4000	>90	810	135	286
		11	3000	>90	1488	135	567
		11	4000	>90	1620	147	567
		6	3000	>90	579	96	286
		6	4000	>90	620	103	286
		11	3000	>90	1159	105	567
		11	4000	>90	1241	113	567



SISTEMI MODULARI *MODULAR SYSTEMS*

Way

Sistema modulare composto da un profilo in estruso di alluminio utilizzabile sia **singolarmente** che in **fila continua** per realizzare tagli di luce senza interruzioni.

Modular system made of extruded aluminium profiles suitable to be used **individually** or to create **continuous row lighting systems**.

Way

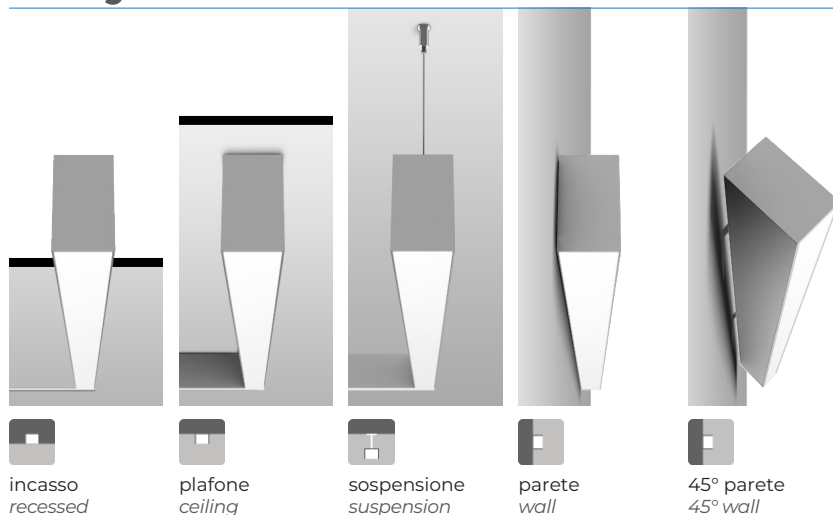

Way Frame



Giunti luminosi / Luminous joints

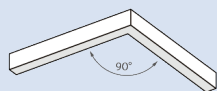

Angolo 90°
90° corner

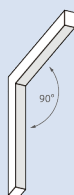

Angolo 90° parete/soffitto
90° wall/ceiling corner

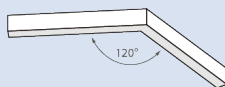

Angolo 120°
120° corner

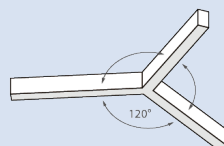

Giunto ad Y
Y joint

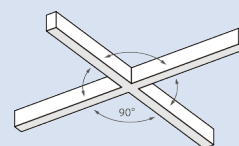

Giunto ad X
X joint

Gruppi ottici

Optical groups

OFC

Ottica composta da lenti modulari con cover nera ad emissione luminosa controllata. Valori di luminanza <math>< 200 \text{ cd/m}^2</math> per angoli >math>65^\circ</math>.

Conforme ad essere installata in ambienti con uso di videotermini secondo la norma UNI EN 12464-1.

Optics composed of modular lenses with black cover and controlled light emission. Luminance values <math>< 200 \text{ cd/m}^2</math> for angles >math>65^\circ</math>.

Suitable for installation in workplaces with the use of video terminals according to EN 12464-1 standard.

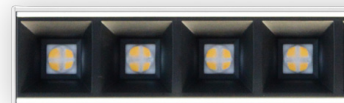
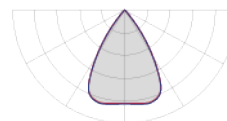

UGR <math>< 16</math>

OFC80

Ottica composta da lenti modulari con cover nera ad emissione luminosa controllata. Apertura di fascio 80° . Valori di luminanza <math>< 200 \text{ cd/m}^2</math> per angoli >math>65^\circ</math>.

Conforme ad essere installata in ambienti con uso di videotermini secondo la norma UNI EN 12464-1.

Optics composed of modular lenses with black cover and with controlled light emission. 80° beam angle. Luminance values <math>< 200 \text{ cd/m}^2</math> for angles >math>65^\circ</math>.

Suitable for installation in workplaces with the use of video terminals according to EN 12464-1 standard.

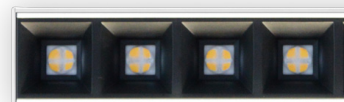
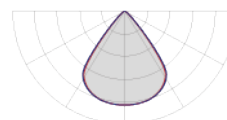

UGR <math>< 19</math>

PMO

Diffusore in policarbonato microprismatico anabbagliante. Valori di luminanza <math>< 3000 \text{ cd/m}^2</math> per angoli >math>65^\circ</math>. Film interno in policarbonato opale anabbagliante per una maggiore uniformità luminosa. Conforme ad essere installata in ambienti con uso di videotermini secondo la norma UNI EN 12464-1.

Diffuser made of anti-glare microprismatic polycarbonate. Luminance values <math>< 3000 \text{ cd/m}^2</math> for angles >math>65^\circ</math>. Internal anti-glare opal polycarbonate film for a better light uniformity.

Suitable for installation in workplaces with the use of video terminals according to EN 12464-1 standard.

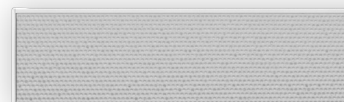
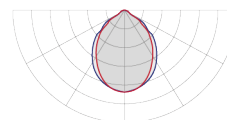

UGR <math>< 19</math>

PST

Diffusore in policarbonato opale satinato a finitura liscia, ideale per una distribuzione uniforme.

Diffuser in glazed opal polycarbonate with smooth finish, ideal for uniform distribution.

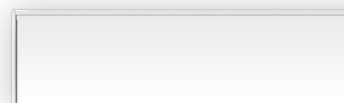
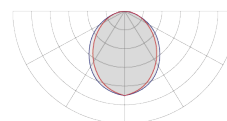

Way

IP40

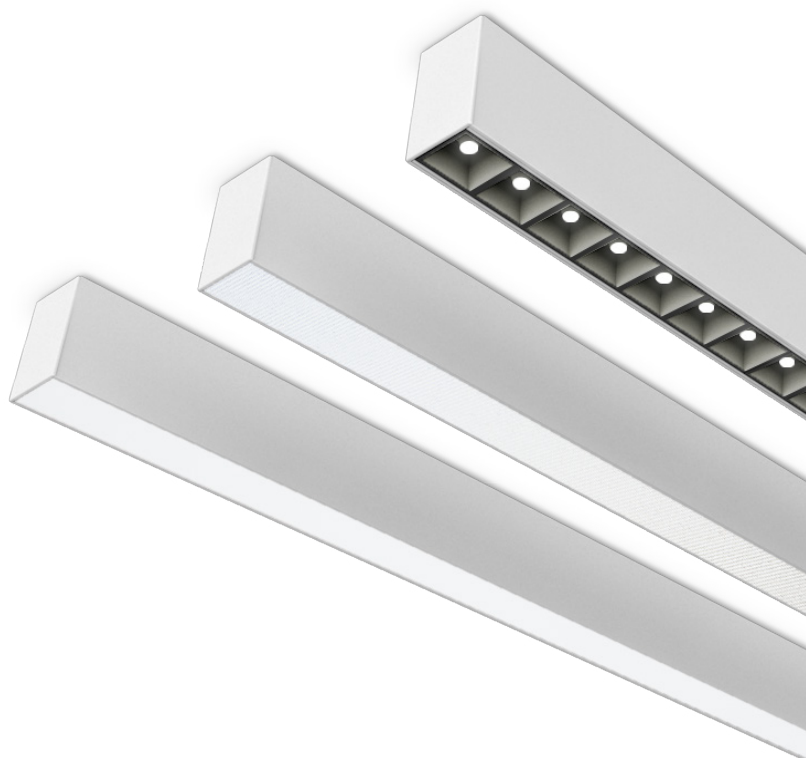
UGR
<16UGR
<19

Caratteristiche tecniche

Technical Characteristics

Corpo	Profilo estruso in alluminio	Body	Extruded aluminium profile
Colore	<input type="radio"/> Bianco Dry <u>Su richiesta:</u> <input checked="" type="radio"/> Altri colori	Colour	<input type="radio"/> Dry white <u>On request:</u> <input checked="" type="radio"/> Other colours available
Gruppo ottico	<ul style="list-style-type: none"> • OFC - lenti modulari (50°), cover nera (UGR<19) • OFC80 - lenti modulari (80°), cover nera (UGR<16) • PMO - policarbonato microprismatico (UGR<19) • PST - policarbonato opale satinato <u>Su richiesta:</u> <ul style="list-style-type: none"> • OFC.B - lenti modulari (50°), cover bianca (UGR<19) • OFC80.B - lenti modulari (80°), cover bianca (UGR<16) 	Optical group	<ul style="list-style-type: none"> • OFC - modular lenses (50°), black cover (UGR<19) • OFC80 - modular lenses (80°), black cover (UGR<16) • PMO - microprismatic polycarbonate (UGR<19) • PST - glazed opal polycarbonate <u>On request:</u> <ul style="list-style-type: none"> • OFC.B - modular lenses (50°), white cover (UGR<19) • OFC80.B - modular lenses (80°), white cover (UGR<16)
Cablaggio	<ul style="list-style-type: none"> • LED ON/OFF con driver integrato • LED DALI con driver integrato <u>Su richiesta:</u> <ul style="list-style-type: none"> • Circuito RGB • Kit di EMERGENZA (autonomia 1/3 h) 	Wiring	<ul style="list-style-type: none"> • LED ON/OFF with integrated driver • LED DALI with integrated driver <u>On request:</u> <ul style="list-style-type: none"> • RGB circuit • EMERGENCY kit (1/3 h autonomy)
Grado di protezione	IP 40	Protection degree	IP 40

Sorgenti LED

LED sources

IRC	<ul style="list-style-type: none"> • >80 <u>Su richiesta:</u> <ul style="list-style-type: none"> • >90 	CRI	<ul style="list-style-type: none"> • >80 <u>On request:</u> <ul style="list-style-type: none"> • >90
Temp. colore	<ul style="list-style-type: none"> • 3000 K • 4000 K <u>Su richiesta:</u> <ul style="list-style-type: none"> • TUNABLE WHITE 2700-6500 K • LED RGB 	Colour Temp.	<ul style="list-style-type: none"> • 3000 K • 4000 K <u>On request:</u> <ul style="list-style-type: none"> • TUNABLE WHITE 2700-6500 K • RGB LED

01 Accessori Accessories



**TESTATE DI CHIUSURA
END CAPS**
Cod. / Code TC660004
Alluminio verniciato di colore bianco Dry.
Dry white powder coated aluminium.

2 pcs. kit



**STAFFA D'UNIONE
UNION BRACKET**
Cod. / Code KFS660000
Per l'installazione in linea continua, in acciaio zincato. Completo di viti di fissaggio.
Galvanized steel union bracket for continuous line installation. Fixing screws included.

1 pcs. kit

Incasso / Recessed



**STAFFA PER INSTALLAZIONE A FILO
CARTONGESSO
PLASTERBOARD FLUSH MOUNTING
INSTALLATION BRACKET**
Cod. / Code KFC660000
Lamiera di acciaio zincato.
Galvanized steel sheet.

3 pcs. kit

Sospensione / Suspension



L= 2000 mm

**CAVO DI SOSPENSIONE
SUSPENSION CABLE**
Cod. / Code KS012
È necessario ordinare 2 pz per ogni lampada.
It is necessary to order 2 pcs. for each lamp.



L= 2000 mm
Ø 0,75 mmq

**CAVO DI ALIMENTAZIONE TRASPARENTE
TRANSPARENT ELECTRIFIED FEEDING
CABLE**
Cod. / Code CVTXX075L020

- 3 poli (ON/OFF)/poles (ON/OFF)
- 5 poli (DALI e ON/OFF + emergenza)/ poles (DALI and ON/OFF + emergency)
- 7 poli (DALI + emergenza)/ poles (DALI + emergency)



**ROSONE QUADRATO ELETRIFICATO
ELECTRIFIED SQUARE CEILING ROSE**
Cod. / Code KS02504E
Lamiera d'acciaio verniciato di colore bianco dry, 2 fori per il passaggio del cavo di alimentazione e di sospensione con morsettiera di connessione.
Powder coated in white dry colour sheet-steel, 2 holes for the passage of transparent power cable and suspension cable, with terminal block.

Parete / Wall



3 pcs. kit

**STAFFA DI FISSAGGIO A 90°
90° WALL BRACKET**
Cod. / Code KPR660004
Lamiera di acciaio zincato, verniciata bianco Dry. Completo di viti di fissaggio.
Galvanized steel sheet, dry white powder coated. Fixing screws included.



3 pcs. kit

**STAFFA DI FISSAGGIO A 45°
45° WALL BRACKET**
Cod. / Code KP4660004
Lamiera di acciaio zincato, verniciata bianco Dry. Completo di viti di fissaggio.
Galvanized steel sheet, dry white powder coated. Fixing screws included.

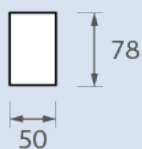

Lineare Linear

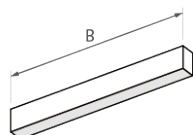

B
[mm]
561
1121
1681
2241
2801

Angolo parete/soffitto 90° 90° wall/ceiling corner

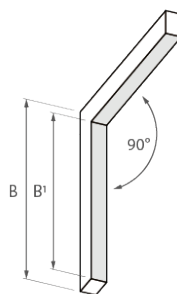

	B	B ¹
	[mm]	
OFC	-	-
PMO	615	537
PST	615	537

Angolo 90° 90° corner

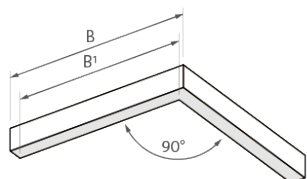

	B	B ¹
	[mm]	
OFC	610	560
PMO	595	545
PST	595	545

Angolo 120° 120° corner

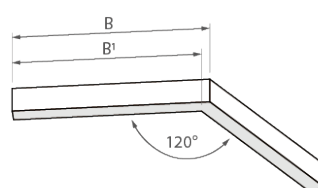

	B	B ¹
	[mm]	
OFC	590	561
PMO	580	551
PST	580	551

Giunto luminoso ad Y Y luminous joint

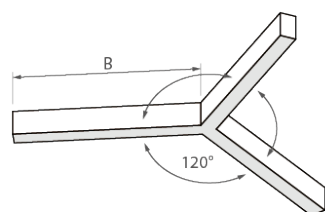

	B
	[mm]
OFC	-
PMO	550
PST	550

Giunto luminoso ad X X luminous joint

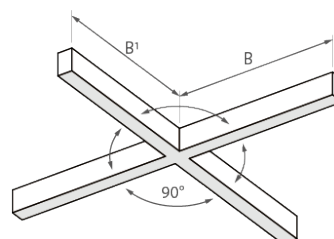

	B	B ¹
	[mm]	
OFC	-	-
PMO	545	545
PST	545	545

Le dimensioni fanno riferimento al solo modulo escluse le testate di inizio e fine linea (+3mm cad.).
 Aggiungere + 5mm alla somma totale della lunghezza di tutti i moduli posti in fila continua.
 Dimensions refer to the module without the two end caps (+3mm each).
 Add +5mm to the total length of the continuous row lighting system..



OFC

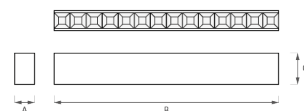
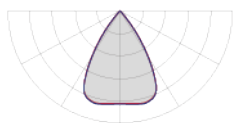

Potenza Power [W]	Temp. colore Colour Temp. [K]	IRC CRI	Flusso lum. Lum. flux [lm]	Efficienza lum. Lum. effic. [lm / W]	Dimensioni / Dimensions [mm]						Cod. / Code LED	Cod. / Code LED DALI
					A	B	C	D	E	F		
Lineare / Linear												
16	3000	>80	2528	158	50	561	78	-	-	-	660001043	660001045
16	4000	>80	2632	165	50	561	78	-	-	-	660001044	660001046
32	3000	>80	5056	158	50	1121	78	-	-	-	660001051	660001053
32	4000	>80	5280	165	50	1121	78	-	-	-	660001052	660001054
48	3000	>80	7584	158	50	1681	78	-	-	-	660001059	660001061
48	4000	>80	7920	165	50	1681	78	-	-	-	660001060	660001062
65	3000	>80	10270	158	50	2241	78	-	-	-	660001063	660001065
65	4000	>80	10725	165	50	2241	78	-	-	-	660001064	660001066
81	3000	>80	12798	158	50	2801	78	-	-	-	660001067	660001069
81	4000	>80	13365	165	50	2801	78	-	-	-	660001068	660001070
Modulo Luce+Cieco / Light+Infill Module												
8	3000	>80	1264	158	50	561	78	280	280	-	660001071	660001073
8	4000	>80	1320	165	50	561	78	280	280	-	660001072	660001074
Modulo Luce+Cieco+Luce / Light+Infill+Light Module												
16	3000	>80	2528	158	50	841	78	280	280	-	660001075	660001077
16	4000	>80	2632	165	50	841	78	280	280	-	660001076	660001078
16	3000	>80	2528	158	50	1121	78	280	561	-	660001079	660001081
16	4000	>80	2632	165	50	1121	78	280	561	-	660001080	660001082
48	3000	>80	7584	158	50	2241	78	840	561	-	660001091	660001093
48	4000	>80	7920	165	50	2241	78	840	561	-	660001092	660001094
48	3000	>80	7584	158	50	2801	78	840	1121	-	660001095	660001097
48	4000	>80	7920	165	50	2801	78	840	1121	-	660001096	660001098
Modulo Luce+Cieco+Luce+Cieco+Luce / Light+Infill+Light+Infill+Light Module												
24	3000	>80	3792	158	50	1401	78	280	280	281	660001083	660001085
24	4000	>80	3960	165	50	1401	78	280	280	281	660001084	660001086
32	3000	>80	5056	158	50	1681	78	280	280	561	660001087	660001089
32	4000	>80	5280	165	50	1681	78	280	280	561	660001088	660001090
Angolo 90° / 90° corner												
32	3000	>80	5056	158	50	610	78	-	-	-	660001099	660001101
32	4000	>80	5280	165	50	610	78	-	-	-	660001100	660001102
Angolo 120° / 120° corner												
32	3000	>80	5056	158	50	590	78	-	-	-	660001103	660001105
32	4000	>80	5280	165	50	590	78	-	-	-	660001104	660001106

(III)

Angolo 90° / 90° corner

(III)

Angolo 120° / 120° corner

I) Il flusso effettivo potrebbe avere una tolleranza del ±10%. / The effective flux could have a tolerance of ±10%.

II) Le dimensioni fanno riferimento al solo modulo, escluse le testate di inizio e fine linea (+3mm cad.) / Dimensions refer to the module without the two end caps (+3mm each).

III) Dimensioni complete a pag. 28 / Full dimension on page 28

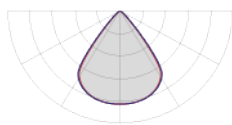
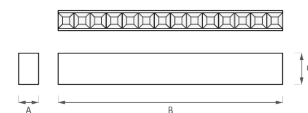

OFC80



Potenza Power [W]	Temp. colore Colour Temp. [K]	IRC CRI	Flusso lum. Lum. flux [lm]	Efficienza lum. Lum. effic. [lm / W]	Dimensioni / Dimensions [mm]						Cod. / Code LED	Cod. / Code LED DALI
					A	B	C	D	E	F		
Lineare / Linear												
16	3000	>80	2528	158	50	561	78	-	-	-	660001280	660001283
16	4000	>80	2632	165	50	561	78	-	-	-	660001286	660001289
32	3000	>80	5056	158	50	1121	78	-	-	-	660001304	660001307
32	4000	>80	5280	165	50	1121	78	-	-	-	660001310	660001313
48	3000	>80	7584	158	50	1681	78	-	-	-	660001328	660001331
48	4000	>80	7920	165	50	1681	78	-	-	-	660001334	660001337
65	3000	>80	10270	158	50	2241	78	-	-	-	660001340	660001343
65	4000	>80	10725	165	50	2241	78	-	-	-	660001346	660001349
81	3000	>80	12798	158	50	2801	78	-	-	-	660001352	660001355
81	4000	>80	13365	165	50	2801	78	-	-	-	660001358	660001361
Modulo Luce+Cieco / Light+Infill Module												
8	3000	>80	1264	158	50	561	78	280	280	-	660001364	660001367
8	4000	>80	1320	165	50	561	78	280	280	-	660001370	660001373
Modulo Luce+Cieco+Luce / Light+Infill+Light Module												
16	3000	>80	2528	158	50	841	78	280	280	-	660001376	660001379
16	4000	>80	2632	165	50	841	78	280	280	-	660001382	660001385
16	3000	>80	2528	158	50	1121	78	280	561	-	660001388	660001391
16	4000	>80	2632	165	50	1121	78	280	561	-	660001394	660001397
48	3000	>80	7584	158	50	2241	78	840	561	-	660001424	660001427
48	4000	>80	7920	165	50	2241	78	840	561	-	660001430	660001433
48	3000	>80	7584	158	50	2801	78	840	1121	-	660001436	660001439
48	4000	>80	7920	165	50	2801	78	840	1121	-	660001442	660001445
Modulo Luce+Cieco+Luce+Cieco+Luce / Light+Infill+Light+Infill+Light Module												
24	3000	>80	3792	158	50	1401	78	280	280	281	660001400	660001403
24	4000	>80	3960	165	50	1401	78	280	280	281	660001406	660001409
32	3000	>80	5056	158	50	1681	78	280	280	561	660001412	660001415
32	4000	>80	5280	165	50	1681	78	280	280	561	660001418	660001421
Angolo 90° / 90° corner												
32	3000	>80	5056	158	50	610	78	-	-	-	660001448	660001451
32	4000	>80	5280	165	50	610	78	-	-	-	660001454	660001457
Angolo 120° / 120° corner												
32	3000	>80	5056	158	50	590	78	-	-	-	660001460	660001463
32	4000	>80	5280	165	50	590	78	-	-	-	660001466	660001469

(iii)

I) Il flusso effettivo potrebbe avere una tolleranza del ±10%. / The effective flux could have a tolerance of ±10%.

II) Le dimensioni fanno riferimento al solo modulo, escluse le testate di inizio e fine linea (+3mm cad.) / Dimensions refer to the module without the two end caps (+3mm each).

III) Dimensioni complete a pag. 28 / Full dimension on page 28

PMO

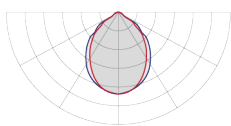

Potenza Power [W]	Temp. colore Colour Temp. [K]	IRC CRI	Flusso lum. Lum. flux [lm]	Efficienza lum. Lum. effic. [lm / W]	Dimensioni / Dimensions [mm]			Cod. / Code LED	Cod. / Code LED DALI
					A	B	C		
Lineare / Linear module									
13	3000	>80	1092	84	50	561	78	660000927	660000928
13	4000	>80	1170	90	50	561	78	660000929	660000930
26	3000	>80	2184	84	50	1121	78	660000931	660000932
26	4000	>80	2340	90	50	1121	78	660000933	660000934
39	3000	>80	3276	84	50	1681	78	660000935	660000936
39	4000	>80	3510	90	50	1681	78	660000937	660000938
52	3000	>80	4368	84	50	2241	78	660000939	660000940
52	4000	>80	4680	90	50	2241	78	660000941	660000942
65	3000	>80	5460	84	50	2801	78	660000943	660000944
65	4000	>80	5850	90	50	2801	78	660000945	660000946
Angolo 90° / 90° corner									
26	3000	>80	2184	84	50	595	78	660001011	660001012
26	4000	>80	2340	90	50	595	78	660001013	660001014
Angolo parete-soffitto 90° / 90° wall-ceiling corner									
26	3000	>80	2184	84	50	615	78	660001015	660001016
26	4000	>80	2340	90	50	615	78	660001017	660001018
Angolo 120° / 120° corner									
26	3000	>80	2184	84	50	580	78	660001019	660001020
26	4000	>80	2340	90	50	580	78	660001021	660001022
Giunto Y / Y joint									
39	3000	>80	3276	84	50	550	78	660001023	660001024
39	4000	>80	3510	90	50	550	78	660001025	660001026
Giunto X / X joint									
52	3000	>80	4368	84	50	545	78	660001027	660001028
52	4000	>80	4680	90	50	545	78	660001029	660001030

I) Il flusso effettivo potrebbe avere una tolleranza del $\pm 10\%$. / The effective flux could have a tolerance of $\pm 10\%$.

II) Le dimensioni fanno riferimento al solo modulo, escluse le testate di inizio e fine linea (+3mm cad.) / Dimensions refer to the module without the two end caps (+3mm each).

III) Dimensioni complete a pag. 28 / Full dimension on page 28



PST

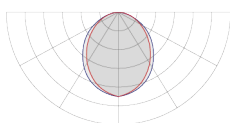

Potenza Power [W]	Temp. colore Colour Temp. [K]	IRC CRI	Flusso lum. Lum. flux [lm]	Efficienza lum. Lum. effic. [lm / W]	Dimensioni / Dimensions [mm]			Cod. / Code LED	Cod. / Code LED DALI
					A	B	C		
Lineare / Linear module									
13	3000	>80	1105	85	50	561	78	660000891	660000892
13	4000	>80	1183	91	50	561	78	660000893	660000894
26	3000	>80	2210	85	50	1121	78	660000897	660000898
26	4000	>80	2366	91	50	1121	78	660000895	660000896
39	3000	>80	3315	85	50	1681	78	660000899	660000900
39	4000	>80	3549	91	50	1681	78	660000901	660000902
52	3000	>80	4420	85	50	2241	78	660000903	660000904
52	4000	>80	4732	91	50	2241	78	660000905	660000906
65	3000	>80	5525	85	50	2801	78	660000907	660000908
65	4000	>80	5915	91	50	2801	78	660000909	660000910
Angolo 90° / 90° corner									
26	3000	>80	2184	84	50	595	78	660000992	660000993
26	4000	>80	2340	90	50	595	78	660000994	660000995
Angolo parete-soffitto 90° / 90° wall-ceiling corner									
26	3000	>80	2184	84	50	615	78	660000996	660000997
26	4000	>80	2340	90	50	615	78	660000707	660000998
Angolo 120° / 120° corner									
26	3000	>80	2184	84	50	580	78	660000999	66001000
26	4000	>80	2340	90	50	580	78	66001001	66001002
Giunto Y / Y joint									
39	3000	>80	3276	84	50	550	78	66001003	66001004
39	4000	>80	3510	90	50	550	78	66001005	66001006
Giunto X / X joint									
52	3000	>80	4368	84	50	545	78	66001007	66001008
52	4000	>80	4680	90	50	545	78	66001009	66001010

I) Il flusso effettivo potrebbe avere una tolleranza del ±10%. / The effective flux could have a tolerance of ±10%.

II) Le dimensioni fanno riferimento al solo modulo, escluse le testate di inizio e fine linea (+3mm cad.) / Dimensions refer to the module without the two end caps (+3mm each).

III) Dimensioni complete a pag. 28 / Full dimension on page 28

Way Frame

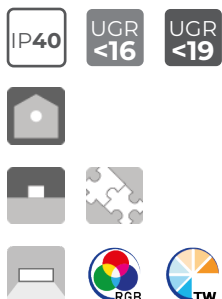

Caratteristiche tecniche

Technical Characteristics

Corpo	Profilo estruso in alluminio	Body	Extruded aluminium profile
Colore	<input type="radio"/> Bianco Dry Su richiesta: <input checked="" type="radio"/> Altri colori	Colour	<input type="radio"/> Dry white On request: <input checked="" type="radio"/> Other colours available
Gruppo ottico	<ul style="list-style-type: none"> • OFC - lenti modulari (50°), cover nera (UGR<19) • OFC80 - lenti modulari (80°), cover nera (UGR<16) • PMO - policarbonato microprismatico (UGR<19) • PST - policarbonato opale satinato Su richiesta: <ul style="list-style-type: none"> • OFC.B - lenti modulari (50°), cover bianca (UGR<19) • OFC80.B - lenti modulari (80°), cover bianca (UGR<16) 	Optical group	<ul style="list-style-type: none"> • OFC - modular lenses (50°), black cover (UGR<19) • OFC80 - modular lenses (80°), black cover (UGR<16) • PMO - microprismatic polycarbonate (UGR<19) • PST - glazed opal polycarbonate On request: <ul style="list-style-type: none"> • OFC.B - modular lenses (50°), white cover (UGR<19) • OFC80.B - modular lenses (80°), white cover (UGR<16)
Cablaggio	<ul style="list-style-type: none"> • LED ON/OFF con driver integrato • LED DALI con driver integrato Su richiesta: <ul style="list-style-type: none"> • Circuito RGB • Kit di EMERGENZA (autonomia 1/3 h) 	Wiring	<ul style="list-style-type: none"> • LED ON/OFF with integrated driver • LED DALI with integrated driver On request: <ul style="list-style-type: none"> • RGB circuit • EMERGENCY kit (1/3 h autonomy)
Grado di protezione	IP 40	Protection degree	IP 40

Sorgenti LED

LED sources

IRC	>80 Su richiesta: • >90	CRI	>80 On request: • >90
Temp. colore	<ul style="list-style-type: none"> • 3000 K • 4000 K Su richiesta: <ul style="list-style-type: none"> • TUNABLE WHITE 2700-6500 K • LED RGB 	Colour Temp.	<ul style="list-style-type: none"> • 3000 K • 4000 K On request: <ul style="list-style-type: none"> • TUNABLE WHITE 2700-6500 K • RGB LED

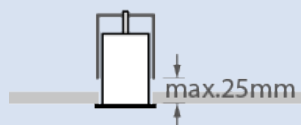
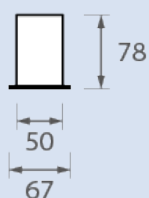

Lineare Linear

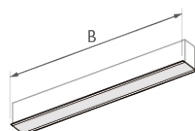

B		
[mm]		
561	561x55	
1121	1121x55	
1681	1681x55	
2241	2241x55	
2801	2801x55	

Angolo parete/soffitto 90° 90° wall/ceiling corner

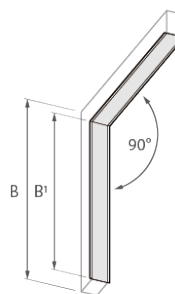

B	B¹	
[mm]		
OFC	-	-
PMO	620	540 542x542x55
PST	620	540 542x542x55

Angolo 90° 90° corner

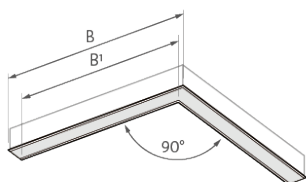

B	B¹	
[mm]		
OFC	-	-
PMO	600	533 592x542x55
PST	600	533 592x542x55

Angolo 120° 120° corner

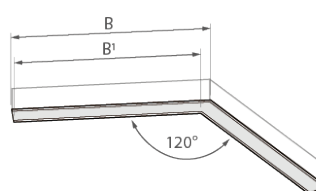

B	B¹	
[mm]		
OFC	-	-
PMO	585	546 582x552x55
PST	585	546 582x552x55

Giunto luminoso ad Y Y luminous joint

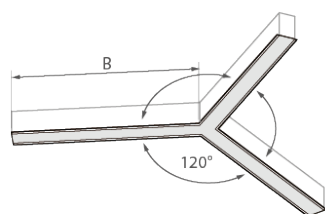

B	B¹	
[mm]		
OFC	-	-
PMO	545	533 552x55
PST	545	533 552x55

Giunto luminoso ad X X luminous joint

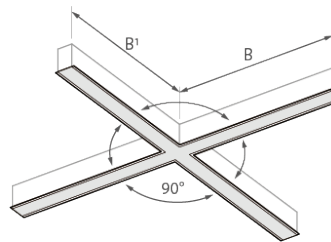

B	B¹	
[mm]		
OFC	-	-
PMO	535	546 545x55
PST	535	546 545x55

Accessori (da ordinare separatamente) Accessories (to be ordered separately)



2 pcs. kit

TESTATE DI CHIUSURA END CAPS

Cod. / Code TC661004

Lamiera d'acciaio verniciato di colore bianco Dry. Completo di viti di fissaggio.

Dry white powder coated sheet-steel. Fixing screws included.



2 pcs. kit

STAFFA D'UNIONE UNION BRACKET

Cod. / Code KFS661000

Per l'installazione in linea continua, in acciaio zincato.

Galvanized steel union bracket for continuous line installation.

Le dimensioni fanno riferimento al solo modulo, escluse le testate di inizio e fine linea (+10mm cad.).
 Aggiungere + 5mm alla somma totale della lunghezza di tutti i moduli posti in fila continua.
 Dimensions refer to the module without the two end caps (+10mm each).
 Add +5mm to the total length of the continuous row lighting system

OFC

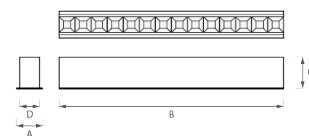
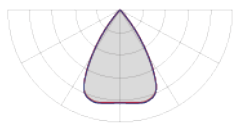

Potenza Power [W]	Temp. colore Colour Temp. [K]	IRC CRI	Flusso lum. Lum. flux [lm]	Eff. lum. Lum. effic. [lm / W]	Dimensioni / Dimensions [mm]								Cod. / Code LED	Cod. / Code LED DALI
					A	B	C	D	E	F	G			
Lineare / Linear														
8	3000	>80	1264	158	67	281	78	50	-	-	-	281x55	661000809	661000811
8	4000	>80	1316	165	67	281	78	50	-	-	-	281x55	661000810	661000812
16	3000	>80	2528	158	67	561	78	50	-	-	-	561x55	661000813	661000815
16	4000	>80	2632	165	67	561	78	50	-	-	-	561x55	661000814	661000816
32	3000	>80	5056	158	67	1121	78	50	-	-	-	1121x55	661000821	661000823
32	4000	>80	5280	165	67	1121	78	50	-	-	-	1121x55	661000822	661000824
48	3000	>80	7584	158	67	1681	78	50	-	-	-	1681x55	661000829	661000831
48	4000	>80	7920	165	67	1681	78	50	-	-	-	1681x55	661000830	661000832
65	3000	>80	10270	158	67	2241	78	50	-	-	-	2241x55	661000833	661000835
65	4000	>80	10725	165	67	2241	78	50	-	-	-	2241x55	661000834	661000836
81	3000	>80	12798	158	67	2801	78	50	-	-	-	2801x55	661000837	661000839
81	4000	>80	13365	165	67	2801	78	50	-	-	-	2801x55	661000838	661000840
Modulo Luce+Cieco / Light+Infill Module														
8	3000	>80	1264	158	67	561	78	50	280	281	-	561x55	661000841	661000843
8	4000	>80	1320	165	67	561	78	50	280	281	-	561x55	661000842	661000844
Modulo Luce+Cieco+Luce / Light+Infill+Light Module														
16	3000	>80	2528	158	67	841	78	50	280	281	-	841x55	661000845	661000847
16	4000	>80	2632	165	67	841	78	50	280	281	-	841x55	661000846	661000848
16	3000	>80	2528	158	67	1121	78	50	280	561	-	1121x55	661000849	661000851
16	4000	>80	2632	165	67	1121	78	50	280	561	-	1121x55	661000850	661000852
48	3000	>80	7584	158	67	2241	78	50	840	561	-	2241x55	661000861	661000863
48	4000	>80	7920	165	67	2241	78	50	840	561	-	2241x55	661000862	661000864
48	3000	>80	7584	158	67	2801	78	50	840	1121	-	2801x55	661000865	661000867
48	4000	>80	7920	165	67	2801	78	50	840	1121	-	2801x55	661000866	661000868
Modulo Luce+Cieco+Luce+Cieco+Luce / Light+Blind+Light+Blind+Light Module														
24	3000	>80	3792	158	67	1401	78	50	280	280	280	1401x55	661000853	661000855
24	4000	>80	3960	165	67	1401	78	50	280	280	280	1401x55	661000854	661000856
32	3000	>80	5056	158	67	1681	78	50	280	280	560	1681x55	661000857	661000859
32	4000	>80	5280	165	67	1681	78	50	280	280	560	1681x55	661000858	661000860
Angolo 90° / 90° corner														
32	3000	>80	5056	158	67	553	78	50	-	-	-	620x620x55	661000869	661000871
32	4000	>80	5280	165	67	553	78	50	-	-	-	620x620x55	661000870	661000872
Angolo 120° / 120° corner														
32	3000	>80	5056	158	50	556	78	50	-	-	-	595x556x55	661000873	661000875
32	4000	>80	5280	165	50	556	78	50	-	-	-	595x556x55	661000874	661000876

I) Il flusso effettivo potrebbe avere una tolleranza del $\pm 10\%$. / The effective flux could have a tolerance of $\pm 10\%$.

II) Le dimensioni fanno riferimento al solo modulo, escluse le testate di inizio e fine linea (+10mm cad.) / Dimensions refer to the module without the two end caps (+10mm each).

III) Dimensioni complete a pag. 35 / Full dimension on page 35

OFC80

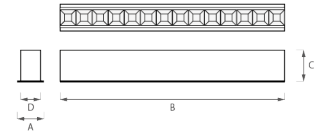
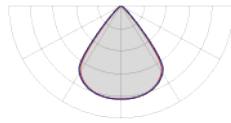

Potenza Power [W]	Temp. colore Colour Temp. [K]	IRC CRI	Flusso lum. Lum. flux [lm]	Eff. lum. Lum. effic. [lm / W]	Dimensioni / Dimensions [mm]								Cod. / Code LED	Cod. / Code LED DALI
					A	B	C	D	E	F	G			
Lineare / Linear														
8	3000	>80	1264	158	67	281	78	50	-	-	-	281x55	661001067	661001070
8	4000	>80	1316	165	67	281	78	50	-	-	-	281x55	661001073	661001076
16	3000	>80	2528	158	67	561	78	50	-	-	-	561x55	661001079	661001082
16	4000	>80	2632	165	67	561	78	50	-	-	-	561x55	661001085	661001088
32	3000	>80	5056	158	67	1121	78	50	-	-	-	1121x55	661001103	661001106
32	4000	>80	5280	165	67	1121	78	50	-	-	-	1121x55	661001109	661001112
48	3000	>80	7584	158	67	1681	78	50	-	-	-	1681x55	661001127	661001130
48	4000	>80	7920	165	67	1681	78	50	-	-	-	1681x55	661001133	661001136
65	3000	>80	10270	158	67	2241	78	50	-	-	-	2241x55	661001139	661001142
65	4000	>80	10725	165	67	2241	78	50	-	-	-	2241x55	661001145	661001148
81	3000	>80	12798	158	67	2801	78	50	-	-	-	2801x55	661001151	661001154
81	4000	>80	13365	165	67	2801	78	50	-	-	-	2801x55	661001157	661001160
Modulo Luce+Cieco / Light+Infill Module														
8	3000	>80	1264	158	67	561	78	50	280	281	-	561x55	661001163	661001166
8	4000	>80	1320	165	67	561	78	50	280	281	-	561x55	661001169	661001172
Modulo Luce+Cieco+Luce / Light+Infill+Light Module														
16	3000	>80	2528	158	67	841	78	50	280	281	-	841x55	661001175	661001178
16	4000	>80	2632	165	67	841	78	50	280	281	-	841x55	661001181	661001184
16	3000	>80	2528	158	67	1121	78	50	280	561	-	1121x55	661001187	661001190
16	4000	>80	2632	165	67	1121	78	50	280	561	-	1121x55	661001193	661001196
48	3000	>80	7584	158	67	2241	78	50	840	561	-	2241x55	661001223	661001226
48	4000	>80	7920	165	67	2241	78	50	840	561	-	2241x55	661001229	661001232
48	3000	>80	7584	158	67	2801	78	50	840	1121	-	2801x55	661001235	661001238
48	4000	>80	7920	165	67	2801	78	50	840	1121	-	2801x55	661001241	661001244
Modulo Luce+Cieco+Luce+Cieco+Luce / Light+Blind+Light+Blind+Light Module														
24	3000	>80	3792	158	67	1401	78	50	280	280	280	1401x55	661001199	661001202
24	4000	>80	3960	165	67	1401	78	50	280	280	280	1401x55	661001205	661001208
32	3000	>80	5056	158	67	1681	78	50	280	280	560	1681x55	661001211	661001214
32	4000	>80	5280	165	67	1681	78	50	280	280	560	1681x55	661001217	661001220
Angolo 90° / 90° corner														
32	3000	>80	5056	158	67	553	78	50	-	-	-	620x620x55	661001247	661001250
32	4000	>80	5280	165	67	553	78	50	-	-	-	620x620x55	661001253	661001256
Angolo 120° / 120° corner														
32	3000	>80	5056	158	50	556	78	50	-	-	-	595x556x55	661001259	661001262
32	4000	>80	5280	165	50	556	78	50	-	-	-	595x556x55	661001265	661001268

I) Il flusso effettivo potrebbe avere una tolleranza del ±10%. / The effective flux could have a tolerance of ±10%

II) Le dimensioni fanno riferimento al solo modulo, escluse le testate di inizio e fine linea (+10mm cad.) / Dimensions refer to the module without the two end caps (+10mm each).

III) Dimensioni complete a pag. 35 / Full dimension on page 35

PMO

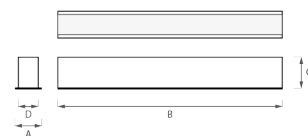
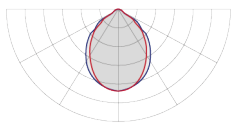

Potenza Power [W]	Temp. colore Colour Temp. [K]	IRC CRI	Flusso lum. Lum. flux [lm]	Efficienza lum. Lum. effic. [lm / W]	Dimensioni / Dimensions [mm]					Cod. / Code LED	Cod. / Code LED DALI
					A	B	C	D			
Lineare / Linear											
13	3000	>80	1092	84	67	561	78	50	561x55	661000700	661000701
13	4000	>80	1170	90	67	561	78	50	561x55	661000702	661000703
26	3000	>80	2184	84	67	1121	78	50	1121x55	661000704	661000705
26	4000	>80	2340	90	67	1121	78	50	1121x55	661000706	661000707
39	3000	>80	3276	84	67	1681	78	50	1681x55	661000708	661000709
39	4000	>80	3510	90	67	1681	78	50	1681x55	661000710	661000711
52	3000	>80	4368	84	67	2241	78	50	2241x55	661000712	661000713
52	4000	>80	4680	90	67	2241	78	50	2241x55	661000714	661000715
65	3000	>80	5460	84	67	2801	78	50	2801x55	661000716	661000717
65	4000	>80	5850	90	67	2801	78	50	2801x55	661000718	661000719
Angolo 90° / 90° corner											
26	3000	>80	2184	84	67	600	78	50	592x542x55	661000789	661000791
26	4000	>80	2340	90	67	600	78	50	592x542x55	661000790	661000792
Angolo parete-soffitto 90° / 90° wall-ceiling corner											
26	3000	>80	2184	84	67	620	78	50	542x542x55	661000793	661000795
26	4000	>80	2340	90	67	620	78	50	542x542x55	661000794	661000796
Angolo 120° / 120° corner											
26	3000	>80	2184	84	67	585	78	50	582x552x55	661000797	661000799
26	4000	>80	2340	90	67	585	78	50	582x552x55	661000798	661000800
Giunto Y / Y joint											
39	3000	>80	3276	84	67	545	78	50	552x55	661000801	661000803
39	4000	>80	3510	90	67	545	78	50	552x55	661000802	661000804
Giunto X / X joint											
52	3000	>80	4368	84	67	535	78	50	545x55	661000805	661000807
52	4000	>80	4680	90	67	535	78	50	545x55	661000806	661000808

I) Il flusso effettivo potrebbe avere una tolleranza del $\pm 10\%$. / The effective flux could have a tolerance of $\pm 10\%$.

II) Le dimensioni fanno riferimento al solo modulo, escluse le testate di inizio e fine linea (+10mm cad.) / Dimensions refer to the module without the two end caps (+10mm each).

III) Dimensioni complete a pag. 35 / Full dimension on page 35

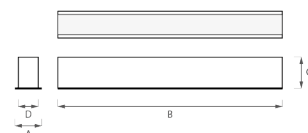
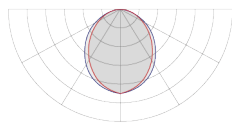

PST



Potenza Power [W]	Temp. colore Colour Temp. [K]	IRC CRI	⁽ⁱ⁾ Flusso lum. Lum. flux [lm] ⁽ⁱⁱ⁾	Efficienza lum. Lum. effic. [lm / W]	⁽ⁱⁱⁱ⁾ Dimensioni / Dimensions [mm]					Cod. / Code LED	Cod. / Code LED DALI
					A	B	C	D			
■ Lineare / Linear											
13	3000	>80	1105	85	67	561	78	50	561x55	661000664	661000665
13	4000	>80	1183	91	67	561	78	50	561x55	661000666	661000667
26	3000	>80	2210	85	67	1121	78	50	1121x55	661000668	661000669
26	4000	>80	2366	91	67	1121	78	50	1121x55	661000670	661000671
39	3000	>80	3315	85	67	1681	78	50	1681x55	661000672	661000673
39	4000	>80	3549	91	67	1681	78	50	1681x55	661000674	661000675
52	3000	>80	4420	85	67	2241	78	50	2241x55	661000676	661000677
52	4000	>80	4732	91	67	2241	78	50	2241x55	661000678	661000679
65	3000	>80	5525	85	67	2801	78	50	2801x55	661000680	661000681
65	4000	>80	5915	91	67	2801	78	50	2801x55	661000682	661000683
■ Angolo 90° / 90° corner											
26	3000	>80	2210	85	67	600	78	50	592X542x55	661000765	661000767
26	4000	>80	2366	91	67	600	78	50	592X542x55	661000766	661000768
■ Angolo parete-soffitto 90° / 90° wall-ceiling corner											
26	3000	>80	2210	85	67	620	78	50	542X542X55	661000769	661000771
26	4000	>80	2366	91	67	620	78	50	542X542X55	661000770	661000772
■ Angolo 120° / 120° corner											
26	3000	>80	2210	85	67	585	78	50	582X552X55	661000773	661000775
26	4000	>80	2366	91	67	585	78	50	582X552X55	661000774	661000776
Y Giunto Y / Y joint											
39	3000	>80	3315	85	67	545	78	50	552X55	661000781	661000783
39	4000	>80	3549	91	67	545	78	50	552X55	661000782	661000784
X Giunto X / X joint											
52	3000	>80	4420	85	67	535	78	50	545X55	661000785	661000787
52	4000	>80	4732	91	67	535	78	50	545X55	661000786	661000788

I) Il flusso effettivo potrebbe avere una tolleranza del ±10%. / The effective flux could have a tolerance of ±10%.

II) Le dimensioni fanno riferimento al solo modulo, escluse le testate di inizio e fine linea (+10mm cad.)/Dimensions refer to the module without the two end caps (+10mm each).

III) Dimensioni complete a pag. 35 / Full dimension on page 35

Met

IP40

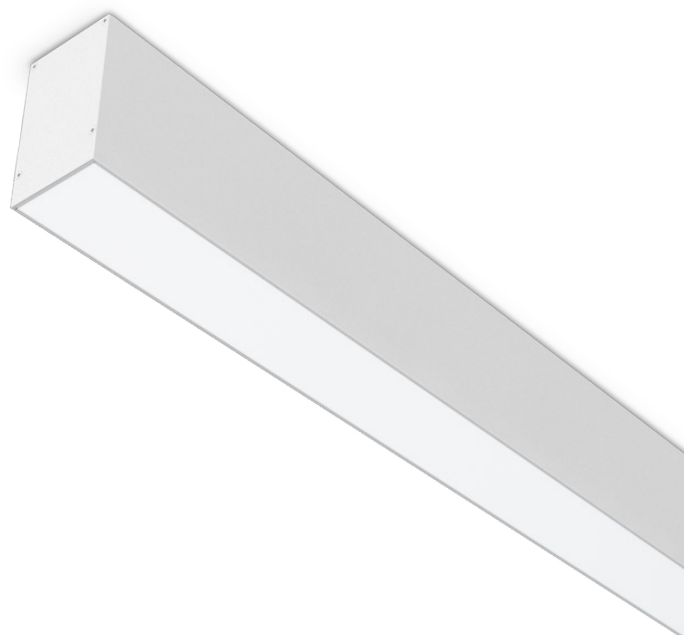

Caratteristiche tecniche

Technical Characteristics

Corpo	Profilo estruso in alluminio	Body	Extruded aluminium profile
Colore	<ul style="list-style-type: none"> ○ Bianco Dry (RAL 9003) <u>Su richiesta:</u> ● Altri colori 	Colour	<ul style="list-style-type: none"> ○ Dry white (RAL 9003) <u>On request:</u> ● Other colours available
Cablaggio	<ul style="list-style-type: none"> • LED ON/OFF con driver integrato • LED DALI con driver integrato • <u>Su richiesta:</u> • Circuito RGB • Kit di EMERGENZA (autonomia 1/3 h) 	Wiring	<ul style="list-style-type: none"> • LED ON/OFF with integrated driver • LED DALI with integrated driver • <u>On request:</u> • RGB circuit • EMERGENCY kit (1/3 h autonomy)
Gruppo ottico	• PST - policarbonato opale satinato	Optical group	• PST - glazed opal polycarbonate
Grado di protezione	IP 40	Protection degree	IP 40

Sorgenti LED

LED sources

IRC	<ul style="list-style-type: none"> • >80 <u>Su richiesta:</u> • >90 	CRI	<ul style="list-style-type: none"> • >80 <u>On request:</u> • >90
Temp. colore	<ul style="list-style-type: none"> • 3000 K • 4000 K <u>Su richiesta:</u> • TUNABLE WHITE 2700-6500 K • LED RGB 	Colour Temp.	<ul style="list-style-type: none"> • 3000 K • 4000 K <u>On request:</u> • TUNABLE WHITE 2700-6500 K • RGB LED

Gruppi ottici

Optical groups

PST

Diffusore in policarbonato opale satinato a finitura liscia, ideale per una distribuzione uniforme.

Diffuser in glazed opal polycarbonate with smooth finish, ideal for uniform distribution.

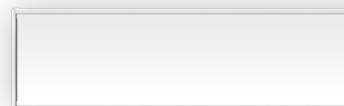
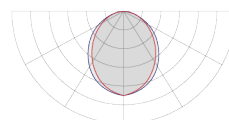

⁰⁰ **Accessori** (da ordinare separatamente)
Accessories (to be ordered separately)



TESTATE DI CHIUSURA
END CAPS

Cod. / Code TC671004
Alluminio verniciato di colore bianco Dry.
Completo di viti di fissaggio.
Dry white powder coated.
Fixing screws included.

2 pcs. kit



STAFFA D'UNIONE
UNION BRACKET

Cod. / Code KFS671000
Per l'installazione in linea continua, in acciaio zincato. Completo di viti di fissaggio.
Galvanized steel union bracket for continuous line installation. Fixing screws included.

Sospensione / Suspension



L= 2000 mm

CAVO DI SOSPENSIONE
SUSPENSION CABLE

Cod. / Code KS012
È necessario ordinare 2 pz per ogni lampada.
It is necessary to order 2 pcs. for each lamp.



L= 2000 mm
Ø 0,75 mmq

CAVO DI ALIMENTAZIONE TRASPARENTE
TRANSPARENT ELECTRIFIED FEEDING CABLE

Cod. / Code CVTXX075L020

- 3 poli (ON/OFF)/poles (ON/OFF)
- 5 poli (DALI e ON/OFF.+ emergenza)/ poles (DALI and ON/OFF + emergency)
- 7 poli (DALI + emergenza)/ poles (DALI + emergency)



ROSONE QUADRATO ELETTRIFICATO
ELECTRIFIED SQUARE CEILING ROSE

Cod. / Code KS02504E
Lamiera di acciaio verniciato di colore bianco dry,
2 fori per il passaggio del cavo di alimentazione
e di sospensione con morsetteria di connessione.
Powder coated in white dry colour sheet-steel,
2 holes for the passage of transparent power
cable and suspension cable, with terminal block.

PST

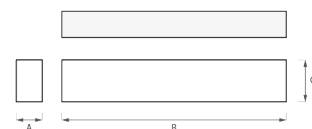
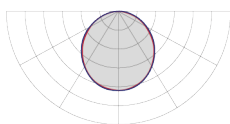

Potenza Power [W]	Temp. colore Colour Temp. [K]	IRC CRI	⁰⁰ Flusso lum. Lum. flux [lm]	Efficienza lum. Lum. effic. [lm / W]	⁰⁰⁰ Dimensioni / Dimensions [mm]			Cod. / Code LED	Cod. / Code LED DALI
					A	B	C		
■ modulo lineare / linear module									
13	3000	>80	1105	85	65	561	104	671000001	671000003
13	4000	>80	1183	91	65	561	104	671000002	671000004
26	3000	>80	2210	85	65	1121	104	671000005	671000006
26	4000	>80	2366	91	65	1121	104	671000009	671000010
39	3000	>80	3315	85	65	1681	104	671000013	671000014
39	4000	>80	3549	91	65	1681	104	671000017	671000018
52	3000	>80	4420	85	65	2241	104	671000021	671000022
52	4000	>80	4732	91	65	2241	104	671000025	671000026
65	3000	>80	5525	85	65	2801	104	671000029	671000030
65	4000	>80	5915	91	65	2801	104	671000033	671000034

I) L'apparecchio viene fornito accessorizzato di distanziali in ABS per l'installazione a plafone (H=10mm, colore bianco)/The device is equipped with ABS spacers for ceiling installation (H=10mm, white colour).

II) Il flusso effettivo potrebbe avere una tolleranza del ±10%./The effective flux could have a tolerance of ±10%

III) Le dimensioni fanno riferimento al solo modulo escluse le testate di inizio e fine linea (+2mm cad.)/Dimensions refer to the module without the two end caps (+2mm each).

Gap

Sistema **modulare** composto da un profilo in estruso di alluminio utilizzabile sia singolarmente che in **fila continua** per realizzare **tagli di luce** senza interruzioni.

*Modular system made of extruded aluminium profiles suitable to be used **individually** or to create **continuous row lighting systems**.*

Gap

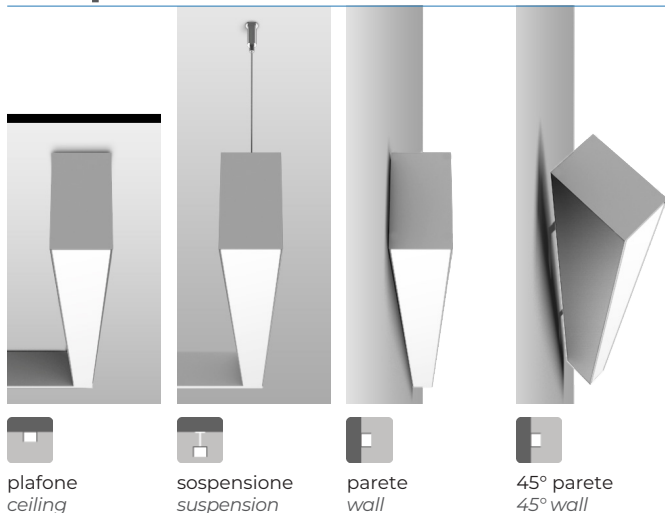

IP54

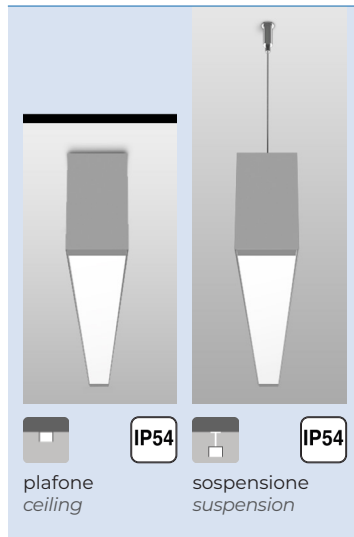

AS

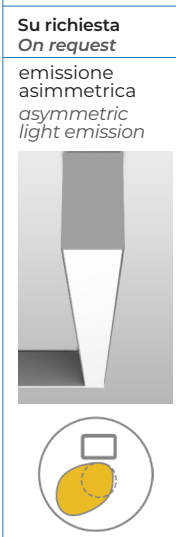

Gap Frame

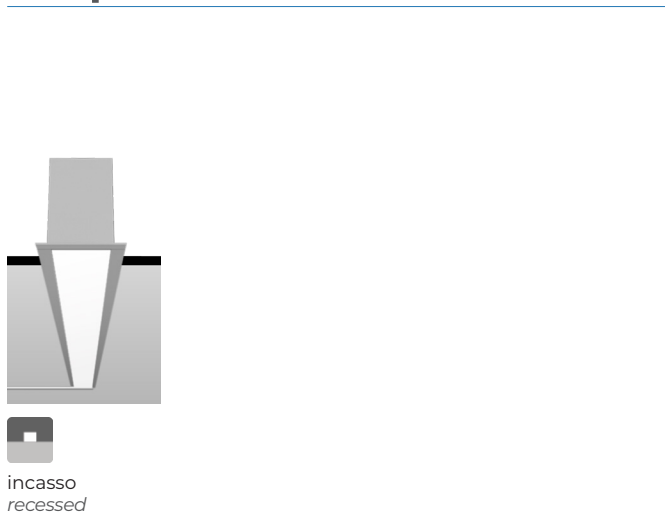

IP54

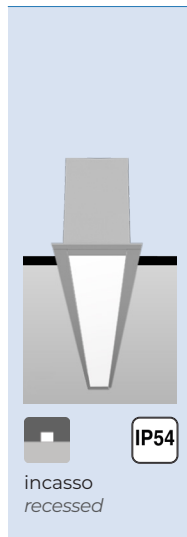

AS

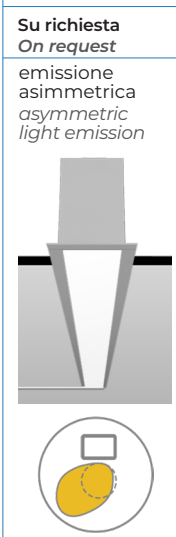

Giunti luminosi / Luminous joints

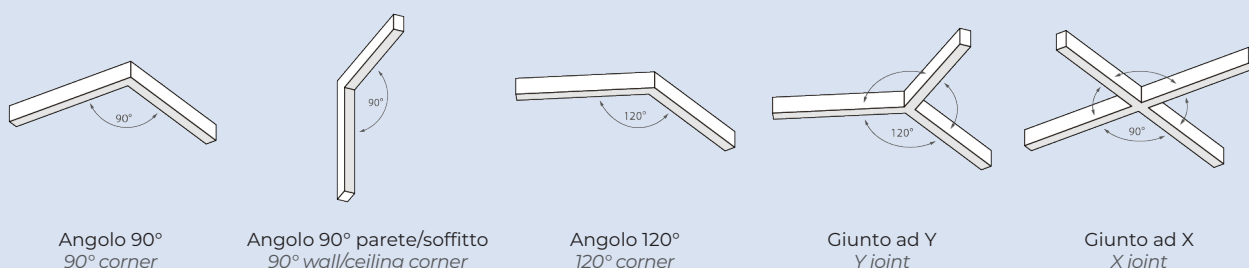

Gruppi ottici

Optical groups

PMO

Diffusore in policarbonato microprismatico anabbagliante. Valori di luminanza <math>< 3000 \text{ cd/m}^2</math> per angoli >math>65^\circ</math>. Film interno in policarbonato opale anabbagliante per una maggiore uniformità luminosa. Conforme ad essere installata in ambienti con uso di videotermini secondo la norma UNI EN 12464-1.

Diffuser made of anti-glare microprismatic polycarbonate. Luminance values <math>< 3000 \text{ cd/m}^2</math> for angles >math>65^\circ</math>. Internal anti-glare opal polycarbonate film for a better light uniformity. Suitable for installation in workplaces with the use of video terminals according to EN 12464-1 standard.

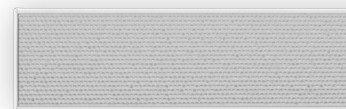
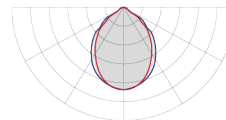

UGR
<math>< 19</math>

PST

Diffusore in policarbonato opale satinato a finitura liscia, ideale per una distribuzione uniforme.

Diffuser in glazed opal polycarbonate with smooth finish, ideal for uniform distribution.

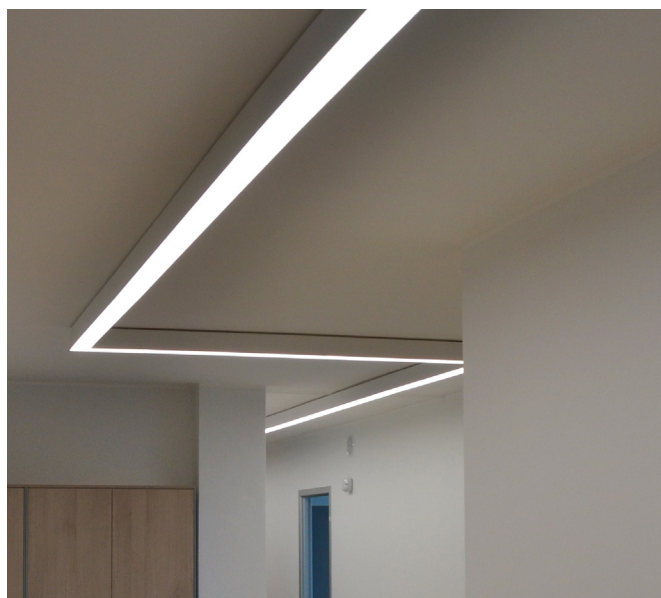
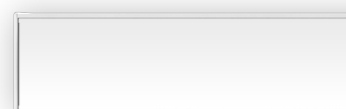
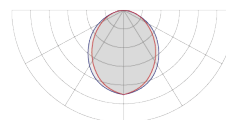

Gap

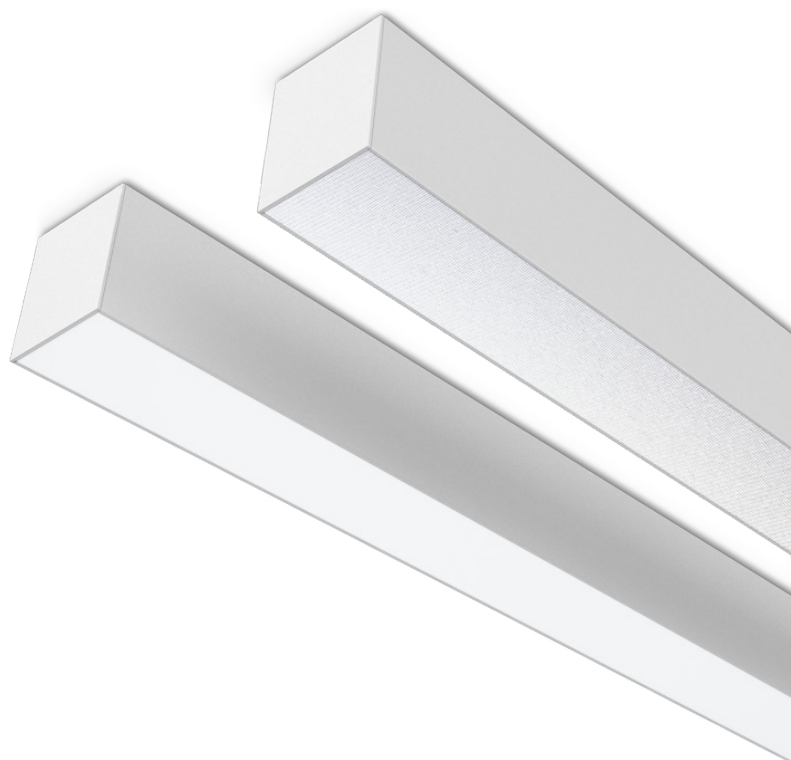

Caratteristiche tecniche

Technical Characteristics

Corpo	Profilo estruso in alluminio	Body	Extruded aluminium profile
Colore	<ul style="list-style-type: none"> ○ Bianco Dry <u>Su richiesta:</u> ● Altri colori 	Colour	<ul style="list-style-type: none"> ○ Dry white <u>On request:</u> ● Other colours available
Gruppo ottico	<ul style="list-style-type: none"> · PMO - policarbonato microprismatico (UGR<19) · PST - policarbonato opale satinato 	Optical group	<ul style="list-style-type: none"> · PMO - microprismatic polycarbonate (UGR<19) · PST - glazed opal polycarbonate
Cablaggio	<ul style="list-style-type: none"> · LED ON/OFF con driver integrato · LED DALI con driver integrato <u>Su richiesta:</u> · LED RGB · Kit di EMERGENZA (autonomia 1/3 h) 	Wiring	<ul style="list-style-type: none"> · LED ON/OFF with integrated driver · LED DALI with integrated driver <u>On request:</u> · RGB LED · EMERGENCY kit (1/3 h autonomy)
Grado di protezione	<ul style="list-style-type: none"> · IP 42 · IP 54⁽¹⁾ 	Protection degree	<ul style="list-style-type: none"> · IP 42 · IP 54⁽¹⁾

Sorgenti LED

LED sources

IRC	<ul style="list-style-type: none"> · >80 <u>Su richiesta:</u> · >90 	CRI	<ul style="list-style-type: none"> · >80 <u>On request:</u> · >90
Temp. colore	<ul style="list-style-type: none"> · 3000 K · 4000 K <u>Su richiesta:</u> · TUNABLE WHITE 2700-6500 K · LED RGB 	Colour Temp.	<ul style="list-style-type: none"> · 3000 K · 4000 K <u>On request:</u> · TUNABLE WHITE 2700-6500 K · RGB LED

1) L'apparecchio viene fornito in modulo lineare singolo, completo di testate, cavo in uscita (L=1000mm) e accessori di fissaggio a plafone o sospensione per garantire il grado di protezione dichiarato. / The lighting fitting is supplied complete with end caps, electrified output cable (L=1000mm) and fixing accessories for ceiling or suspended mounting to guarantee the declared protection degree.

Accessori (da ordinare separatamente)
Accessories (to be ordered separately)



TESTATE DI CHIUSURA
END CAPS
Cod. / Code TC760004
 Alluminio verniciato di colore bianco Dry.
Dry white powder coated.

2 pcs. kit



STAFFA D'UNIONE
UNION BRACKET
Cod. / Code KFS760000
 Per l'installazione in linea continua, in acciaio zincato. Completo di viti di fissaggio.
Galvanized steel union bracket for continuous line installation. Fixing screws included.

Incasso / Recessed



STAFFA PER INSTALLAZIONE A FILO
CARTONGESSO
PLASTERBOARD FLUSH MOUNTING
INSTALLATION BRACKET
Cod. / Code KFC660000
 Lamiera di acciaio zincato.
Galvanized steel sheet.

3 pcs. kit

Sospensione / Suspension



L= 2000 mm

CAVO DI SOSPENSIONE
SUSPENSION CABLE
Cod. / Code KS013
 È necessario ordinare 2 pz per ogni lampada.
It is necessary to order 2 pcs. for each lamp.



L= 2000 mm
 Ø 0,75 mmq

CAVO DI ALIMENTAZIONE TRASPARENTE
TRANSPARENT ELECTRIFIED FEEDING
CABLE
Cod. / Code CVTX075L020

- 3 poli (ON/OFF)/poles (ON/OFF)
- 5 poli (DALI e ON/OFF.+ emergenza)/ poles (DALI and ON/OFF + emergency)
- 7 poli (DALI + emergenza)/ poles (DALI + emergency)



ROSONE QUADRATO ELETTRIFICATO
ELECTRIFIED SQUARE CEILING ROSE
Cod. / Code KS02504E
 Alluminio verniciato di colore bianco Dry, 2 fori per il passaggio del cavo di alimentazione e di sospensione con morsettiera di connessione.
Powder coated in white dry colour, 2 holes for the passage of transparent power cable and suspension cable, with terminal block.

Parete / Wall



2 pcs. kit

STAFFA DI FISSAGGIO A 90°
90° WALL BRACKET
Cod. / Code KPR760004
 Lamiera di acciaio zincato, verniciata bianco Dry. Completo di viti di fissaggio.
Galvanized steel sheet, dry white powder coated. Fixing screws included.

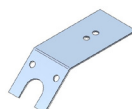

2 pcs. kit

STAFFA DI FISSAGGIO A 45°
45° WALL BRACKET
Cod. / Code KP4760004
 Lamiera di acciaio zincato, verniciata bianco Dry. Completo di viti di fissaggio.
Galvanized steel sheet, dry white powder coated. Fixing screws included.

II) L'apparecchio viene fornito accessorizzato di distanziali in ABS per l'installazione a plafone (H=10mm, colore bianco)/ The device is equipped with ABS spacers for ceiling installation (H=10mm, white colour).

IP42

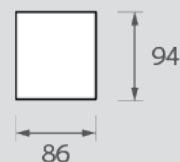

Lineare Linear

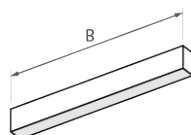

B
[mm]
561
1121
1681
2241
2801

Angolo parete/soffitto 90° 90° wall/ceiling corner

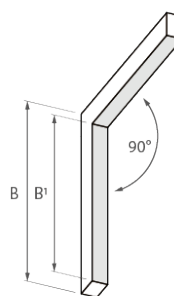

B	B'
[mm]	
650	556

Angolo 90° 90° corner

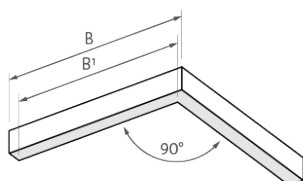

B	B'
[mm]	
620	534

Angolo 120° 120° corner

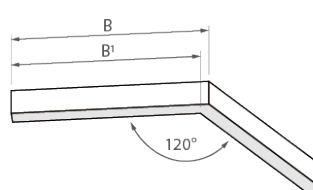

B	B'
[mm]	
595	545

Giunto ad Y Y joint

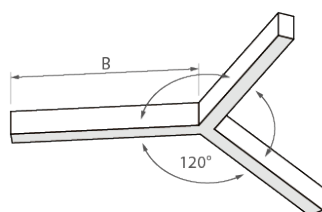

B
[mm]
545

Giunto ad X X joint

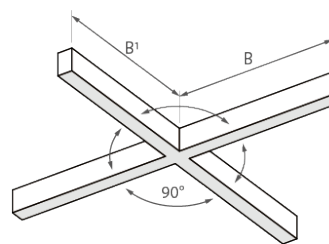

B
[mm]
530

Le dimensioni fanno riferimento al solo modulo, escluse le testate di inizio e fine linea (+3mm cad.).
 Aggiungere + 5mm alla somma totale della lunghezza di tutti i moduli posti in fila continua.
 Dimensions refer to the module without the two end caps (+3mm each).
 Add +5mm to the total length of the continuous row lighting system.

PMO

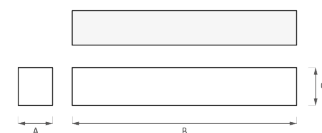
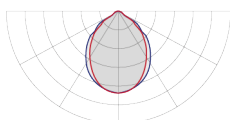

Potenza Power [W]	Temp. colore Colour Temp. [K]	IRC CRI	Flusso lum. Lum. flux [lm]	Efficienza lum. Lum. effic. [lm / W]	Dimensioni / Dimensions [mm]			Cod. / Code LED	Cod. / Code LED DALI
					A	B	C		
Lineare / Linear module									
13	3000	>80	1261	97	86	561	94	760100329	760100330
13	4000	>80	1365	105	86	561	94	760100333	760100334
26	3000	>80	2522	97	86	1121	94	760100345	760100346
26	4000	>80	2730	105	86	1121	94	760100349	760100350
39	3000	>80	3783	97	86	1681	94	760100361	760100362
39	4000	>80	4095	105	86	1681	94	760100365	760100366
52	3000	>80	5044	97	86	2241	94	760100377	760100378
52	4000	>80	5460	105	86	2241	94	760100381	760100382
65	3000	>80	6305	97	86	2801	94	760100393	760100394
65	4000	>80	6825	105	86	2801	94	760100397	760100398
Angolo 90° / 90° corner									
26	3000	>80	2522	97	86	620	94	760100552	760100554
26	4000	>80	2730	105	86	620	94	760100553	760100555
Angolo parete-soffitto 90° / 90° wall-ceiling corner									
26	3000	>80	2522	97	86	650	94	760100560	760100562
26	4000	>80	2730	105	86	650	94	760100561	760100563
Angolo 120° / 120° corner									
26	3000	>80	2522	97	86	595	94	760100564	760100566
26	4000	>80	2730	105	86	595	94	760100565	760100567
Giunto Y / Y joint									
39	3000	>80	3783	97	86	545	94	760100576	760100578
39	4000	>80	4095	105	86	545	94	760100577	760100579
Giunto X / X joint									
52	3000	>80	5044	97	86	530	94	760100580	760100582
52	4000	>80	5460	105	86	530	94	760100581	760100583

I) Il flusso effettivo potrebbe avere una tolleranza del ±10%. / The effective flux could have a tolerance of ±10%.

II) Le dimensioni fanno riferimento al solo modulo escluse le testate di inizio e fine linea (+3mm cad.) / Dimensions refer to the module without the two end caps (+3mm each).

III) Dimensioni complete a pag. 46 / Full dimension on page 46

PST

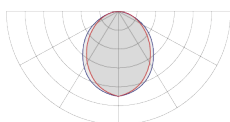

Potenza Power [W]	Temp. colore Colour Temp. [K]	IRC CRI	Flusso lum. Lum. flux [lm]	Efficienza lum. Lum. effic. [lm / W]	Dimensioni / Dimensions [mm]			Cod. / Code LED	Cod. / Code LED DALI
					A	B	C		
Lineare / Linear module									
13	3000	>80	1105	85	86	561	94	760100337	760100338
13	4000	>80	1183	91	86	561	94	760100341	760100342
26	3000	>80	2210	85	86	1121	94	760100353	760100354
26	4000	>80	2366	91	86	1121	94	760100357	760100358
39	3000	>80	3315	85	86	1681	94	760100369	760100370
39	4000	>80	3549	91	86	1681	94	760100373	760100374
52	3000	>80	4420	85	86	2241	94	760100385	760100386
52	4000	>80	4732	91	86	2241	94	760100389	760100390
65	3000	>80	5525	85	86	2801	94	760100401	760100402
65	4000	>80	5915	91	86	2801	94	760100405	760100406
Angolo 90° / 90° corner									
26	3000	>80	2210	85	86	620	94	760100548	760100550
26	4000	>80	2366	91	86	620	94	760100549	760100551
Angolo parete-soffitto 90° / 90° wall-ceiling corner									
26	3000	>80	2210	85	86	650	94	760100556	760100558
26	4000	>80	2366	91	86	650	94	760100557	760100559
Angolo 120° / 120° corner									
26	3000	>80	2210	85	86	595	94	760100568	760100570
26	4000	>80	2366	91	86	595	94	760100569	760100571
Giunto Y / Y joint									
39	3000	>80	3315	85	86	545	94	760100572	760100574
39	4000	>80	3549	91	86	545	94	760100573	760100575
Giunto X / X joint									
52	3000	>80	4420	85	86	527	94	760100584	760100586
52	4000	>80	4732	91	86	527	94	760100585	760100587

I) Il flusso effettivo potrebbe avere una tolleranza del $\pm 10\%$. / The effective flux could have a tolerance of $\pm 10\%$

II) Le dimensioni fanno riferimento al solo modulo escluse le testate di inizio e fine linea (+3mm cad.)/Dimensions refer to the module without the two end caps (+3mm each).

III) Dimensioni complete a pag. 46 / Full dimension on page 46



IP54

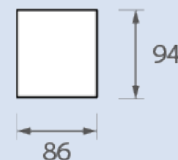

Plafone
Ceiling

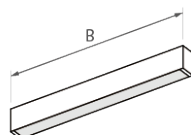

(1) B
[mm]
600
1160
1720
2280
2840

Sospensione
Suspension

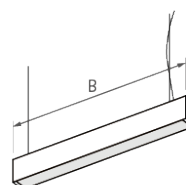

(1) B
[mm]
600
1160
1720
2280
2840

Accessori (da ordinare separatamente)
Accessories (to be ordered separately)

Sospensione / Suspension



ROSONE QUADRATO ELETRIFICATO
ELECTRIFIED SQUARE CEILING ROSE
Cod. / Code **KS02504E**

Lamiera di acciaio verniciato di colore bianco dry, 2 fori per il passaggio del cavo di alimentazione e di sospensione con morsettiera di connessione.
Powder coated in white dry colour sheet-steel, 2 holes for the passage of transparent power cable and suspension cable, with terminal block.

L'apparecchio viene fornito in modulo lineare singolo, completo di testate, cavi di sospensione e cavo di alimentazione trasparente di lunghezza standard (L=2000mm) e accessori di fissaggio a plafone o sospensione per garantire il grado di protezione dichiarato. / *The lighting fitting is supplied complete with end caps, suspension cable and transparent electrified cable are supplied in standard length (L=2000mm) and fixing accessories for ceiling or suspended mounting to guarantee the declared protection degree.*

PMO

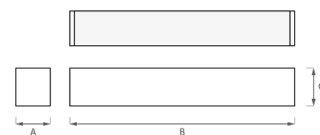
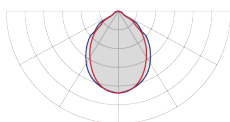

Potenza Power [W]	Temp. colore Colour Temp. [K]	IRC CRI	Flusso lum. Lum. flux [lm]	Efficienza lum. Lum. effic. [lm / W]	Dimensioni / Dimensions [mm]			Cod. / Code LED	Cod. / Code LED DALI
					A	B	C		
Lineare / Linear module									
13	3000	>80	1261	97	86	600	97	431000025	431000027
13	4000	>80	1365	105	86	600	97	431000029	431000031
26	3000	>80	2522	97	86	1160	97	431000041	431000043
26	4000	>80	2730	105	86	1160	97	431000045	431000047
39	3000	>80	3783	97	86	1720	97	431000057	431000059
39	4000	>80	4095	105	86	1720	97	431000061	431000063
52	3000	>80	5044	97	86	2280	97	431000073	431000075
52	4000	>80	5460	105	86	2280	97	431000077	431000079
65	3000	>80	6305	97	86	2840	97	431000089	431000091
65	4000	>80	6825	105	86	2840	97	431000093	431000095

PMO

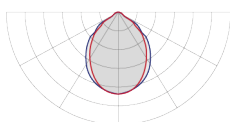

Potenza Power [W]	Temp. colore Colour Temp. [K]	IRC CRI	Flusso lum. Lum. flux [lm]	Efficienza lum. Lum. effic. [lm / W]	Dimensioni / Dimensions [mm]			Cod. / Code LED	Cod. / Code LED DALI
					A	B	C		
Lineare / Linear module									
13	3000	>80	1261	97	86	600	97	431000033	431000035
13	4000	>80	1365	105	86	600	97	431000037	431000039
26	3000	>80	2522	97	86	1160	97	431000049	431000051
26	4000	>80	2730	105	86	1160	97	431000053	431000055
39	3000	>80	3783	97	86	1720	97	431000065	431000067
39	4000	>80	4095	105	86	1720	97	431000069	431000071
52	3000	>80	5044	97	86	2280	97	431000081	431000083
52	4000	>80	5460	105	86	2280	97	431000085	431000087
65	3000	>80	6305	97	86	2840	97	431000097	431000099
65	4000	>80	6825	105	86	2840	97	431000101	431000103

I) Il flusso effettivo potrebbe avere una tolleranza del $\pm 10\%$. / The effective flux could have a tolerance of $\pm 10\%$.

II) L'apparecchio viene fornito in modulo lineare singolo, completo di testate, cavi di sospensione e cavo di alimentazione trasparente di lunghezza standard (L=2000mm) e accessori di fissaggio a plafone o sospensione per garantire il grado di protezione dichiarato. / The lighting fitting is supplied complete with end caps, suspension cable and transparent electrified cable are supplied in standard length (L=2000mm) and fixing accessories for ceiling or suspended mounting to guarantee the declared protection degree.

PST

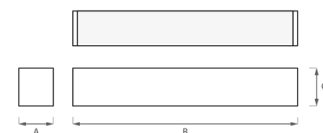
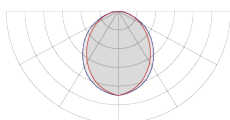

Potenza Power [W]	Temp. colore Colour Temp. [K]	IRC CRI	Flusso lum. Lum. flux [lm]	Efficienza lum. Lum. effic. [lm / W]	Dimensioni / Dimensions [mm]			Cod. / Code LED	Cod. / Code LED DALI
					A	B	C		
Lineare / Linear module									
13	3000	>80	1105	85	86	600	97	431000024	431000026
13	4000	>80	1183	91	86	600	97	431000028	431000030
26	3000	>80	2210	85	86	1160	97	431000040	431000042
26	4000	>80	2366	91	86	1160	97	431000044	431000046
39	3000	>80	3315	85	86	1720	97	431000056	431000058
39	4000	>80	3549	91	86	1720	97	431000060	431000062
52	3000	>80	4420	85	86	2280	97	431000072	431000074
52	4000	>80	4732	91	86	2280	97	431000076	431000078
65	3000	>80	5525	85	86	2840	97	431000088	431000090
65	4000	>80	5915	91	86	2840	97	431000092	431000094

PST

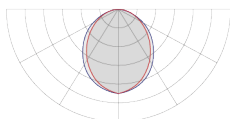

Potenza Power [W]	Temp. colore Colour Temp. [K]	IRC CRI	Flusso lum. Lum. flux [lm]	Efficienza lum. Lum. effic. [lm / W]	Dimensioni / Dimensions [mm]			Cod. / Code LED	Cod. / Code LED DALI
					A	B	C		
Lineare / Linear module									
13	3000	>80	1105	85	86	600	97	431000032	431000034
13	4000	>80	1183	91	86	600	97	431000036	431000038
26	3000	>80	2210	85	86	1160	97	431000048	431000050
26	4000	>80	2366	91	86	1160	97	431000052	431000054
39	3000	>80	3315	85	86	1720	97	431000064	431000066
39	4000	>80	3549	91	86	1720	97	431000068	431000070
52	3000	>80	4420	85	86	2280	97	431000080	431000082
52	4000	>80	4732	91	86	2280	97	431000084	431000086
65	3000	>80	5525	85	86	2840	97	431000096	431000098
65	4000	>80	5915	91	86	2840	97	431000100	431000102

I) Il flusso effettivo potrebbe avere una tolleranza del $\pm 10\%$. / The effective flux could have a tolerance of $\pm 10\%$.

II) L'apparecchio viene fornito in modulo lineare singolo, completo di testate, cavi di sospensione e cavo di alimentazione trasparente di lunghezza standard (L=2000mm) e accessori di fissaggio a plafone o sospensione per garantire il grado di protezione dichiarato. / The lighting fitting is supplied complete with end caps, suspension cable and transparent electrified cable are supplied in standard length (L=2000mm) and fixing accessories for ceiling or suspended mounting to guarantee the declared protection degree.

Gap Frame

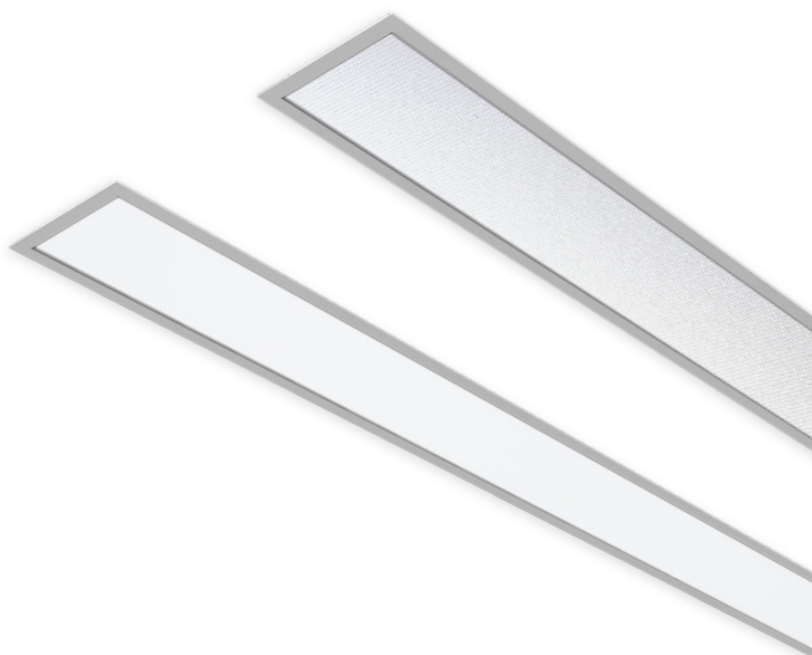

Caratteristiche tecniche

Technical Characteristics

Corpo	Profilo estruso in alluminio	Body	Extruded aluminium profile
Colore	<ul style="list-style-type: none"> ○ Bianco Dry (RAL 9003) Su richiesta: <ul style="list-style-type: none"> ● Altri colori 	Colour	<ul style="list-style-type: none"> ○ Dry white (RAL 9003) On request: <ul style="list-style-type: none"> ● Other colours available
Gruppo ottico	<ul style="list-style-type: none"> · PMO - policarbonato microprismatico (UGR<19) · PST - policarbonato opale satinato 	Optical group	<ul style="list-style-type: none"> · PMO - microprismatic polycarbonate (UGR<19) · PST - glazed opal polycarbonate
Cablaggio	<ul style="list-style-type: none"> · LED ON/OFF con driver integrato · LED DALI con driver integrato Su richiesta: <ul style="list-style-type: none"> · LED RGB · Kit di EMERGENZA (autonomia 1/3 h) 	Wiring	<ul style="list-style-type: none"> · LED ON/OFF with integrated driver · LED DALI with integrated driver On request: <ul style="list-style-type: none"> · RGB LED · EMERGENCY kit (1/3 h autonomy)
Grado di protezione	<ul style="list-style-type: none"> · IP 42 · IP 54⁽¹⁾ 	Protection degree	<ul style="list-style-type: none"> · IP 42 · IP 54⁽¹⁾

Sorgenti LED

LED sources

IRC	<ul style="list-style-type: none"> · >80 Su richiesta: <ul style="list-style-type: none"> · >90 	CRI	<ul style="list-style-type: none"> · >80 On request: <ul style="list-style-type: none"> · >90
Temp. colore	<ul style="list-style-type: none"> · 3000 K · 4000 K Su richiesta: <ul style="list-style-type: none"> · TUNABLE WHITE 2700-6500 K · LED RGB 	Colour Temp.	<ul style="list-style-type: none"> · 3000 K · 4000 K On request: <ul style="list-style-type: none"> · TUNABLE WHITE 2700-6500 K · RGB LED

1) L'apparecchio viene fornito in modulo lineare singolo, completo di testate, cavi di sospensione e cavo di alimentazione trasparente di lunghezza standard (L=2000mm) e accessori di fissaggio a plafone o sospensione per garantire il grado di protezione dichiarato. / The lighting fitting is supplied complete with end caps, suspension cable and transparent electrified cable of standard length (L=2000mm) and fixing accessories for ceiling or suspended mounting to guarantee the declared protection degree.

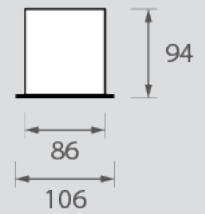

IP42

Lineare Linear

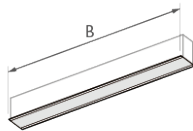

B	[mm]
561	561x92
1121	1121x92
1681	1681x92
2241	2241x92
2801	2801x92

Angolo parete/soffitto 90° 90° wall/ceiling corner

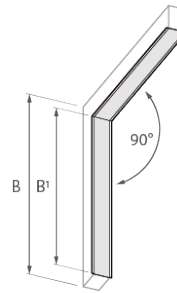

B	B'	[mm]
650	555	650x650x92

Angolo 90° 90° corner

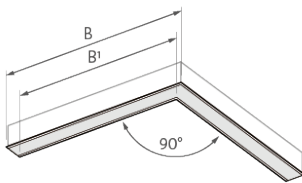

B	B'	[mm]
630	523	622x534x92

Angolo 120° 120° corner

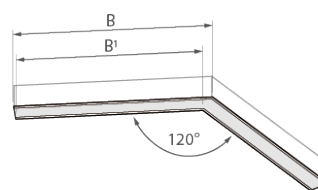

B	B'	[mm]
600	539	597x545x92

Giunto ad Y Y joint

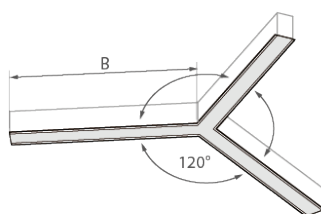

B	[mm]
540	547x92

Giunto ad X X joint

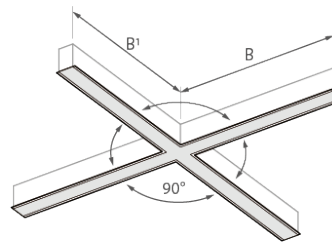

B	[mm]
515	525x92

Accessori (da ordinare separatamente) Accessories (to be ordered separately)



2 pcs. kit

TESTATE DI CHIUSURA

END CAPS

Cod. / Code TC760204

Lamiera d'acciaio verniciata di colore bianco dry.

Completo di viti di fissaggio.

Dry white powder coated sheet-steel.

Fixing screws included.



2 pcs. kit

STAFFA D'UNIONE PER

UNION BRACKET

Cod. / Code KFS760200

Per l'installazione in linea continua, in acciaio zincato.

Galvanized steel union bracket for continuous line installation.

Le dimensioni fanno riferimento al solo modulo, escluse le testate di inizio e fine linea (+10mm cad.).

Aggiungere + 5mm alla somma totale della lunghezza di tutti i moduli posti in fila continua. /

Dimensions refer to the module without the two end caps (+10mm each).

Add +5mm to the total length of the continuous row lighting system

PMO

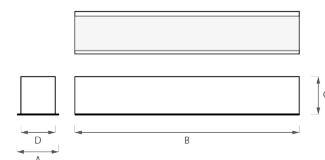
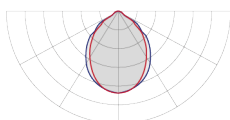

Potenza Power [W]	Temp. colore Colour Temp. [K]	IRC CRI	Flusso lum. Lum. flux [lm]	Efficienza lum. Lum. effic. [lm / W]	Dimensioni / Dimensions [mm]					Cod. / Code LED	Cod. / Code LED DALI
					A	B	C	D			
■ Lineare / Linear											
13	3000	>80	1261	97	106	561	95	86	561x92	760300205	760300206
13	4000	>80	1365	105	106	561	95	86	561x92	760300209	760300210
26	3000	>80	2522	97	106	1121	95	86	1121x92	760300221	760300222
26	4000	>80	2730	105	106	1121	95	86	1121x92	760300225	760300226
39	3000	>80	3783	97	106	1681	95	86	1681x92	760300237	760300238
39	4000	>80	4095	105	106	1681	95	86	1681x92	760300241	760300242
52	3000	>80	5044	97	106	2241	95	86	2241x92	760300253	760300254
52	4000	>80	5460	105	106	2241	95	86	2241x92	760300257	760300258
65	3000	>80	6305	97	106	2801	95	86	2801x92	760300269	760300270
65	4000	>80	6825	105	106	2801	95	86	2801x92	760300273	760300274
■ Angolo 90° / 90° corner											
26	3000	>80	2522	97	106	630	95	86	622x534x92	760300319	760300321
26	4000	>80	2730	105	106	630	95	86	622x534x92	760300320	760300322
■ Angolo parete-soffitto 90° / 90° wall-ceiling corner											
26	3000	>80	2522	97	106	650	95	86	650x650x92	760300355	760300357
26	4000	>80	2730	105	106	650	95	86	650x650x92	760300356	760300358
■ Angolo 120° / 120° corner											
26	3000	>80	2522	97	106	600	95	86	597x545x92	760300367	760300369
26	4000	>80	2730	105	106	600	95	86	597x545x92	760300368	760300370
Y Giunto Y / Y joint											
39	3000	>80	3315	3783	106	540	95	86	547x92	760300371	760300373
39	4000	>80	3549	4095	106	540	95	86	547x92	760300372	760300374
X Giunto X / X joint											
52	3000	>80	4420	5044	106	515	95	86	525x55	760300383	760300385
52	4000	>80	4732	5460	106	515	95	86	525x55	760300384	760300386

I) Il flusso effettivo potrebbe avere una tolleranza del $\pm 10\%$. / The effective flux could have a tolerance of $\pm 10\%$.

II) Le dimensioni fanno riferimento al solo modulo, escluse le testate di inizio e fine linea (+10mm cad.) / Dimensions refer to the module without the two end caps (+10mm each).

III) Dimensioni complete a pag. 53 / Full dimension on page 53

PST

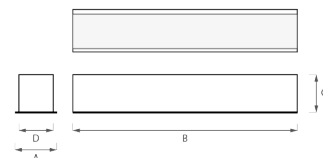
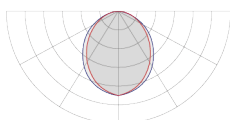

Potenza Power [W]	Temp. colore Colour Temp. [K]	IRC CRI	Flusso lum. Lum. flux [lm]	Efficienza lum. Lum. effic. [lm / W]	Dimensioni / Dimensions [mm]					Cod. / Code LED	Cod. / Code LED DALI
					A	B	C	D			
Lineare / Linear											
13	3000	>80	1105	85	106	561	95	86	561x92	760300213	760300214
13	4000	>80	1183	91	106	561	95	86	561x92	760300217	760300218
26	3000	>80	2210	85	106	1121	95	86	1121x92	760300229	760300230
26	4000	>80	2366	91	106	1121	95	86	1121x92	760300233	760300234
39	3000	>80	3315	85	106	1681	95	86	1681x92	760300245	760300246
39	4000	>80	3549	91	106	1681	95	86	1681x92	760300249	760300250
52	3000	>80	4420	85	106	2241	95	86	2241x92	760300261	760300262
52	4000	>80	4732	91	106	2241	95	86	2241x92	760300265	760300266
65	3000	>80	5525	85	106	2801	95	86	2801x92	760300277	760300278
65	4000	>80	5915	91	106	2801	95	86	2801x92	760300281	760300282
Angolo 90° / 90° corner											
26	3000	>80	2210	85	106	630	95	86	622x534x92	760300315	760300317
26	4000	>80	2366	91	106	630	95	86	622x534x92	760300316	760300286
Angolo parete-soffitto 90° / 90° wall-ceiling corner											
26	3000	>80	2210	85	106	650	95	86	650x650x92	760300359	760300361
26	4000	>80	2366	91	106	650	95	86	650x650x92	760300360	760300362
Angolo 120° / 120° corner											
26	3000	>80	2210	85	106	600	95	86	597x545x92	760300363	760300365
26	4000	>80	2366	91	106	600	95	86	597x545x92	760300364	760300366
Giunto Y / Y joint											
39	3000	>80	3315	85	106	540	95	86	547x92	760300375	760300377
39	4000	>80	3549	91	106	540	95	86	547x92	760300376	760300378
Giunto X / X joint											
52	3000	>80	4420	85	106	515	95	86	525x55	760300379	760300381
52	4000	>80	4732	91	106	515	95	86	525x55	760300380	760300382

I) Il flusso effettivo potrebbe avere una tolleranza del ±10%. / The effective flux could have a tolerance of ±10%.

II) Le dimensioni fanno riferimento al solo modulo, escluse le testate di inizio e fine linea (+10mm cad.)/Dimensions refer to the module without the two end caps (+10mm each).

III) Dimensioni complete a pag. 53 / Full dimension on page 53



IP54

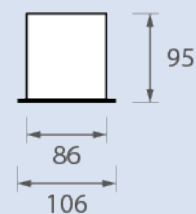
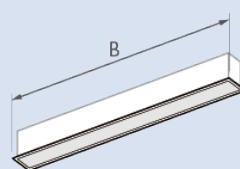

PMO

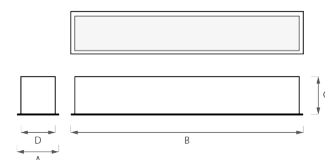
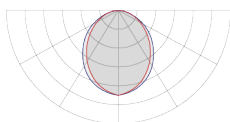

Potenza Power [W]	Temp. colore Colour Temp. [K]	IRC CRI	Flusso lum. Lum. flux [lm]	Efficienza lum. Lum. effic. [lm/W]	Dimensioni / Dimensions [mm]					Cod. / Code LED	Cod. / Code LED DALI
					A	B	C	D			
13	3000	>80	1261	97	106	620	95	86	602x92	431100002	431100004
13	4000	>80	1365	105	106	620	95	86	602x92	431100006	431100008
26	3000	>80	2522	97	106	1180	95	86	1172x92	431100010	431100012
26	4000	>80	2730	105	106	1180	95	86	1172x92	431100014	431100016
39	3000	>80	3783	97	106	1740	95	86	1722x92	431100018	431100020
39	4000	>80	4095	105	106	1740	95	86	1722x92	431100022	431100024
52	3000	>80	5044	97	106	2300	95	86	2282x92	431100026	431100028
52	4000	>80	5460	105	106	2300	95	86	2282x92	431100030	431100032
65	3000	>80	6305	97	106	2860	95	86	2842x92	431100034	431100036
65	4000	>80	6825	105	106	2860	95	86	2842x92	431100038	431100040

PST

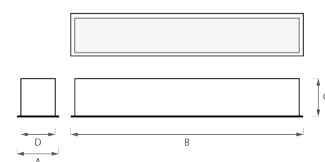
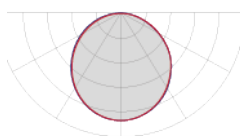

Potenza Power [W]	Temp. colore Colour Temp. [K]	IRC CRI	Flusso lum. Lum. flux [lm]	Efficienza lum. Lum. effic. [lm/W]	Dimensioni / Dimensions [mm]					Cod. / Code LED	Cod. / Code LED DALI
					A	B	C	D			
13	3000	>80	1105	85	106	620	95	86	602x92	431100001	431100003
13	4000	>80	1183	91	106	620	95	86	602x92	431100005	431100007
26	3000	>80	2210	85	106	1180	95	86	1172x92	431100009	431100011
26	4000	>80	2366	91	106	1180	95	86	1172x92	431100013	431100015
39	3000	>80	3315	85	106	1740	95	86	1722x92	431100017	431100019
39	4000	>80	3549	91	106	1740	95	86	1722x92	431100021	431100023
52	3000	>80	4420	85	106	2300	95	86	2282x92	431100025	431100027
52	4000	>80	4732	91	106	2300	95	86	2282x92	431100029	431100031
65	3000	>80	5525	85	106	2860	95	86	2842x92	431100033	431100035
65	4000	>80	5915	91	106	2860	95	86	2842x92	431100037	431100039

I) Il flusso effettivo potrebbe avere una tolleranza del $\pm 10\%$. / The effective flux could have a tolerance of $\pm 10\%$.

II) L'apparecchio viene fornito in modulo lineare singolo, completo di testate e cavo in uscita (L=1000mm) per garantire il grado di protezione dichiarato. / The lighting fitting is supplied complete with end caps and electrified output cable (L=1000mm) to guarantee the declared protection degree.



Link

IP40

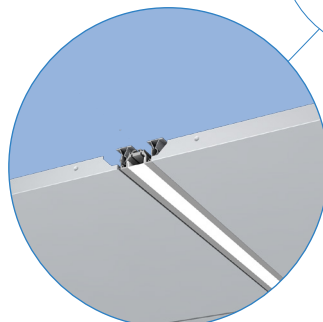

Struttura nascosta
Clip-in false ceiling

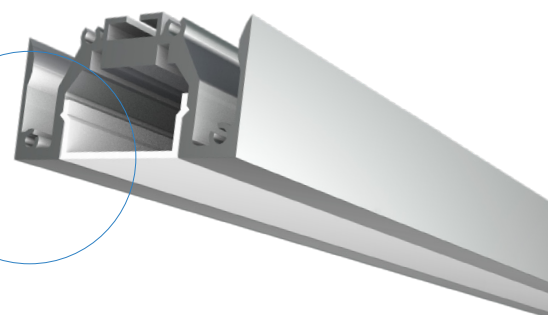

Caratteristiche tecniche

Technical Characteristics

Corpo	Profilo estruso in alluminio	Body	Extruded aluminium profile
Colore	<input type="radio"/> Bianco opaco (RAL 9003) <u>Su richiesta:</u> <input type="radio"/> Altri colori	Colour	<input type="radio"/> Matt white (RAL 9003) <u>On request:</u> <input type="radio"/> Other colours available
Gruppo ottico	<ul style="list-style-type: none"> MST - metacrilato opale satinato 	Optical group	<ul style="list-style-type: none"> MST - glazed opal methacrylate
Cablaggio	<ul style="list-style-type: none"> ¹⁾ LED ON/OFF con driver remoto <u>Su richiesta:</u> <ul style="list-style-type: none"> LED DALI LED RGB Kit di EMERGENZA (autonomia 1/3 h) 	Wiring	<ul style="list-style-type: none"> ¹⁾ LED ON/OFF with remote driver <u>On request:</u> <ul style="list-style-type: none"> LED DALI RGB LED EMERGENCY kit (1/3 h autonomy)
Grado di protezione	IP 40 <u>Su richiesta:</u> <ul style="list-style-type: none"> IP65 	Protection degree	IP 40 <u>On request:</u> <ul style="list-style-type: none"> IP65

Sorgenti LED

LED sources

IRC	<ul style="list-style-type: none"> >90 	CRI	<ul style="list-style-type: none"> >90
Temp. colore	<ul style="list-style-type: none"> 3000 K 4000 K <u>Su richiesta:</u> <ul style="list-style-type: none"> TUNABLE WHITE 2700-6500 K LED RGB 	Colour Temp.	<ul style="list-style-type: none"> 3000 K 4000 K <u>On request:</u> <ul style="list-style-type: none"> TUNABLE WHITE 2700-6500 K RGB LED

Gruppi ottici

Optical groups

MST

Diffusore in metacrilato opale satinato a finitura liscia, ideale per una distribuzione uniforme.

Diffuser in glazed opal methacrylate with smooth finish, ideal for uniform distribution.

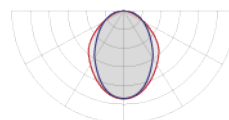

Tipologia di installazione

Type of installation

CONTROSOFFITTO CLIP-IN

Clip-in ceiling

Controsoffitto ispezionabile a pannelli modulari con struttura nascosta del tipo ENIGMA di Atena Spa. L'installazione degli apparecchi illuminanti avviene in totale integrazione con il controsoffitto.

Viene inoltre prevista una staffa antisismica per garantire una maggiore sicurezza.

Hook-down modular panels false ceiling with clip-in structure. The installation of lighting fittings occurs in a full integration with the false ceiling structure. An anti-seismic bracket is also provided to ensure greater safety.

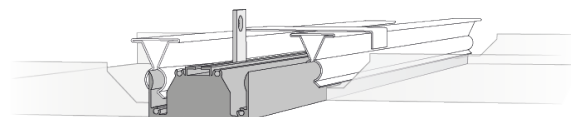

Moduli / Modules

Lineare singolo <i>Single linear</i>	Unione lineare <i>Linear joint</i>	Inizio-fine lineare <i>Linear start-end</i>	Angolo singolo <i>Single corner</i>	Angolo unione <i>Jointed corner</i>	Angolo inizio-fine dx <i>Right start-end corner</i>	Angolo inizio-fine sx <i>Left start-end corner</i>
Modulo completo di testate su ambo i lati	Modulo senza testate	Modulo completo di una sola testata	Modulo angolare a 90°, completo di testate su due lati	Modulo angolare a 90°, senza testate	Modulo angolare a 90°, completo di una testata su lato destro	Modulo angolare a 90°, completo di una testata su lato sinistro
<i>Module with beginning and ending caps included</i>	<i>Module without end caps included</i>	<i>Module with only one end cap included</i>	<i>90° corner module complete with beginning and ending caps included</i>	<i>90° joint corner module without end caps included</i>	<i>90° joint corner module complete with only one end cap (right side) included</i>	<i>90° joint corner module complete with only one end cap (left side) included</i>

Accessori (da ordinare separatamente)

Accessories (to be ordered separately)

Giunti / Joints



STAFFA D'UNIONE LINEARE
LINEAR UNION BRACKET
Cod. / Code **KFSLINK00**
Per l'installazione in linea continua, in acciaio zincato. Completo di viti di fissaggio.
Galvanized steel union bracket for continuous line installation. Fixing screws included.

STAFFA D'UNIONE 90°
90° UNION BRACKET
Cod. / Code **KFLLINK00**
Per l'installazione in fila continua ad angolo 90°. in acciaio zincato. Completo di viti di fissaggio.
Galvanized steel union bracket for continuous line installation. Fixing screws included.

Componenti disassemblati / Disassembled components



PROFILO LINK
LINK PROFILE
Cod. / Code **670100002**
Colore bianco opaco RAL 9003
Matt white RAL 9003 colour

L= 3000 mm

DIFFUSORE
DIFFUSER
Cod. / Code **DF67003000MST**
Diffusore in metacrilato opale satinato (MST)
Glazed opal methacrylate diffuser (MST)

L= 3000 mm

TESTATE DI CHIUSURA
END CAPS
Cod. / Code **TC670001**
Lamiera di acciaio verniciato di colore bianco opaco RAL 9003. Completo di viti di fissaggio.
Matt white RAL 9003 colour end caps sheet-steel. Fixing screws included

2 pcs.kit

ALIMENTATORI
DRIVERS
Dettagli tecnici a pag. 38
Technical details from page 38

ROLLE LED
STRIP LED
Dettagli tecnici a pag. 38
Technical details from page 38

Alimentatori per moduli disassemblati

Drivers for disassembled modules

		Potenza Power [W]	Tensione in ingresso Input Voltage. [V ; Hz]	Dimensioni Dimensions [mm]	Codice Code
IP20	ON/OFF	20	220-240 ; 50	148 x 45,8 x 22,5	711000013
		50	110-240 ; 50/60	172,2 x 63 x 30	711000015
		75	110-240 ; 50/60	193,2 x 63 x 30	711000016
		150	220-240 ; 50/60	180 x 65,5 x 31,2	711000042
	DALI	35	220-240 ; 50/60 220-240 ; 0	195 x 43 x 30,2	711000044
		60	220-240 ; 50/60 220-240 ; 0	225 x 43 x 30,2	711000045
		100	220-240 ; 50/60 220-240 ; 0	295 x 43 x 29,8	711000046
		150	220-240 ; 50/60 220-240 ; 0	325 x 43 x 29,8	711000047
		DMX	55	220-240 ; 50/60	147 x 75 x 39
		100	110-240 ; 50/60	207 x 76 x 35	711000011
IP67	ON/OFF	20	110-240 ; 50/60 220-240 ; 0	118 x 35 x 26	711000010
		60	110-240 ; 50/60 220-240 ; 0	162,5 x 42,5 x 32	711000018
		100	110-240 ; 50/60 220-240 ; 0	190 x 52 x 37	711000019
		150	110-240 ; 50/60	191 x 63 x 37,5	711000020

Rolle LED per moduli disassemblati

LED Rolls for disassembled modules

		Potenza Power [W / m]	Temp. colore Colour Temp. [K]	IRC CRI	Flusso lum. Lum. flux [lm]	Efficienza lum. Lum. effic. [lm / W]	Voltaggio Voltage [VDC]	Taglio Cut each [mm]	Larg. PSB PSB width [mm]	Codice Code	
IP20	STRIP 10W	10	120	3000	>90	835	84	24 VDC	50	8	710000042
		10	120	4000	>90	875	88	24 VDC	50	8	710000043
	STRIP 15W	15	120	3000	>90	1450	97	24 VDC	50	8	710000046
		15	120	4000	>90	1567	104	24 VDC	50	8	710000047
	STRIP 15W HP	15	84	3000	>90	2119	141	24 VDC	83,3	10	710000048
		15	84	4000	>90	2230	149	24 VDC	83,3	10	710000049
	STRIP 15W RGB	15	60	RGB	-	-	-	24 VDC	100	10	710000060
	STRIP 15W RGB+W	15	60	RGB+3000	>80	2075	138	24 VDC	100	10	710000062
		15	60	RGB+4000	>80	2125	142	24 VDC	100	10	710000063
	STRIP 25W	25	204	3000	>90	2355	94	24 VDC	29,4	8	710000052
		25	204	4000	>90	2525	101	24 VDC	29,4	8	710000053
	STRIP 25W HP	25	140	3000	>90	3618	145	24 VDC	50	10	710000056
		25	140	4000	>90	3808	152	24 VDC	50	10	710000057
	STRIP 1W	30	60	2500-6500	>80	2300	77	24 VDC	50	10	710000066

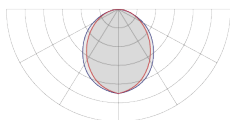
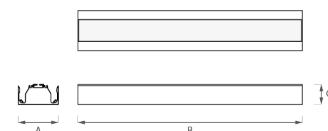

MST



Potenza Power [W]	Temp. colore Colour Temp. [K]	IRC CRI	Flusso lum. Lum. flux [lm]	Efficienza lum. Lum. effic. [lm / W]	Dimensioni / Dimensions [mm]			Cod. / Code LED		
					A	B	C	← [] →	— [] —	→ [] ←
Lineare / Linear module										
9	3000	>90	684	76	50	600	25	670000113	670000100	670000125
9	4000	>90	738	82	50	600	25	670000114	670000101	670000126
18	3000	>90	1368	76	50	1200	25	670000115	670000102	670000127
18	4000	>90	1476	82	50	1200	25	670000116	670000103	670000128
27	3000	>90	2052	76	50	1800	25	670000117	670000104	670000129
27	4000	>90	2214	82	50	1800	25	670000118	670000105	670000130
36	3000	>90	2736	76	50	2400	25	670000119	670000106	670000131
36	4000	>90	2952	82	50	2400	25	670000120	670000107	670000132
45	3000	>90	3420	76	50	3000	25	670000121	670000108	670000133
45	4000	>90	3690	82	50	3000	25	670000122	670000109	670000134
Angolo 90° / 90° corner										
18	3000	>90	1368	76	50	600	25	670000141	670000143	
18	4000	>90	1476	82	50	600	25	670000142	670000144	
Angolo 90° / 90° corner										
18	3000	>90	1368	76	50	600	25	670000145	670000147	
18	4000	>90	1476	82	50	600	25	670000146	670000148	



I) Il flusso effettivo potrebbe avere una tolleranza del ±10%. / The effective flux could have a tolerance of ±10%.
 II) Le dimensioni fanno riferimento al solo modulo, escluse le testate di inizio e fine linea (+2mm cad.). / Dimensions refer to the module without the two end caps (+2mm each).

Touch

Disponibile nella versione a luce **diretta**, **indiretta** e **diretta/indiretta**, con la possibilità di applicare un **sensore** di movimento e luminosità, TOUCH permette di creare file continue o forme rettangolari.

Available with **direct**, **indirect** and **direct/indirect** light emission, with the possibility to have a movement and luminance **sensor**, it is suitable for a single module or multiple modules installation.

Touch



Touch IND



Touch I/D



Sensore / Sensor

Le versioni di TOUCH LED con sensore permettono di avere un sistema di gestione della luce molto flessibile totalmente compatibile con lo standard DALI.

Il sistema è provvisto di 6 differenti modalità di funzionamento pre-programmate per le diverse esigenze di controllo della luce. Si compone di un'interfaccia DALI a 2 canali e da un sensore che integra e combina, in un unico dispositivo, le funzioni di un rilevatore di movimento, di un sensore a luce costante e di un ricevitore a infrarossi per l'utilizzo di un telecomando (opzionale).

TOUCH LED with sensor allows having a very flexible lighting control system, easy fully compatible with the DALI standard. This system has 6 pre-programmed operation modes for different lighting control applications.

It combines a DALI interface module with two channels and a sensor that integrates on one unique device a movement detector, a constant light photocell and a remote control receiver for the use of an optional remote control.

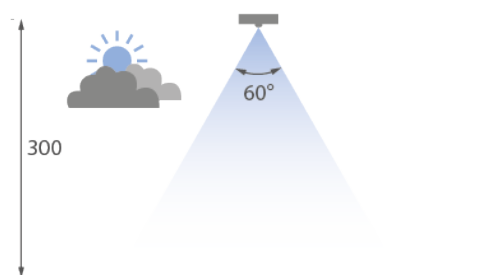
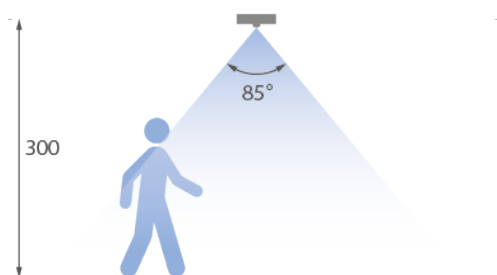

Moduli ciechi / Infill modules

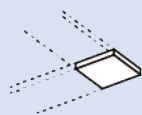

Giunto a 2 vie
2-way joint

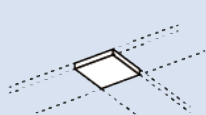

Giunto a 3 vie
3-way joint

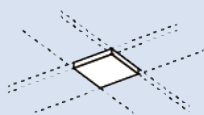

Giunto a 4 vie
4-way joint

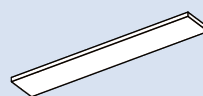

Modulo cieco lineare
Linear infill module

Gruppi ottici

Optical groups

PMO

Diffusore in policarbonato microprismatico anabbagliante. Valori di luminanza <math><3000\text{ cd/m}^2</math> per angoli >math>65^\circ</math>. Film interno in policarbonato opale anabbagliante per una maggiore uniformità luminosa. Conforme ad essere installata in ambienti con uso di videotermini secondo la norma UNI EN 12464-1.

Diffuser made of anti-glare microprismatic polycarbonate. Luminance values <math><3000\text{ cd/m}^2</math> for angles >math>65^\circ</math>. Internal anti-glare opal polycarbonate film for a better light uniformity. Suitable for installation in workplaces with the use of video terminals according to EN 12464-1 standard.

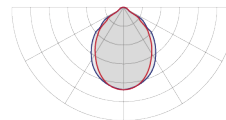

UGR <math><19</math>

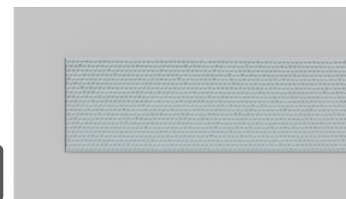

DLM

Ottica darklight in alluminio speculare ad emissione "batwing". Valori di luminanza <math><1000\text{ cd/m}^2</math> per angoli >math>65^\circ</math>. Film interno in policarbonato opale anabbagliante per una maggiore uniformità luminosa. Conforme ad essere installata in ambienti con uso di videotermini secondo la norma UNI EN 12464-1.

Darklight specular aluminium diffuser with "batwing" emission. Luminance values <math><1000\text{ cd/m}^2</math> for angles >math>65^\circ</math>. Internal anti-glare opal polycarbonate film for a better light uniformity. Suitable for installation in workplaces with the use of video terminals according to EN 12464-1 standard.

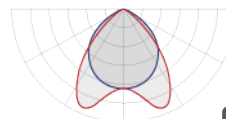

UGR <math><19</math>

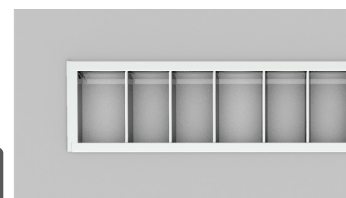

PST

Diffusore in policarbonato opale satinato a finitura liscia, ideale per una distribuzione uniforme.

Diffuser in glazed opal polycarbonate with smooth finish, ideal for uniform distribution.

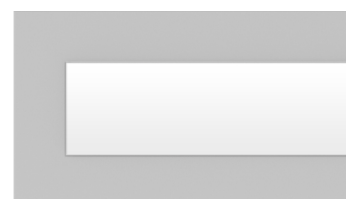
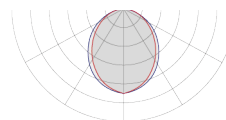

Touch

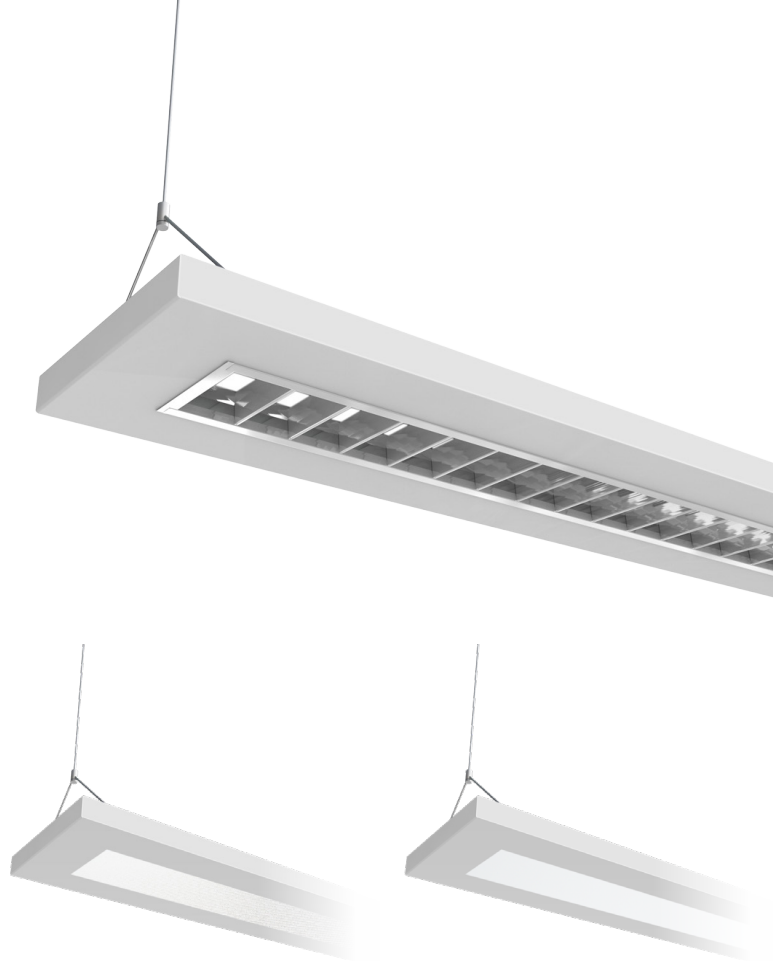

Caratteristiche tecniche

Technical Characteristics

Corpo	Lamiera di acciaio	Body	Sheet-steel
Colore	<ul style="list-style-type: none"> ○ Bianco Dry (RAL 9003) ● Grigio Dry (RAL 9006) Su richiesta: ● Altri colori	Colour	<ul style="list-style-type: none"> ○ Dry white (RAL 9003) ● Dry grey (RAL 9006) On request: ● Other colours available
Gruppo ottico	<ul style="list-style-type: none"> • PMO - policarbonato microprismatico (UGR<19) • DLM - darklight (UGR<19) • PST - policarbonato opale satinato 	Optical group	<ul style="list-style-type: none"> • PMO - microprismatic polycarbonate (UGR<19) • DLM - darklight (UGR<19) • PST - glazed opal polycarbonate
Cablaggio	<ul style="list-style-type: none"> • LED ON/OFF con driver integrato • LED DALI con driver integrato • LED DALI SENSOR con driver integrato Su richiesta: • Kit di EMERGENZA (autonomia 1/3 h)	Wiring	<ul style="list-style-type: none"> • LED ON/OFF with integrated driver • LED DALI with integrated driver • LED DALI SENSOR with integrated driver On request: • EMERGENCY kit (1/3 h autonomy)
Grado di protezione	IP 20	Protection degree	IP 20

Sorgenti LED

LED sources

IRC	<ul style="list-style-type: none"> • >80 Su richiesta: <ul style="list-style-type: none"> • >90 	CRI	<ul style="list-style-type: none"> • >80 On request: <ul style="list-style-type: none"> • >90
Temp. colore	<ul style="list-style-type: none"> • 3000 K • 4000 K Su richiesta: • TUNABLE WHITE 2700-6500 K	Colour Temp.	<ul style="list-style-type: none"> • 3000 K • 4000 K On request: • TUNABLE WHITE 2700-6500 K

Accessori (da ordinare separatamente)
Accessories (to be ordered separately)

Giunti / Joints



STAFFA D'UNIONE

UNION BRACKET

Cod. / Code KFS352000

Per l'installazione in linea continua, in acciaio zincato. Completo di viti di fissaggio.

Galvanized steel union bracket for continuous line installation. Fixing screws included.



MODULO CIECO ANGOLARE

ANGULAR INFILL MODULE

Cod. / Code IN35200X

Lamiera di acciaio verniciata di colore bianco dry. Staffe di unione incluse.

Dry white powder coated sheet-steel. Union brackets included.

- **4L** : giunto a 2 vie / 2-way joint
- **4T** : giunto a 3 vie / 3-way joint
- **4** : giunto a 4 vie / 4-way joint



MODULO CIECO LINEARE

LINEAR INFILL MODULE

Cod. / Code MC35200X

Lamiera di acciaio verniciata di colore bianco dry. Staffe di unione incluse.

Dry white powder coated sheet-steel. Union brackets included.

- **40655** : L = 655 mm
- **41255** : L = 1255 mm
- **41555** : L = 1555 mm

Sospensione / Suspension



L = 1700 mm
 Ø 0,75 mmq

KIT SOSPENSIONE

SUSPENSION KIT

Cod. / Code KS10004X

Rosone quadrato elettrificato (100x100mmx25mm) di colore bianco dry con morsettiera 2P+T; cavi di sospensione metallici ad archetto (pz.2/kit) e cavo elettrificato trasparente:

- **3** - cavo di alimentazione a 3 poli (ON/OFF) / 3 poles feeding cable (ON/OFF)
- **5** - cavo di alimentazione a 5 poli (DALI e ON/OFF + emergenza) / 5 poles feeding cable (DALI and ON/OFF + emergency)



L = 2000 mm
 Ø 0,75 mmq

CAVO DI ALIMENTAZIONE TRASPARENTE
TRANSPARENT ELECTRIFIED FEEDING CABLE

Cod. / Code CVTXX075L020

- **3** poli (ON/OFF) / poles (ON/OFF)
- **5** poli (DALI e ON/OFF + emergenza) / poles (DALI and ON/OFF + emergency)
- **7** poli (DALI + emergenza) / poles (DALI + emergency)



L = 2000 mm

CAVO DI SOSPENSIONE

SUSPENSION CABLE

Cod. / Code KS009

È necessario ordinare 2 pz per ogni lampada.
It is necessary to order 2 pcs. for each lamp.



ROSONE QUADRATO ELETTRIFICATO

ELECTRIFIED SQUARE CEILING ROSE

Cod. / Code KS02504E

Lamiera di acciaio verniciato di colore bianco dry, 2 fori per il passaggio del cavo di alimentazione e di sospensione con morsettiera di connessione.
Powder coated in white dry colour sheet-steel, 2 holes for the passage of transparent power cable and suspension cable, with terminal block.

PMO

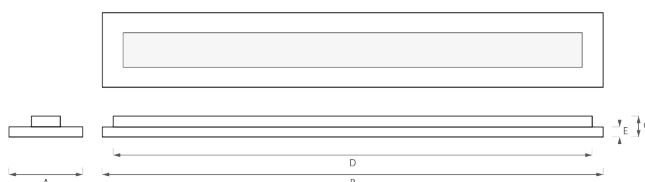

Potenza Power [W]	Temp. colore Colour Temp. [K]	IRC CRI	Flusso lum. Lum. flux [lm]	Efficienza lum. Lum. effic. [lm / W]	Dimensioni/Dimensions [mm]					Cod. / Code LED	Cod. / Code LED DALI	Cod. / Code LED DALI SENSOR
					A	B	C	D	E			
○ Bianco Dry / Dry white												
26	3000	>80	2496	96	185	1255	52	1200	25	352700017	352700019	352700211
26	4000	>80	2678	103	185	1255	52	1200	25	352700065	352700067	352700212
33	3000	>80	3168	96	185	1555	52	1500	25	352700021	352700023	352700213
33	4000	>80	3399	103	185	1555	52	1500	25	352700069	352700071	352700214
48	3000	>80	4608	96	185	1255	52	1200	25	352700025	352700027	352700215
48	4000	>80	4944	103	185	1255	52	1200	25	352700073	352700075	352700216
60	3000	>80	5760	96	185	1555	52	1500	25	352700029	352700031	352700217
60	4000	>80	6180	103	185	1555	52	1500	25	352700077	352700079	352700218

DLM

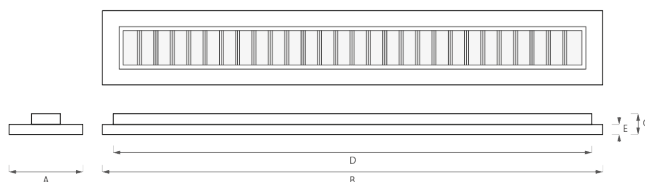
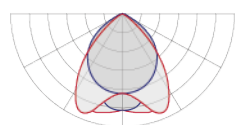

Potenza Power [W]	Temp. colore Colour Temp. [K]	IRC CRI	Flusso lum. Lum. flux [lm]	Efficienza lum. Lum. effic. [lm / W]	Dimensioni/Dimensions [mm]					Cod. / Code LED	Cod. / Code LED DALI	Cod. / Code LED DALI SENSOR
					A	B	C	D	E			
○ Bianco Dry / Dry white												
26	3000	>80	2600	100	185	1255	52	1200	25	352700001	352700003	352700219
26	4000	>80	2782	107	185	1255	52	1200	25	352700049	352700051	352700220
33	3000	>80	3300	100	185	1555	52	1500	25	352700005	352700007	352700221
33	4000	>80	3531	107	185	1555	52	1500	25	352700053	352700055	352700222
48	3000	>80	4800	100	185	1255	52	1200	25	352700009	352700011	352700223
48	4000	>80	5136	107	185	1255	52	1200	25	352700057	352700059	352700224
60	3000	>80	6000	100	185	1555	52	1500	25	352700013	352700015	352700225
60	4000	>80	6420	107	185	1555	52	1500	25	352700061	352700063	352700226

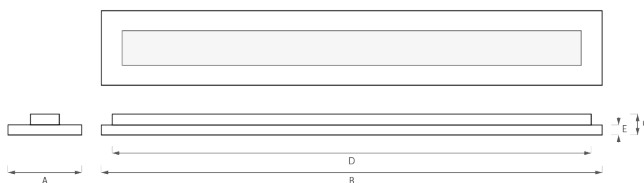
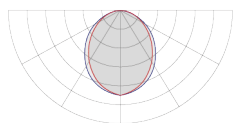

PST



Potenza Power [W]	Temp. colore Colour Temp. [K]	IRC CRI	Flusso lum. Lum. flux [lm]	Efficienza lum. Lum. effic. [lm / W]	Dimensioni/Dimensions [mm]					Cod. / Code LED	Cod. / Code LED DALI	Cod. / Code LED DALI SENSOR
					A	B	C	D	E			
○ Bianco Dry / Dry white												
26	3000	>80	2002	77	185	1255	52	1200	25	352700033	352700035	352700227
26	4000	>80	2158	83	185	1255	52	1200	25	352700081	352700083	352700228
33	3000	>80	2541	77	185	1555	52	1500	25	352700037	352700039	352700229
33	4000	>80	2739	83	185	1555	52	1500	25	352700085	352700087	352700230
48	3000	>80	3696	77	185	1255	52	1200	25	352700041	352700043	352700231
48	4000	>80	3984	83	185	1255	52	1200	25	352700089	352700091	352700232
60	3000	>80	4620	77	185	1555	52	1500	25	352700045	352700047	352700233
60	4000	>80	4980	83	185	1555	52	1500	25	352700093	352700095	352700234



1) Il flusso effettivo potrebbe avere una tolleranza del ±10%. / The effective flux could have a tolerance of ±10%.

Touch IND

IP20



Caratteristiche tecniche

Technical Characteristics

Corpo	Lamiera di acciaio	Body	Sheet-steel
Colore	<ul style="list-style-type: none"> ○ Bianco Dry (RAL 9003) ● Grigio Dry (RAL 9006) Su richiesta: ● Altri colori	Colour	<ul style="list-style-type: none"> ○ Dry white (RAL 9003) ● Dry grey (RAL 9006) On request: ● Other colours available
Gruppo ottico	· Policarbonato	Optical group	· Polycarbonate
Cablaggio	<ul style="list-style-type: none"> · LED ON/OFF con driver integrato · LED DALI con driver integrato Su richiesta: <ul style="list-style-type: none"> · Kit di EMERGENZA (autonomia 1/3 h) · LED + SN con sensore di presenza e driver integrato 	Wiring	<ul style="list-style-type: none"> · LED ON/OFF with integrated driver · LED DALI with integrated driver On request: <ul style="list-style-type: none"> · EMERGENCY kit (1/3 h autonomy) · LED + SN with integrated sensor and driver
Grado di protezione	IP 20	Protection degree	IP 20

Sorgenti LED

LED sources

IRC	<ul style="list-style-type: none"> · >80 Su richiesta: <ul style="list-style-type: none"> · >90 	CRI	<ul style="list-style-type: none"> · >80 On request: <ul style="list-style-type: none"> · >90
Temp. colore	<ul style="list-style-type: none"> · 3000 K · 4000 K Su richiesta: <ul style="list-style-type: none"> · TUNABLE WHITE 2700-6500 K 	Colour Temp.	<ul style="list-style-type: none"> · 3000 K · 4000 K On request: <ul style="list-style-type: none"> · TUNABLE WHITE 2700-6500 K

Giunti / Joints



STAFFA D'UNIONE
UNION BRACKET

Cod. / Code KFS352000
 Per l'installazione in linea continua, in acciaio zincato. Completo di viti di fissaggio.
Galvanized steel union bracket for continuous line installation. Fixing screws included.



MODULO CIECO ANGOLARE
ANGULAR INFILL MODULE

Cod. / Code IN35200X
 Lamiera di acciaio verniciata di colore bianco dry. Staffe di unione incluse.
Dry white powder coated sheet-steel. Union brackets included.

- **4L** : giunto a 2 vie / 2-way joint
- **4T** : giunto a 3 vie / 3-way joint
- **4** : giunto a 4 vie / 4-way joint



MODULO CIECO LINEARE
LINEAR INFILL MODULE

Cod. / Code MC35200X
 Lamiera di acciaio verniciata di colore bianco dry. Staffe di unione incluse.
Dry white powder coated sheet-steel. Union brackets included.

- **40655** : L = 655 mm
- **41255** : L = 1255 mm
- **41555** : L = 1555 mm

Sospensione / Suspension



L = 1700 mm
 Ø 0,75 mmq

KIT SOSPENSIONE
SUSPENSION KIT

Cod. / Code KS10004X
 Rosone quadrato elettrificato (100x100mmx 25mm) di colore bianco dry con morsettiera 2P+T; cavi di sospensione metallici ad archetto (pz.2/kit) e cavo elettrificato trasparente:

- **3** - cavo di alimentazione a 3 poli (ON/OFF)/ 3 poles feeding cable (ON/OFF)
- **5** - cavo di alimentazione a 5 poli (DALI e ON/OFF + emergenza) / 5 poles feeding cable (DALI and ON/OFF + emergency)



L = 2000 mm
 Ø 0,75 mmq

CAVO DI ALIMENTAZIONE TRASPARENTE
TRANSPARENT ELECTRIFIED FEEDING CABLE

Cod. / Code CVTXX075L020

- **3** poli (ON/OFF)/poles (ON/OFF)
- **5** poli (DALI e ON/OFF + emergenza)/ poles (DALI and ON/OFF + emergency)
- **7** poli (DALI + emergenza)/ poles (DALI + emergency)



L = 2000 mm

CAVO DI SOSPENSIONE
SUSPENSION CABLE

Cod. / Code KS009
 È necessario ordinare 2 pz per ogni lampada.
It is necessary to order 2 pcs. for each lamp.



ROSONE QUADRATO ELETTRIFICATO
ELECTRIFIED SQUARE CEILING ROSE

Cod. / Code KS02504E
 Lamiera di acciaio verniciato di colore bianco dry, 2 fori per il passaggio del cavo di alimentazione e di sospensione con morsettiera di connessione.
Powder coated in white dry colour sheet-steel, 2 holes for the passage of transparent power cable and suspension cable, with terminal block.

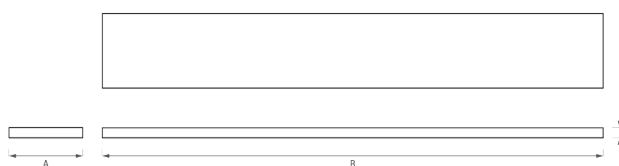
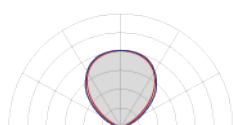

Potenza Power [W]	Temp. colore Colour Temp. [K]	IRC CRI	Flusso lum. Lum. flux [lm]	Efficienza lum. Lum. effic. [lm / W]	Dimensioni/Dimensions [mm]			Cod. / Code LED	Cod. / Code LED DALI
					A	B	C		
○ Bianco Dry / Dry white									
26	3000	>80	3770	145	185	1255	25	352800001	352800003
26	4000	>80	4056	156	185	1255	25	352800017	352800019
33	3000	>80	4785	145	185	1555	25	352800005	352800007
33	4000	>80	5148	156	185	1555	25	352800021	352800023
48	3000	>80	6960	145	185	1255	25	352800009	352800011
48	4000	>80	7488	156	185	1255	25	352800025	352800027
60	3000	>80	8700	145	185	1555	25	352800013	352800015
60	4000	>80	9360	156	185	1555	25	352800029	352800031

1) Il flusso effettivo potrebbe avere una tolleranza del ±10%. / The effective flux could have a tolerance of ±10%.

Touch I/D



Caratteristiche tecniche

Technical Characteristics

Corpo	Lamiera di acciaio	Body	Sheet-steel
Colore	<ul style="list-style-type: none"> ○ Bianco Dry (RAL 9003) ● Grigio Dry (RAL 9006) Su richiesta: ● Altri colori	Colour	<ul style="list-style-type: none"> ○ Dry white (RAL 9003) ● Dry grey (RAL 9006) On request: ● Other colours available
Gruppo ottico	<ul style="list-style-type: none"> • PMO - policarbonato microprismatico (UGR<19) • DLM - darklight (UGR<19) • PST - policarbonato opale satinato • POL - policarbonato opale (luce indiretta) 	Optical group	<ul style="list-style-type: none"> • PMO - microprismatic polycarbonate (UGR<19) • DLM - darklight (UGR<19) • PST - glazed opal polycarbonate • POL - opal polycarbonate (indirect light)
Cablaggio	<ul style="list-style-type: none"> • LED ON/OFF con driver integrato • LED DALI con driver integrato • LED DALI SENSOR con driver integrato Su richiesta: • Kit di EMERGENZA (autonomia 1/3 h)	Wiring	<ul style="list-style-type: none"> • LED ON/OFF with integrated driver • LED DALI with integrated driver • LED DALI SENSOR with integrated driver On request: • EMERGENCY kit (1/3 h autonomy)
Grado di protezione	IP 20	Protection degree	IP 20

Sorgenti LED

LED sources

IRC	<ul style="list-style-type: none"> • >80 Su richiesta: <ul style="list-style-type: none"> • >90 	CRI	<ul style="list-style-type: none"> • >80 On request: <ul style="list-style-type: none"> • >90
Temp. colore	<ul style="list-style-type: none"> • 3000 K • 4000 K Su richiesta: • TUNABLE WHITE 2700-6500 K	Colour Temp.	<ul style="list-style-type: none"> • 3000 K • 4000 K On request: • TUNABLE WHITE 2700-6500 K

Accessori (da ordinare separatamente)

Accessories (to be ordered separately)

Giunti / Joints



STAFFA D'UNIONE

UNION BRACKET

Cod. / Code KFS352000

Per l'installazione in linea continua, in acciaio zincato. Completo di viti di fissaggio.

Galvanized steel union bracket for continuous line installation. Fixing screws included.



MODULO CIECO ANGOLARE

ANGULAR INFILL MODULE

Cod. / Code IN35200X

Lamiera di acciaio verniciata di colore bianco dry. Staffe di unione incluse.

Dry white powder coated sheet-steel. Union brackets included.

- **4L**: giunto a 2 vie / 2-way joint
- **4T**: giunto a 3 vie / 3-way joint
- **4**: giunto a 4 vie / 4-way joint



MODULO CIECO LINEARE

LINEAR INFILL MODULE

Cod. / Code MC35200X

Lamiera di acciaio verniciata di colore bianco dry. Staffe di unione incluse.

Dry white powder coated sheet-steel. Union brackets included.

- **40655**: L = 655 mm
- **41255**: L = 1255 mm
- **41555**: L = 1555 mm

Sospensione / Suspension



L = 1700 mm
Ø 0,75 mmq

KIT SOSPENSIONE

SUSPENSION KIT

Cod. / Code KS10004X

Rosone quadrato elettrificato (100x100mmx 25mm) di colore bianco dry con morsettiera 2P+T; cavi di sospensione metallici ad archetto (pz.2/kit) e cavo elettrificato trasparente:

- **3** - cavo di alimentazione a 3 poli (ON/OFF) / 3 poles feeding cable (ON/OFF)
- **5** - cavo di alimentazione a 5 poli (DALI e ON/OFF + emergenza) / 5 poles feeding cable (DALI and ON/OFF + emergency)



L = 2000 mm
Ø 0,75 mmq

CAVO DI ALIMENTAZIONE TRASPARENTE

TRANSPARENT ELECTRIFIED FEEDING CABLE

Cod. / Code CVTXX075L020

- **3** poli (ON/OFF) / poles (ON/OFF)
- **5** poli (DALI e ON/OFF + emergenza) / poles (DALI and ON/OFF + emergency)
- **7** poli (DALI + emergenza) / poles (DALI + emergency)



L = 2000 mm

CAVO DI SOSPENSIONE

SUSPENSION CABLE

Cod. / Code KS009

È necessario ordinare 2 pz per ogni lampada. It is necessary to order 2 pcs. for each lamp.



ROSONE QUADRATO ELETTRIFICATO

ELECTRIFIED SQUARE CEILING ROSE

Cod. / Code KS02504E

Lamiera di acciaio verniciato di colore bianco dry, 2 fori per il passaggio del cavo di alimentazione e di sospensione con morsettiera di connessione. Powder coated in white dry colour sheet-steel, 2 holes for the passage of transparent power cable and suspension cable, with terminal block.

PMO

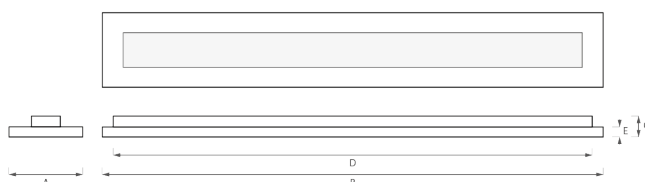
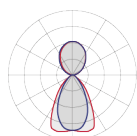

Potenza Power [W]	Temp. colore Colour Temp. [K]	IRC CRI	Flusso lum. Lum. flux [lm]	Efficienza lum. Lum. effic. [lm / W]	Dimensioni/Dimensions [mm]					Cod. / Code LED	Cod. / Code LED DALI	Cod. / Code LED DALI SENSOR
					A	B	C	D	E			
○ Bianco Dry / Dry white												
↑26 ↓26	3000	>80	↑1560 ↓2496	↑60 ↓96	185	1255	52	1200	25	352600004	352600007	352600228
↑26 ↓26	4000	>80	↑1664 ↓2678	↑64 ↓103	185	1255	52	1200	25	352600011	352600008	352600229
↑26 ↓33	3000	>80	↑1560 ↓3168	↑60 ↓96	185	1555	52	1500	25	352600025	352600028	352600230
↑26 ↓33	4000	>80	↑1664 ↓3399	↑64 ↓103	185	1555	52	1500	25	352600012	352600014	352600231
↑26 ↓48	3000	>80	↑1560 ↓4608	↑60 ↓96	185	1255	52	1200	25	352600026	352600027	352600232
↑26 ↓48	4000	>80	↑1664 ↓4944	↑64 ↓103	185	1255	52	1200	25	352600019	352600017	352600233
↑26 ↓60	3000	>80	↑1560 ↓5760	↑60 ↓96	185	1555	52	1500	25	352600001	352600029	352600234
↑26 ↓60	4000	>80	↑1664 ↓6180	↑64 ↓103	185	1555	52	1500	25	352600002	352600003	352600235

DLM

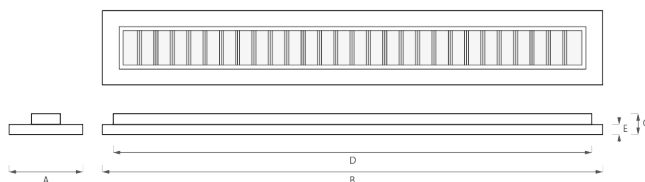
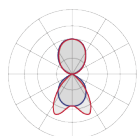

Potenza Power [W]	Temp. colore Colour Temp. [K]	IRC CRI	Flusso lum. Lum. flux [lm]	Efficienza lum. Lum. effic. [lm / W]	Dimensioni/Dimensions [mm]					Cod. / Code LED	Cod. / Code LED DALI	Cod. / Code LED DALI SENSOR
					A	B	C	D	E			
○ Bianco Dry / Dry white												
↑26 ↓26	3000	>80	↑1560 ↓2600	↑60 ↓100	185	1255	52	1200	25	352600047	352600039	352600236
↑26 ↓26	4000	>80	↑1664 ↓2782	↑64 ↓107	185	1255	52	1200	25	352600059	352600051	352600237
↑26 ↓33	3000	>80	↑1560 ↓3300	↑60 ↓100	185	1555	52	1500	25	352600048	352600040	352600238
↑26 ↓33	4000	>80	↑1664 ↓3531	↑64 ↓107	185	1555	52	1500	25	352600060	352600052	352600239
↑26 ↓48	3000	>80	↑1560 ↓4800	↑60 ↓100	185	1255	52	1200	25	352600049	352600041	352600240
↑26 ↓48	4000	>80	↑1664 ↓5136	↑64 ↓107	185	1255	52	1200	25	352600061	352600053	352600241
↑26 ↓60	3000	>80	↑1560 ↓6000	↑60 ↓100	185	1555	52	1500	25	352600050	352600042	352600242
↑26 ↓60	4000	>80	↑1664 ↓6420	↑64 ↓107	185	1555	52	1500	25	352600062	352600054	352600243

↑ Luce indiretta/ Indirect light

↓ Luce diretta/ Direct light

PST

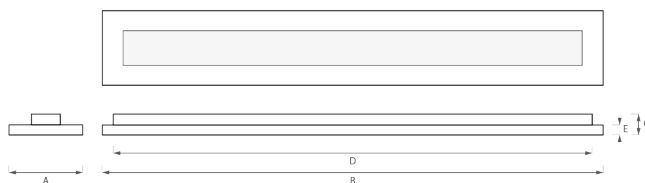
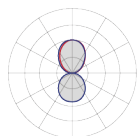

Potenza Power [W]	Temp. colore Colour Temp. [K]	IRC CRI	Flusso lum. Lum. flux [lm]	Efficienza lum. Lum. effic. [lm / W]	Dimensioni/Dimensions [mm]					Cod. / Code LED	Cod. / Code LED DALI	Cod. / Code LED DALI SENSOR
					A	B	C	D	E			
○ Bianco Dry / Dry white												
↑26 ↓26	3000	>80	↑1560 ↓2002	↑60 ↓77	185	1255	52	1200	25	352600133	352600141	352600244
↑26 ↓26	4000	>80	↑1664 ↓2158	↑64 ↓83	185	1255	52	1200	25	352600145	352600153	352600245
↑26 ↓33	3000	>80	↑1560 ↓2541	↑60 ↓77	185	1555	52	1500	25	352600131	352600139	352600246
↑26 ↓33	4000	>80	↑1664 ↓2739	↑64 ↓83	185	1555	52	1500	25	352600143	352600151	352600247
↑26 ↓48	3000	>80	↑1560 ↓3696	↑60 ↓77	185	1255	52	1200	25	352600134	352600142	352600248
↑26 ↓48	4000	>80	↑1664 ↓3984	↑64 ↓83	185	1255	52	1200	25	352600146	352600154	352600249
↑26 ↓60	3000	>80	↑1560 ↓4620	↑60 ↓77	185	1555	52	1500	25	352600132	352600140	352600250
↑26 ↓60	4000	>80	↑1664 ↓4980	↑64 ↓83	185	1555	52	1500	25	352600144	352600152	352600251



↑ Luce indiretta/Indirect light

↓ Luce diretta/Direct light

1) Il flusso effettivo potrebbe avere una tolleranza del ±10%. / The effective flux could have a tolerance of ±10%.



INCASSO

RECESSED

Scegli in base al controsoffitto

Choose according to the false ceiling

	CLIP-IN A TENUTA <i>Clip-in false ceiling concealed structure</i>	ATENA SYNCRO EVO <i>ATENA Syncro Evo® Ceiling</i>	CALPESTABILE <i>Clip-in false ceiling</i>
---	---	---	---

Controsoffitto ispezionabile a pannelli modulari con struttura nascosta (Profili Continentale / Triangolo / Tubolare). Si consiglia la pendinatura di sicurezza al solaio.

Hook-down modular panels false ceiling with clip-in structure (Profiles Continental / Triangle / Tube). Safe anchoring on the concrete slab recommended.

Controsoffitto Atena Syncro evo® a pannelli modulari per orditura a T base 24, specifico per ambienti ospedalieri. Pannello in aggancio su struttura a T24, le speciali molle del pannello esercitano una ferma pressione sulla guarnizione in neoprene, installata lungo i lati del pannello, garantendo la salubrità necessaria al locale. Si consiglia la pendinatura di sicurezza al solaio.

Atena Syncro evo® metal tiles false ceiling for T24 grid, properly conceived for hospitals. The special springs, hooked on T24 grid, make a high pressure on neoprene gasket installed along the tile, guaranteeing the environment cleaning. Safe anchoring on the concrete slab recommended.

Controsoffitto calpestabile, ispezionabile dall'alto, in pannelli modulari (del tipo sandwich o monopanel).

L'installazione dei corpi illuminanti avviene in perfetta continuità con il controsoffitto tramite staffe regolabili in altezza (30 ÷ 90 mm).

Walkable false ceiling, inspectable from above, in modular panels (sandwich or monopanel type). The product frame allows an installation in perfect continuity with the false ceiling, mounting kit with adjustable fixing brackets supplied (30 ÷ 90 mm).

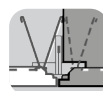

TAURUS	TAURUS/N	TAURUS/EVO	TAURUS/TOP
PLAY ⁽¹⁾	-	-	-
PLAN ⁽¹⁾	-	-	-
ROUND ABOUT	-	-	-
MANTA	-	-	-
SLIM	-	-	-
AT/FIRE	-	-	-
SKIN ⁽¹⁾	-	-	-
4 SIDE	-	-	-
DUOLED	-	-	-
PLATE	-	-	-
AT/1	-	-	-
AT/184	-	-	-
AT/284	-	-	-
AT/20	-	-	-
AT/C 230	-	-	-
AT/S 180	-	-	-
STREET P/30 ⁽¹⁾	-	-	-

Versione standard/ Standard version

Versione su richiesta/ On request version

¹⁾ Corpi illuminanti provvisti di accessorio per l'installazione a plafone, da ordinare separatamente. / Lighting fittings with optional accessory for ceiling installation, to be ordered separately.

Scegli in base al controsoffitto

Choose according to the false ceiling

CARTONGESSO

Plasterboard

Controsoffitto in cartongesso. L'installazione dei corpi illuminanti avviene tramite staffe di fissaggio regolabili. Si consiglia la pendinatura di sicurezza al solaio.

Plasterboard false ceiling. The installation of the lighting fittings occurs by adjustable fixing brackets. Safe anchoring on the concrete slab recommended.

LAY-IN

Lay-in false ceiling

Controsoffitto con struttura a vista. L'installazione dei corpi illuminanti avviene direttamente in appoggio alla struttura portante con profilo a "T", senza staffe di fissaggio. Si consiglia la pendinatura di sicurezza al solaio.

False ceiling with lay-in structure. The installation of lighting fittings occurs directly on the structure with "T" profile. Safe anchoring on the concrete slab recommended.

CLIP-IN

Clip-in false ceiling

Controsoffitto ispezionabile a pannelli modulari con struttura nascosta. L'installazione dei corpi illuminanti avviene in totale integrazione con il controsoffitto grazie ad un kit di montaggio con staffe regolabili in altezza. Si consiglia la pendinatura di sicurezza al solaio.

Hook-down modular panels false ceiling with clip-in structure. The installation of lighting fittings occurs in a full integration with the false ceiling structure thanks to a mounting kit with height-adjustable brackets. Safe anchoring on the concrete slab recommended.

D1 IN GESSO ALLEGERITO

D1 false ceiling in lightened gypsum

Controsoffitto con struttura nascosta D1 (con profili a "T" base 15/24mm) e pannelli con sezione ad incastro, realizzati in gesso alleggerito e/o legno. L'installazione dei corpi illuminanti avviene creando una continuità su tutta la struttura, utilizzando un kit di montaggio composto da staffe regolabili in altezza. Si consiglia la pendinatura di sicurezza al solaio.

False ceiling with clip-in structure D1 ("T" profiles 15/24mm base) and panels with snap-fit section made of lightened gypsum and/or wood. The installation of the lighting fittings occurs by creating continuity over the entire structure, using a mounting kit with height-adjustable brackets. Safe anchoring on the concrete slab recommended.

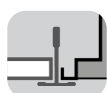

TAURUS/N	TAURUS/V	-	-
PLAY/N	PLAY	PLAY/N	-
PLAN/N	PLAN	PLAN/N	PLAN/D1
ROUND ABOUT	ROUND ABOUT	ROUND ABOUT	-
MANTA	MANTA	-	-
SLIM	SLIM	SLIM	SLIM/D1
-	AT/FIRE	-	-
SKIN	SKIN	-	-
-	4 SIDE	-	-
-	DUOLED	-	-
-	PLATE	-	-
-	-	-	-
-	-	-	-
-	-	-	-
-	-	-	-
AT/C 230	-	-	-
-	-	-	-
-	-	-	-

Scegli in base al controsoffitto

Choose according to the false ceiling

EASY-LINE

EASY-LINE false ceiling

Controsoffitto ispezionabile a pannelli modulari con struttura nascosta (Profili Continentale / Triangolo / Tubolare). Si consiglia la pendinatura di sicurezza al solaio.

Hook-down modular panels false ceiling with clip-in structure (Profiles Continental / Triangle / Tube). Safe anchoring on the concrete slab recommended.

TEGULAR LAY-IN

TEGULAR LAY-IN false ceiling

Controsoffitto Atena Syncro evo® a pannelli modulari per orditura a T base 24, specifico per ambienti ospedalieri. Pannello in aggancio su struttura a T24, le speciali molle del pannello esercitano una ferma pressione sulla guarnizione in neoprene, installata lungo i lati del pannello, garantendo la salubrità necessaria al locale. Si consiglia la pendinatura di sicurezza al solaio.

Atena Syncro evo® metal tiles false ceiling for T24 grid, properly conceived for hospitals. The special springs, hooked on T24 grid, make a high pressure on neoprene gasket installed along the tile, guaranteeing the environment cleaning. Safe anchoring on the concrete slab recommended.

GRIGLIATO A MAGLIA UNICA

Metal cells false ceiling with continuous open cell system

Controsoffitto calpestabile, ispezionabile dall'alto, in pannelli modulari (del tipo sandwich o monopanel). L'installazione dei corpi illuminanti avviene in perfetta continuità con il controsoffitto tramite staffe regolabili in altezza (30 ÷ 90 mm).

Walkable false ceiling, inspectable from above, in modular panels (sandwich or monopanel type). The product frame allows an installation in perfect continuity with the false ceiling, mounting kit with adjustable fixing brackets supplied (30 ÷ 90 mm).

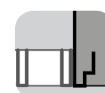

TAURUS	-	-	-
PLAY ⁽¹⁾	-	-	-
PLAN ⁽¹⁾	PLAN/EASY LINE	PLAN/T	PLAN/G
ROUND ABOUT	-	ROUND ABOUT/T	-
MANTA	-	-	-
SLIM	SLIM/EASY LINE	-	-
AT/FIRE	-	-	-
SKIN ⁽¹⁾	-	-	-
4 SIDE	4 SIDE/EASY LINE	-	-
DUOLED	-	-	-
PLATE	-	-	-
AT/1	-	-	-
AT/184	-	-	-
AT/284	-	-	-
AT/20	-	-	-
AT/C 230	-	-	-
AT/S 180	-	-	-
STREET P/30 ⁽¹⁾	-	-	-

Versione standard/ Standard version

Versione su richiesta/ On request version

¹⁾ Corpi illuminanti provvisti di accessorio per l'installazione a plafone, da ordinare separatamente. / Lighting fittings with optional accessory for ceiling installation, to be ordered separately.



Taurus

Incasso | Recessed

Linea di corpi illuminanti a tenuta stagna (IP65) destinata all'utilizzo in **ambienti medicali quali laboratori, camere bianche, sale operatorie e sale di degenza,**

*Lighting fittings with protection degree IP65, suitable to be installed in **medical environment as laboratories, hospitals, operating theatres and clean rooms.***

Taurus/N

IP 65/20 IP65



Taurus/V

IP 65/20 IP65



Taurus EVO

IP65

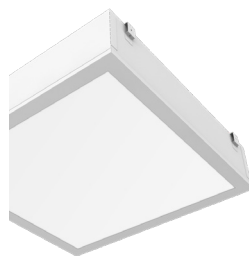

Taurus TOP

IP 65/40

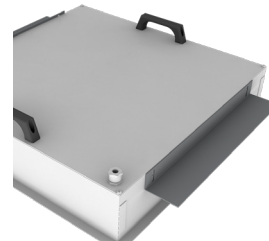

Caratteristiche tecniche

Technical Characteristics

Corpo	Lamiera di acciaio	Body	Sheet-steel
Colore	○ Bianco opaco (RAL 9003) <u>Su richiesta:</u> · Verniciatura anti-microbica	Colour	○ Matt white (RAL 9003) <u>On request:</u> · Antimicrobial coating
Gruppo ottico	· PMO - policarbonato microprismatico (UGR<19) · VTR + PMO - vetro temprato e policarbonato microprismatico (UGR<19) · MOT - metacrilato opale	Optical group	· PMO - microprismatic polycarbonate (UGR<19) · VTR + PMO - tempered glass and microprismatic polycarbonate (UGR<19) · MOT - opal methacrylate
Cablaggio	· LED-F ON/OFF con fusibile di protezione e driver integrato · LED-F DALI con fusibile di protezione e driver integrato <u>Su richiesta:</u> · Circuito RGB DMX · Kit di EMERGENZA (autonomia 1/3 h)	Wiring	· LED-F ON/OFF with fused terminal block and integrated driver · LED-F DALI with fused terminal block and integrated driver <u>On request:</u> · DMX RGB Circuit · EMERGENCY kit (1/3 h autonomy)
Grado di protezione	· IP 65 (TAURUS/N; TAURUS/V; TAURUS/EVO) · IP 65/20 (TAURUS/N; TAURUS/V) · IP 65/40 (TAURUS/TOP)	Protection degree	· IP 65 (TAURUS/N; TAURUS/V; TAURUS/EVO) · IP 65/20 (TAURUS/N) · IP 65/40 (TAURUS/TOP)

Sorgenti LED

LED sources

IRC	· >80 · >90	CRI	· >80 · >90
Temp. colore	· 4000 K <u>Su richiesta:</u> · 3000 K · 5000 K · TUNABLE WHITE 2700-6500 K · LED RGB	Colour Temp.	· 4000 K <u>On request:</u> · 3000 K · 5000 K · TUNABLE WHITE 2700-6500 K · RGB LED

Gruppi ottici

Optical groups

PMO

Diffusore in policarbonato microprismatico anabbagliante. Valori di luminanza $< 3000 \text{ cd/m}^2$ per angoli $> 65^\circ$. Film interno in policarbonato opale anabbagliante per una maggiore uniformità luminosa. Conforme ad essere installata in ambienti con uso di videotermini secondo la norma UNI EN 12464-1.

Diffuser made of anti-glare microprismatic polycarbonate. Luminance values $< 3000 \text{ cd/m}^2$ for angles $> 65^\circ$. Internal anti-glare opal polycarbonate film for a better light uniformity. Suitable for installation in workplaces with the use of video terminals according to EN 12464-1 standard.

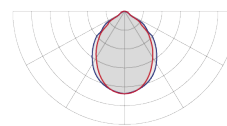

UGR
 < 19

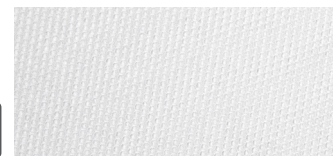

VTR + PMO

Diffusore in vetro temprato di sicurezza e policarbonato microprismatico. Valori di luminanza $< 3000 \text{ cd/m}^2$ per angoli $> 65^\circ$. Film interno in policarbonato opale anabbagliante per una maggiore uniformità luminosa. Conforme ad essere installata in ambienti con uso di videotermini secondo la norma UNI EN 12464-1.

Diffuser made of secure transparent tempered glass and anti-glare microprismatic polycarbonate. Luminance values $< 3000 \text{ cd/m}^2$ for angles $> 65^\circ$. Internal anti-glare opal polycarbonate film for a better light uniformity. Suitable for installation in workplaces with the use of video terminals according to EN 12464-1 standard.

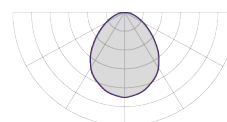

UGR
 < 19



MOT

Diffusore in metacrilato opale ad alta trasmittanza, ideale per una distribuzione uniforme.

Diffuser in opal methacrylate with high transmittance, ideal for uniform distribution.

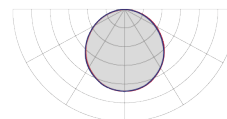

Taurus/N

IP65 IP 65/20

Incasso | Recessed

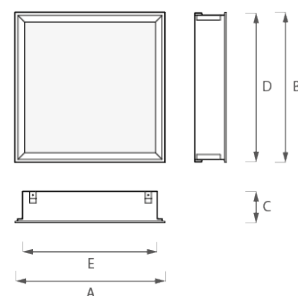

Dimensioni/Dimensions [mm]

A	B	C	D	E
600	600	126	545	576
300	1200	126	245	1176
600	1200	126	545	1176

Tipologia di installazione Type of installation

CARTONGESSO Plasterboard

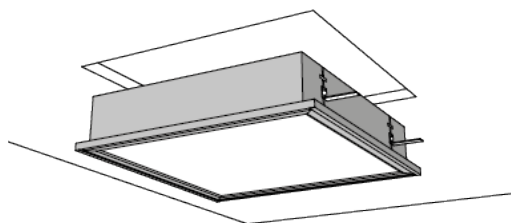

IP
65/20



580mm x 580mm
280mm x 1180mm
580mm x 1180mm



Controsoffitto in cartongesso. L'installazione dei corpi illuminanti avviene tramite staffe di fissaggio regolabili. Si consiglia la pendinatura di sicurezza al solaio.

Plasterboard false ceiling.

The installation of the lighting fittings occurs by adjustable fixing brackets. Safe anchoring on the concrete slab recommended.

CONTROSOFFITTO CLIP-IN A TENUTA Clip-in false ceiling concealed structure

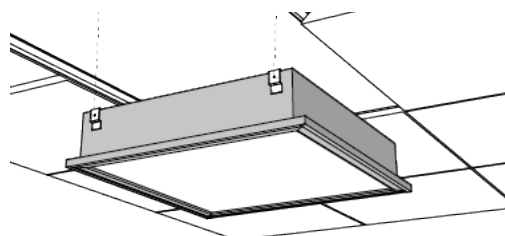

IP
65/20 IP65

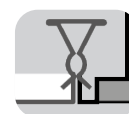

Controsoffitto ispezionabile a pannelli modulari con struttura nascosta (Profili Continentale / Triangolo / Tubolare). Installazione del corpo illuminante tramite pendinatura al solaio.

Hook-down modular panels false ceiling with clip-in structure (Profiles Continental / Triangle / Tube). The installation must be performed suspending the luminaire to the concrete ceiling.

Adatto per controsoffitti con:
Suitable for false ceiling with:

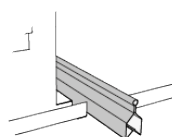

Profilo continentale
Continental profile

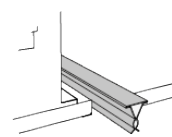

Profilo a triangolo
Triangle profile

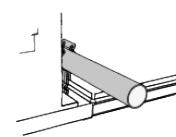

Profilo tubolare
Tube profile
Ø 22mm

Versioni
Versions

Taurus/V

IP65 IP65/20

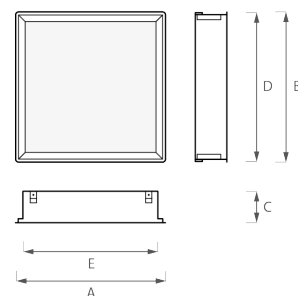

Dimensioni / Dimensions [mm]

A	B	C	D	E
595	595	126	580	538
295	1195	126	1180	238
595	1195	126	1180	538

Tipologia di installazione
Type of installation

CONTROSOFFITTO LAY-IN
Lay-in false ceiling

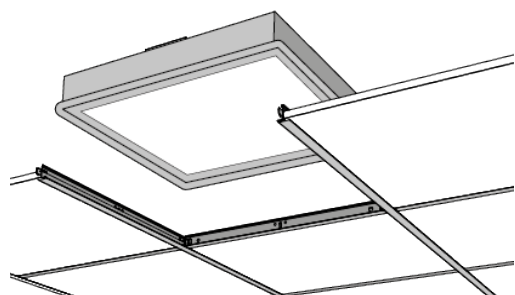

IP65/20 IP65

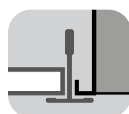

Controsoffitto con struttura a vista. L'installazione dei corpi illuminanti avviene direttamente in appoggio alla struttura portante con profilo a "T", senza staffe di fissaggio. Si consiglia la pendinatura di sicurezza al solaio.

False ceiling with lay-in structure. The installation of lighting fittings occurs directly on the structure with "T" profile. Safe anchoring on the concrete slab recommended.

Versioni
Versions

Taurus EVO



Incasso | Recessed

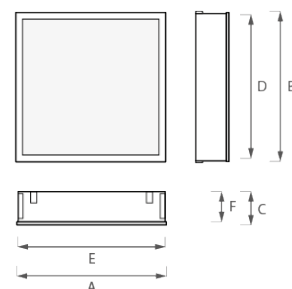
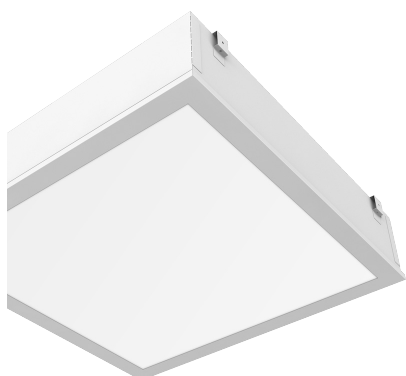

Dimensioni / Dimensions [mm]

A	B	C	D	E	F
600	600	135	592	591	118
600	1200	135	1192	591	118

Tipologia di installazione Type of installation

CONTROSOFFITTO

 **Atena Syncro Evo®**

ATENA Syncro Evo® Ceiling

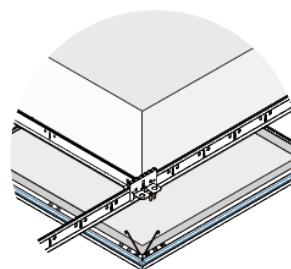
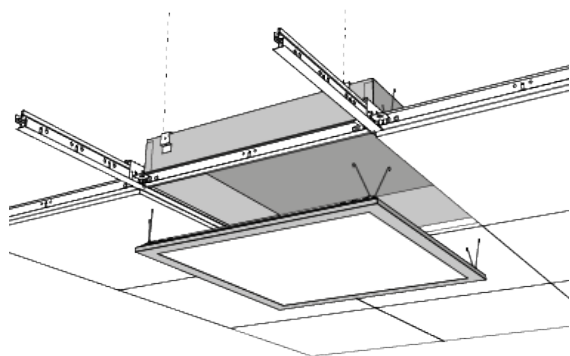

**Sistema di tenuta Syncro Evo
composto da molla di tenuta
e guarnizione perimetrale**

*Syncro Evo sealing system
consisting of sealing spring
and perimeter gasket*

IP65



Controsoffitto Atena Syncro evo® a pannelli modulari per orditura a T base 24, specifico per ambienti ospedalieri. Pannello in aggancio su struttura a T24, le speciali molle del pannello esercitano una ferma pressione sulla guarnizione in neoprene, installata lungo i lati del pannello, garantendo la salubrità necessaria al locale. Si consiglia la pendinatura di sicurezza al solaio.

Atena Syncro evo® metal tiles false ceiling for T24 grid, properly conceived for hospitals. The special springs, hooked on T24 grid, make a high pressure on neoprene gasket installed along the tile, guaranteeing the environment cleaning. Safe anchoring on the concrete slab recommended.

Versioni
Versions

Taurus TOP

IP
65/40

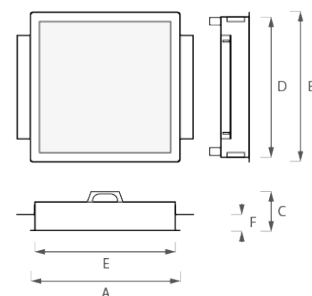
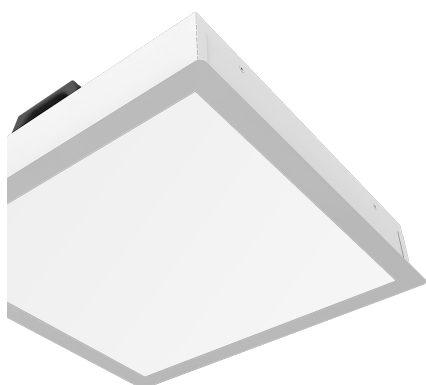

Dimensioni / Dimensions [mm]					
A	B	C	D	E	F
650	650	170	612	612	30 ÷ 90
350	1250	170	312	1212	30 ÷ 90
650	1250	170	612	1212	30 ÷ 90

Tipologia di installazione
Type of installation

CONTROSOFFITTO LAY-IN
Lay-in false ceiling

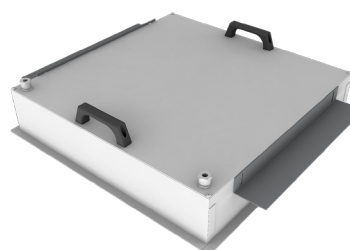
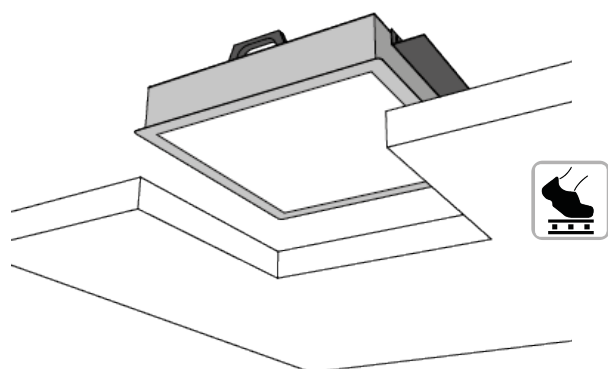

**Maniglie ergonomiche
per agevolare l'installazione dall'alto
e guarnizione di tenuta**
*Ergonomic handles
to facilitate installation from above and
sealing gasket*

IP
65/40



635mm x 635mm
335mm x 1235mm
635mm x 1235mm

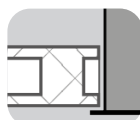

Controsoffitto calpestabile, ispezionabile dall'alto, in pannelli modulari (del tipo sandwich o monopanel). L'installazione dei corpi illuminanti avviene in perfetta continuità con il controsoffitto tramite staffe regolabili in altezza (30 ÷ 90 mm).

Walkable false ceiling, inspectable from above, in modular panels (sandwich or monopanel type).

The product frame allows an installation in perfect continuity with the false ceiling, mounting kit with adjustable fixing brackets supplied (30 ÷ 90 mm).

VTR+PMO

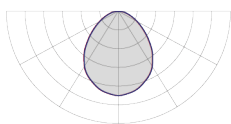

Taurus/N IP65

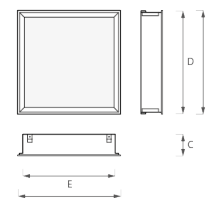

Potenza Power [W]	Temp. colore Colour Temp. [K]	IRC CRI	Flusso lum. Lum. flux [lm]	Efficienza lum. Lum. effic. [lm / W]	Dimensioni / Dimensions [mm]						Cod. / Code LED-F	Cod. / Code LED-F DALI
					A	B	C	D	E			
38	4000	>80	4180	110	600	600	126	576	545	-	435100177	435100179
38	4000	>90	3344	88	600	600	126	576	545	-	435100181	435100183
44	4000	>80	4840	110	600	600	126	576	545	-	435100185	435100187
44	4000	>90	3872	88	600	600	126	576	545	-	435100189	435100191
50	4000	>80	5500	110	600	600	126	576	545	-	435100193	435100195
50	4000	>90	4400	88	600	600	126	576	545	-	435100197	435100199
78	4000	>80	9516	122	600	600	126	576	545	-	435100201	435100203
78	4000	>90	7644	98	600	600	126	576	545	-	435100205	435100207
52	4000	>80	6344	122	300	1200	126	1176	245	-	435100233	435100235
52	4000	>90	5096	98	300	1200	126	1176	245	-	435100237	435100239
78	4000	>80	9516	122	300	1200	126	1176	245	-	435100241	435100243
78	4000	>90	7644	98	300	1200	126	1176	245	-	435100245	435100247
88	4000	>80	9680	110	600	1200	126	1176	545	-	435100209	435100211
88	4000	>90	7744	88	600	1200	126	1176	545	-	435100213	435100215
100	4000	>80	11000	110	600	1200	126	1176	545	-	435100217	435100219
100	4000	>90	8800	88	600	1200	126	1176	545	-	435100221	435100223
156	4000	>80	19032	122	600	1200	126	1176	545	-	435100225	435100227
156	4000	>90	15288	98	600	1200	126	1176	545	-	435100229	435100231

Taurus/N IP65/20



Potenza Power [W]	Temp. colore Colour Temp. [K]	IRC CRI	Flusso lum. Lum. flux [lm]	Efficienza lum. Lum. effic. [lm / W]	Dimensioni / Dimensions [mm]						Cod. / Code LED-F	Cod. / Code LED-F DALI
					A	B	C	D	E			
38	4000	>80	4180	110	600	600	126	576	538	580x580	438100159	438100161
38	4000	>90	3344	88	600	600	126	576	538	580x580	438100163	438100165
44	4000	>80	4840	110	600	600	126	576	538	580x580	438100167	438100169
44	4000	>90	3872	88	600	600	126	576	538	580x580	438100171	438100173
50	4000	>80	5500	110	600	600	126	576	538	580x580	438100175	438100177
50	4000	>90	4400	88	600	600	126	576	538	580x580	438100179	438100181
78	4000	>80	9516	122	600	600	126	576	538	580x580	438100183	438100185
78	4000	>90	7644	98	600	600	126	576	538	580x580	438100187	438100189
52	4000	>80	6344	122	300	1200	126	1176	238	280x1180	438100214	438100216
52	4000	>90	5096	98	300	1200	126	1176	238	280x1180	438100218	438100220
78	4000	>80	9516	122	300	1200	126	1176	238	280x1180	438100222	438100224
78	4000	>90	7644	98	300	1200	126	1176	238	280x1180	438100226	438100228
88	4000	>80	9680	110	600	1200	126	1176	538	580x1180	438100191	438100193
88	4000	>90	7744	88	600	1200	126	1176	538	580x1180	438100195	438100197
100	4000	>80	11000	110	600	1200	126	1176	538	580x1180	438100198	438100200
100	4000	>90	8800	88	600	1200	126	1176	538	580x1180	438100202	438100204
156	4000	>80	19032	122	600	1200	126	1176	538	580x1180	438100206	438100208
156	4000	>90	15288	98	600	1200	126	1176	538	580x1180	438100210	438100212

MOT

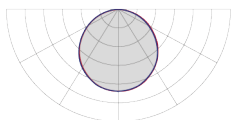

atena lux

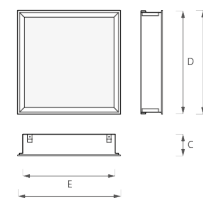

Taurus/N IP65

Potenza Power [W]	Temp. colore Colour Temp. [K]	IRC CRI	Flusso lum. Lum. flux [lm]	Efficienza lum. Lum. effic. [lm / W]	Dimensioni / Dimensions [mm]						Cod. / Code LED-F	Cod. / Code LED-F DALI
					A	B	C	D	E			
38	4000	>80	4218	111	600	600	126	576	545	-	435100176	435100178
38	4000	>90	3382	89	600	600	126	576	545	-	435100180	435100182
44	4000	>80	4884	111	600	600	126	576	545	-	435100184	435100186
44	4000	>90	3916	89	600	600	126	576	545	-	435100188	435100190
50	4000	>80	5550	111	600	600	126	576	545	-	435100192	435100194
50	4000	>90	4450	89	600	600	126	576	545	-	435100196	435100198
78	4000	>80	9672	124	600	600	126	576	545	-	435100200	435100202
78	4000	>90	7722	99	600	600	126	576	545	-	435100204	435100206
52	4000	>80	6448	124	300	1200	126	1176	245	-	435100232	435100234
52	4000	>90	5148	99	300	1200	126	1176	245	-	435100236	435100238
78	4000	>80	9672	124	300	1200	126	1176	245	-	435100240	435100242
78	4000	>90	7722	99	300	1200	126	1176	245	-	435100244	435100246
88	4000	>80	9768	111	600	1200	126	1176	545	-	435100208	435100210
88	4000	>90	7832	89	600	1200	126	1176	545	-	435100212	435100214
100	4000	>80	11100	111	600	1200	126	1176	545	-	435100216	435100218
100	4000	>90	8900	89	600	1200	126	1176	545	-	435100220	435100222
156	4000	>80	19344	124	600	1200	126	1176	545	-	435100224	435100226
156	4000	>90	15444	99	600	1200	126	1176	545	-	435100228	435100230

Taurus/N IP65/20



Potenza Power [W]	Temp. colore Colour Temp. [K]	IRC CRI	Flusso lum. Lum. flux [lm]	Efficienza lum. Lum. effic. [lm / W]	Dimensioni / Dimensions [mm]						Cod. / Code LED-F	Cod. / Code LED-F DALI
					A	B	C	D	E			
38	4000	>80	4218	111	600	600	126	576	538	580x580	438100158	438100160
38	4000	>90	3382	89	600	600	126	576	538	580x580	438100162	438100164
44	4000	>80	4884	111	600	600	126	576	538	580x580	438100166	438100168
44	4000	>90	3916	89	600	600	126	576	538	580x580	438100170	438100172
50	4000	>80	5550	111	600	600	126	576	538	580x580	438100174	438100176
50	4000	>90	4450	89	600	600	126	576	538	580x580	438100178	438100180
78	4000	>80	9672	124	600	600	126	576	538	580x580	438100182	438100184
78	4000	>90	7722	99	600	600	126	576	538	580x580	438100186	438100188
52	4000	>80	6448	124	300	1200	126	1176	238	280x1180	438100213	438100215
52	4000	>90	5148	99	300	1200	126	1176	238	280x1180	438100217	438100219
78	4000	>80	9672	124	300	1200	126	1176	238	280x1180	438100221	438100223
78	4000	>90	7722	99	300	1200	126	1176	238	280x1180	438100225	438100227
88	4000	>80	9768	111	600	1200	126	1176	538	580x1180	438100190	438100192
88	4000	>90	7832	89	600	1200	126	1176	538	580x1180	438100194	438100196
100	4000	>80	11100	111	600	1200	126	1176	538	580x1180	438100157	438100199
100	4000	>90	8900	89	600	1200	126	1176	538	580x1180	438100201	438100203
156	4000	>80	19344	124	600	1200	126	1176	538	580x1180	438100205	438100207
156	4000	>90	15444	99	600	1200	126	1176	538	580x1180	438100209	438100211

1) Il flusso effettivo potrebbe avere una tolleranza del ±10%. / The effective flux could have a tolerance of ±10%.

VTR+PMO

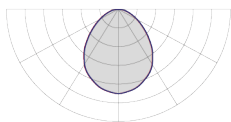

Taurus/V IP65

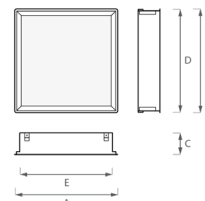

Potenza Power [W]	Temp. colore Colour Temp. [K]	IRC CRI	Flusso lum. Lum. flux [lm]	Efficienza lum. Lum. effic. [lm / W]	Dimensioni / Dimensions [mm]					Cod. / Code LED-F	Cod. / Code LED-F DALI
					A	B	C	D	E		
38	4000	>80	4180	110	595	595	126	580	545	434100346	434100347
38	4000	>90	3344	88	595	595	126	580	545	434100348	434100349
44	4000	>80	4840	110	595	595	126	580	545	434100350	434100351
44	4000	>90	3872	88	595	595	126	580	545	434100352	434100353
50	4000	>80	5500	110	595	595	126	580	545	434100354	434100355
50	4000	>90	4400	88	595	595	126	580	545	434100303	434100309
78	4000	>80	9516	122	595	595	126	580	545	434100356	434100357
78	4000	>90	7644	98	595	595	126	580	545	434100358	434100359
52	4000	>80	6344	122	295	1195	126	1180	245	434100360	434100361
52	4000	>90	5096	98	295	1195	126	1180	245	434100362	434100363
78	4000	>80	9516	122	295	1195	126	1180	245	434100364	434100365
78	4000	>90	7644	98	295	1195	126	1180	245	434100366	434100367
88	4000	>80	9680	110	595	1195	126	1180	545	434100368	434100369
88	4000	>90	7744	88	595	1195	126	1180	545	434100370	434100371
100	4000	>80	11000	110	595	1195	126	1180	545	434100372	434100373
100	4000	>90	8800	88	595	1195	126	1180	545	434100374	434100375
156	4000	>80	19032	122	595	1195	126	1180	545	434100376	434100377
156	4000	>90	15288	98	595	1195	126	1180	545	434100378	434100379

Taurus/V IP65/20



Potenza Power [W]	Temp. colore Colour Temp. [K]	IRC CRI	Flusso lum. Lum. flux [lm]	Efficienza lum. Lum. effic. [lm / W]	Dimensioni / Dimensions [mm]					Cod. / Code LED-F	Cod. / Code LED-F DALI
					A	B	C	D	E		
38	4000	>80	4180	110	595	595	126	580	538	437100051	437100052
38	4000	>90	3344	88	595	595	126	580	538	437100053	437100054
44	4000	>80	4840	110	595	595	126	580	538	437100055	437100056
44	4000	>90	3872	88	595	595	126	580	538	437100057	437100058
50	4000	>80	5500	110	595	595	126	580	538	437100059	437100060
50	4000	>90	4400	88	595	595	126	580	538	437100013	437100061
78	4000	>80	9516	122	595	595	126	580	538	437100062	437100063
78	4000	>90	7644	98	595	595	126	580	538	437100064	437100065
52	4000	>80	6344	122	295	1195	126	1180	238	437100066	437100067
52	4000	>90	5096	98	295	1195	126	1180	238	437100068	437100069
78	4000	>80	9516	122	295	1195	126	1180	238	437100070	437100071
78	4000	>90	7644	98	295	1195	126	1180	238	437100072	437100073
88	4000	>80	9680	110	595	1195	126	1180	538	437100074	437100075
88	4000	>90	7744	88	595	1195	126	1180	538	437100076	437100077
100	4000	>80	11000	110	595	1195	126	1180	538	437100078	437100079
100	4000	>90	8800	88	595	1195	126	1180	538	437100080	437100081
156	4000	>80	19032	122	595	1195	126	1180	538	437100082	437100083
156	4000	>90	15288	98	595	1195	126	1180	538	437100084	437100085

MOT

Taurus/V IP65

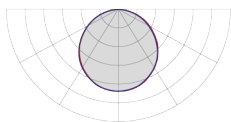

atena lux

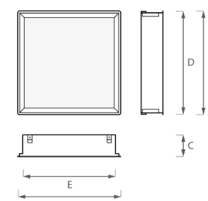

Potenza Power [W]	Temp. colore Colour Temp. [K]	IRC CRI	Flusso lum. Lum. flux [lm]	Efficienza lum. Lum. effic. [lm / W]	Dimensioni / Dimensions [mm]					Cod. / Code LED-F	Cod. / Code LED-F DALI
					A	B	C	D	E		
38	4000	>80	4218	111	595	595	126	580	545	434100313	434100314
38	4000	>90	3382	89	595	595	126	580	545	434100315	434100316
44	4000	>80	4884	111	595	595	126	580	545	434100317	434100312
44	4000	>90	3916	89	595	595	126	580	545	434100318	434100311
50	4000	>80	5550	111	595	595	126	580	545	434100319	434100320
50	4000	>90	4450	89	595	595	126	580	545	434100321	434100310
78	4000	>80	9672	124	595	595	126	580	545	434100322	434100323
78	4000	>90	7722	99	595	595	126	580	545	434100324	434100325
52	4000	>80	6448	124	295	1195	126	1180	245	434100326	434100327
52	4000	>90	5148	99	295	1195	126	1180	245	434100328	434100329
78	4000	>80	9672	124	295	1195	126	1180	245	434100330	434100331
78	4000	>90	7722	99	295	1195	126	1180	245	434100332	434100333
88	4000	>80	9768	111	595	1195	126	1180	545	434100334	434100335
88	4000	>90	7832	89	595	1195	126	1180	545	434100336	434100337
100	4000	>80	11100	111	595	1195	126	1180	545	434100338	434100339
100	4000	>90	8900	89	595	1195	126	1180	545	434100340	434100341
156	4000	>80	19344	124	595	1195	126	1180	545	434100342	434100343
156	4000	>90	15444	99	595	1195	126	1180	545	434100344	434100345

Taurus/V IP65/20



Potenza Power [W]	Temp. colore Colour Temp. [K]	IRC CRI	Flusso lum. Lum. flux [lm]	Efficienza lum. Lum. effic. [lm / W]	Dimensioni / Dimensions [mm]					Cod. / Code LED-F	Cod. / Code LED-F DALI
					A	B	C	D	E		
38	4000	>80	4218	111	595	595	126	580	538	437100016	437100017
38	4000	>90	3382	89	595	595	126	580	538	437100018	437100019
44	4000	>80	4884	111	595	595	126	580	538	437100012	437100020
44	4000	>90	3916	89	595	595	126	580	538	437100021	437100022
50	4000	>80	5550	111	595	595	126	580	538	437100023	437100024
50	4000	>90	4450	89	595	595	126	580	538	437100025	437100026
78	4000	>80	9672	124	595	595	126	580	538	437100027	437100028
78	4000	>90	7722	99	595	595	126	580	538	437100029	437100030
52	4000	>80	6448	124	295	1195	126	1180	238	437100031	437100032
52	4000	>90	5148	99	295	1195	126	1180	238	437100033	437100034
78	4000	>80	9672	124	295	1195	126	1180	238	437100035	437100036
78	4000	>90	7722	99	295	1195	126	1180	238	437100037	437100038
88	4000	>80	9768	111	595	1195	126	1180	538	437100039	437100040
88	4000	>90	7832	89	595	1195	126	1180	538	437100041	437100042
100	4000	>80	11100	111	595	1195	126	1180	538	437100043	437100044
100	4000	>90	8900	89	595	1195	126	1180	538	437100045	437100046
156	4000	>80	19344	124	595	1195	126	1180	538	437100047	437100048
156	4000	>90	15444	99	595	1195	126	1180	538	437100049	437100050

1) Il flusso effettivo potrebbe avere una tolleranza del ±10%. / The effective flux could have a tolerance of ±10%.

Taurus/EVO

PMO

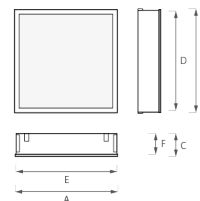
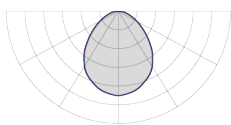

Incasso | Recessed

Potenza Power [W]	Temp. colore Colour Temp. [K]	IRC CRI	Flusso lum. Lum. flux [lm]	Efficienza lum. Lum. effic. [lm / W]	Dimensioni / Dimensions [mm]						Cod. / Code LED-F	Cod. / Code LED-F DALI
					A	B	C	D	E	F		
38	4000	>80	4446	117	600	600	135	592	591	118	442000112	442000113
38	4000	>90	3572	94	600	600	135	592	591	118	442000120	442000121
44	4000	>80	5148	117	600	600	135	592	591	118	442000126	442000127
44	4000	>90	4136	94	600	600	135	592	591	118	442000134	442000135
50	4000	>80	5850	117	600	600	135	592	591	118	442000138	442000139
50	4000	>90	4700	94	600	600	135	592	591	118	442000146	442000147
78	4000	>80	10218	131	600	600	135	592	591	118	442000321	442000322
78	4000	>90	8190	105	600	600	135	592	591	118	442000323	442000324
88	4000	>80	10296	117	600	1200	135	1192	591	118	442000325	442000326
88	4000	>90	8272	94	600	1200	135	1192	591	118	442000327	442000328
100	4000	>80	11700	117	600	1200	135	1192	591	118	442000329	442000330
100	4000	>90	9400	94	600	1200	135	1192	591	118	442000331	442000332
156	4000	>80	20436	131	600	1200	135	1192	591	118	442000333	442000334
156	4000	>90	16380	105	600	1200	135	1192	591	118	442000335	442000336

MOT

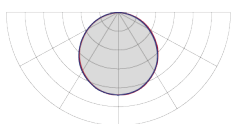

Potenza Power [W]	Temp. colore Colour Temp. [K]	IRC CRI	Flusso lum. Lum. flux [lm]	Efficienza lum. Lum. effic. [lm / W]	Dimensioni / Dimensions [mm]						Cod. / Code LED-F	Cod. / Code LED-F DALI
					A	B	C	D	E	F		
38	4000	>80	4218	111	600	600	135	592	591	118	442000108	442000109
38	4000	>90	3382	89	600	600	135	592	591	118	442000116	442000117
44	4000	>80	4884	111	600	600	135	592	591	118	442000009	442000010
44	4000	>90	3916	89	600	600	135	592	591	118	442000130	442000131
50	4000	>80	5550	111	600	600	135	592	591	118	442000031	442000032
50	4000	>90	4450	89	600	600	135	592	591	118	442000035	442000036
78	4000	>80	10218	124	600	600	135	592	591	118	442000249	442000250
78	4000	>90	7722	99	600	600	135	592	591	118	442000251	442000252
88	4000	>80	9768	111	600	1200	135	1192	591	118	442000253	442000254
88	4000	>90	7832	89	600	1200	135	1192	591	118	442000255	442000256
100	4000	>80	11100	111	600	1200	135	1192	591	118	442000257	442000258
100	4000	>90	8900	89	600	1200	135	1192	591	118	442000259	442000260
156	4000	>80	19344	124	600	1200	135	1192	591	118	442000261	442000262
156	4000	>90	15444	99	600	1200	135	1192	591	118	442000263	442000264

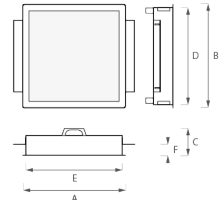

Taurus/TOP

VTR+PMO

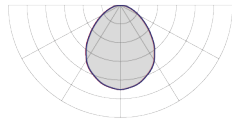

Potenza Power [W]	Temp. colore Colour Temp. [K]	IRC CRI	Flusso lum. Lum. flux [lm]	Efficienza lum. Lum. effic. [lm / W]	Dimensioni / Dimensions [mm]						Cod. / Code LED-F	Cod. / Code LED-F DALI
					A	B	C	D	E	F		
38	4000	>80	4180	110	650	650	170	612	612	30÷90	439100001	439100005
38	4000	>90	3344	88	650	650	170	612	612	30÷90	439100009	439100013
44	4000	>80	4840	110	650	650	170	612	612	30÷90	439100002	439100006
44	4000	>90	3872	88	650	650	170	612	612	30÷90	439100010	439100014
50	4000	>80	5500	110	650	650	170	612	612	30÷90	439100003	439100007
50	4000	>90	4400	88	650	650	170	612	612	30÷90	439100011	439100015
78	4000	>80	9516	122	650	650	170	612	612	30÷90	439100004	439100008
78	4000	>90	7644	98	650	650	170	612	612	30÷90	439100012	439100016
52	4000	>80	6344	122	350	1250	170	312	1212	30÷90	439100017	439100018
52	4000	>90	5096	98	350	1250	170	312	1212	30÷90	439100021	439100022
78	4000	>80	9516	122	350	1250	170	312	1212	30÷90	439100019	439100020
78	4000	>90	7644	98	350	1250	170	312	1212	30÷90	439100023	439100024
88	4000	>80	9680	110	650	1250	170	612	1212	30÷90	439100025	439100028
88	4000	>90	7744	88	650	1250	170	612	1212	30÷90	439100031	439100034
100	4000	>80	11000	110	650	1250	170	612	1212	30÷90	439100026	439100029
100	4000	>90	8800	88	650	1250	170	612	1212	30÷90	439100032	439100035
156	4000	>80	19032	122	650	1250	170	612	1212	30÷90	439100027	439100030
156	4000	>90	15288	98	650	1250	170	612	1212	30÷90	439100033	439100036

MOT

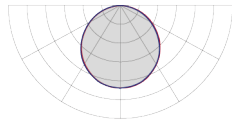

Potenza Power [W]	Temp. colore Colour Temp. [K]	IRC CRI	Flusso lum. Lum. flux [lm]	Efficienza lum. Lum. effic. [lm / W]	Dimensioni / Dimensions [mm]						Cod. / Code LED-F	Cod. / Code LED-F DALI
					A	B	C	D	E	F		
38	4000	>80	4218	111	650	650	170	612	612	30÷90	439100037	439100038
38	4000	>90	3382	89	650	650	170	612	612	30÷90	439100039	439100040
44	4000	>80	4884	111	650	650	170	612	612	30÷90	439100041	439100042
44	4000	>90	3916	89	650	650	170	612	612	30÷90	439100043	439100044
50	4000	>80	5550	111	650	650	170	612	612	30÷90	439100045	439100046
50	4000	>90	4450	89	650	650	170	612	612	30÷90	439100047	439100048
78	4000	>80	9672	124	650	650	170	612	612	30÷90	439100049	439100050
78	4000	>90	7722	99	650	650	170	612	612	30÷90	439100051	439100052
52	4000	>80	6448	124	350	1250	170	312	1212	30÷90	439100053	439100054
52	4000	>90	5148	99	350	1250	170	312	1212	30÷90	439100055	439100056
78	4000	>80	9672	124	350	1250	170	312	1212	30÷90	439100057	439100058
78	4000	>90	7722	99	350	1250	170	312	1212	30÷90	439100059	439100060
88	4000	>80	9768	111	650	1250	170	612	1212	30÷90	439100061	439100062
88	4000	>90	7832	89	650	1250	170	612	1212	30÷90	439100063	439100064
100	4000	>80	11100	111	650	1250	170	612	1212	30÷90	439100065	439100066
100	4000	>90	8900	89	650	1250	170	612	1212	30÷90	439100067	439100068
156	4000	>80	19344	124	650	1250	170	612	1212	30÷90	439100069	439100070
156	4000	>90	15444	99	650	1250	170	612	1212	30÷90	439100071	439100072

1) Il flusso effettivo potrebbe avere una tolleranza del ±10%. / The effective flux could have a tolerance of ±10%.

Play

IP40 UGR <16 UGR <19

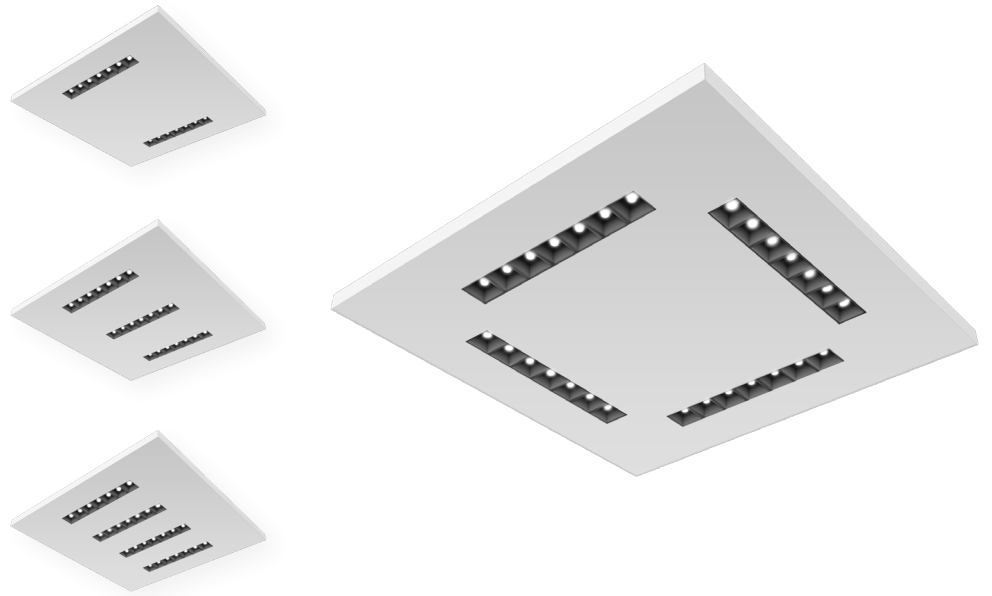
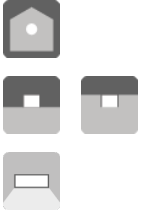

Play

IP40

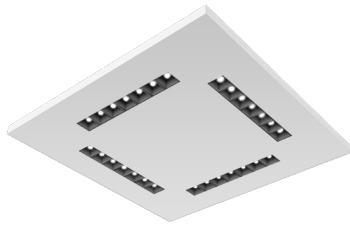

Play/N

IP40

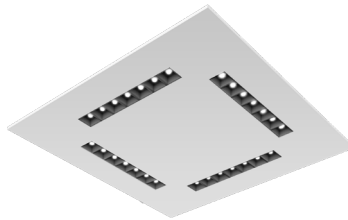

Play/UV

Luce + Sanificazione
Light + Sanitization

Su richiesta / On request

PLAY/UV è un corpo illuminante dal design minimale e versatile che svolge una costante azione sanificante attraverso l'utilizzo di lampade germicide UV-C insieme al generatore di ioni bipolari. Il dispositivo di sanitizzazione è integrato all'interno dell'apparecchio e questo ne permette il funzionamento continuo anche in presenza di persone, tutelandone la salute.

PLAY / UV is a fitting with a minimal and versatile design that carries out a constant sanitizing action through the use of UV-C germicidal lamps together with the bipolar ion generator.

The sanitization device is integrated inside the device and this allows its continuous operation even in the presence of people, protecting their health.

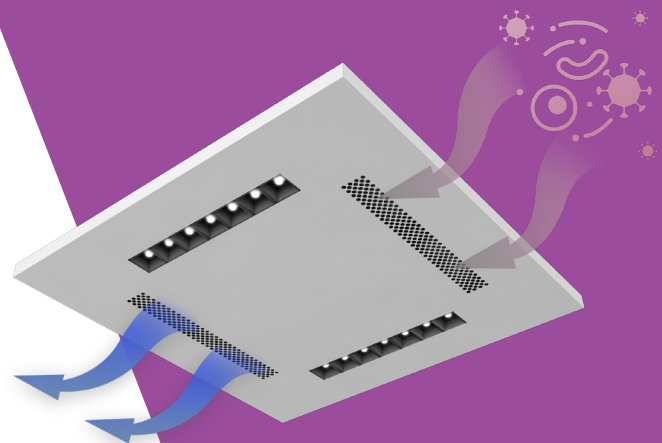

Caratteristiche tecniche

Technical Characteristics

Corpo	Lamiera d'acciaio	Body	Steel sheet
Colore	<input type="radio"/> Bianco preverniciato <u>Su richiesta:</u> <input checked="" type="radio"/> Altri colori	Colour	<input type="radio"/> Pre-painted white <u>On request:</u> <input checked="" type="radio"/> Other colours available
Gruppo ottico	<ul style="list-style-type: none"> • OFC - lenti modulari apertura di fascio 50°, cover in policarbonato nero (UGR<19) • OFC80 - lenti modulari apertura di fascio 80°, cover in policarbonato nero (UGR<16) <u>Su richiesta:</u> <ul style="list-style-type: none"> • OFC.B - lenti modulari apertura di fascio 50°, cover in policarbonato bianco (UGR<19) • OFC80.B - lenti modulari apertura di fascio 80°, cover in policarbonato bianco (UGR<16) 	Optical group	<ul style="list-style-type: none"> • OFC - 50° beam modular lenses, black polycarbonate cover (UGR<19) • OFC80 - 80° beam modular lenses, black polycarbonate cover (UGR<16) <u>Su richiesta:</u> <ul style="list-style-type: none"> • OFC.B - 50° beam modular lenses, white polycarbonate cover (UGR<19) • OFC80.B - 80° beam modular lenses, white polycarbonate cover (UGR<16)
Cablaggio	<ul style="list-style-type: none"> • LED ON/OFF con driver integrato • LED DALI con driver integrato <u>Su richiesta:</u> <ul style="list-style-type: none"> • Kit di EMERGENZA (autonomia 1/3 h) 	Wiring	<ul style="list-style-type: none"> • LED ON/OFF with integrated driver • LED DALI with integrated driver <u>On request:</u> <ul style="list-style-type: none"> • EMERGENCY kit (1/3 h autonomy)
Grado di protezione	• IP 40	Protection degree	• IP 40

Sorgenti LED

LED sources

IRC	• >90	CRI	• >90
Temp. colore	<ul style="list-style-type: none"> • 3000 K • 4000 K 	Colour Temp.	<ul style="list-style-type: none"> • 3000 K • 4000 K

Gruppi ottici

Optical groups

OFC

Ottica composta da lenti modulari con cover nera ad emissione luminosa controllata. Apertura di fascio 50°. Valori di luminanza < 200 cd/m² per angoli > 65°.

Conforme ad essere installata in ambienti con uso di videoterminali secondo la norma UNI EN 12464-1.

Optics composed of modular lenses with black cover and controlled light emission. 50° beam angle. Luminance values <200 cd/m² for angles >65°.

Suitable for installation in workplaces with the use of video terminals according to EN 12464-1 standard.

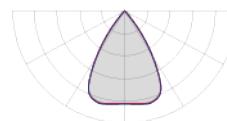

UGR
<16

OFC80

Ottica composta da lenti modulari con cover nera ad emissione luminosa controllata. Apertura di fascio 80°. Valori di luminanza < 200 cd/m² per angoli > 65°.

Conforme ad essere installata in ambienti con uso di videoterminali secondo la norma UNI EN 12464-1.

Optics composed of modular lenses with black cover and with controlled light emission. 80° beam angle. Luminance values <200 cd/m² for angles >65°.

Suitable for installation in workplaces with the use of video terminals according to EN 12464-1 standard.

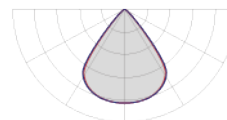

UGR
<19

Play

Incasso | Recessed

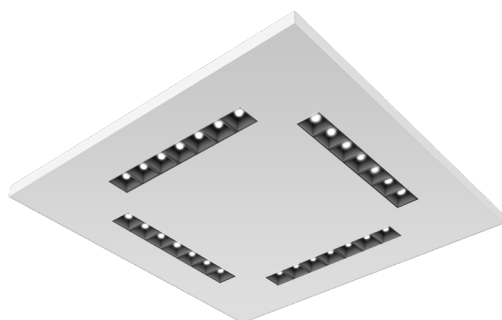

Dimensioni/Dimensions [mm]		
A	B	C
595	595	23
147,5	595	23
147,5	1195	23
295	595	23
295	1195	23

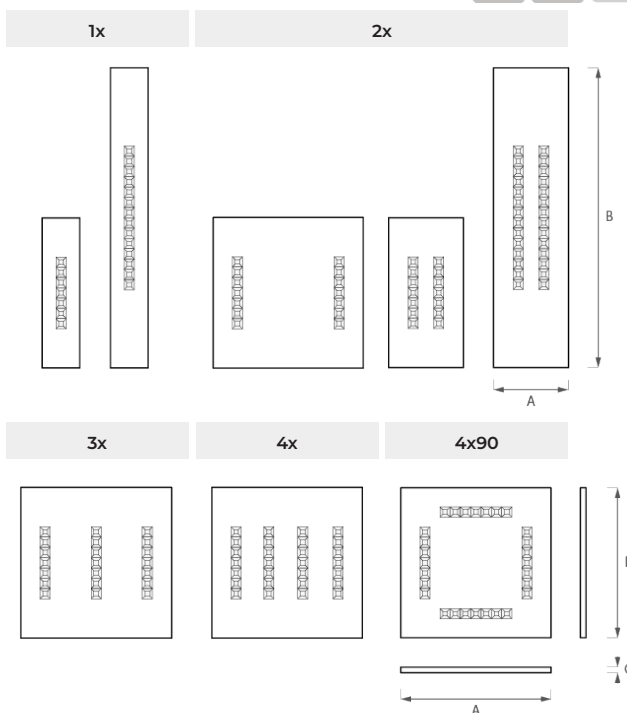

Tipologia di installazione Type of installation

CONTROSOFFITTO LAY-IN Lay-in false ceiling

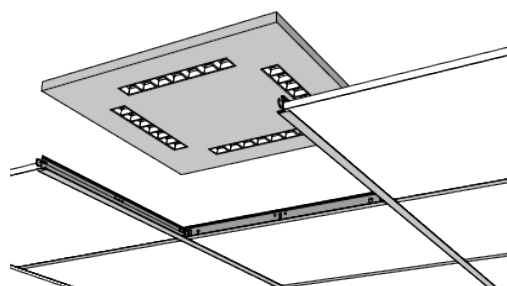

IP40



Controsoffitto con struttura a vista. L'installazione dei corpi illuminanti avviene direttamente in appoggio alla struttura portante con profilo a "T", senza staffe di fissaggio. Si consiglia la pendinatura di sicurezza al solaio.

False ceiling with lay-in structure. The installation of lighting fittings occurs directly on the structure with "T" profile. Safe anchoring on the concrete slab recommended.

PLAFONE Ceiling

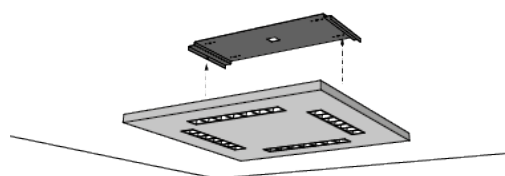

IP40



Accessori (da ordinare separatamente)
Accessories (to be ordered separately)

PIASTRA DI FISSAGGIO A PLAFONE CEILING FIXING PLATE

Cod. / Code KMP1788000X

- **606** 600x600mm
- **306** 300x600mm
- **312** 300x1200mm
- **106** 150x600mm
- **112** 150x1200mm



CORNICE DI FISSAGGIO A PLAFONE FRAME FOR CEILING APPLICATION

Cod. / Code KMP1788230X

Colore bianco

White colour

- **6070B**: 600x600 mm
- **3170B**: 300x1200 mm



H= 70 mm

Versioni
Versions

Play/N

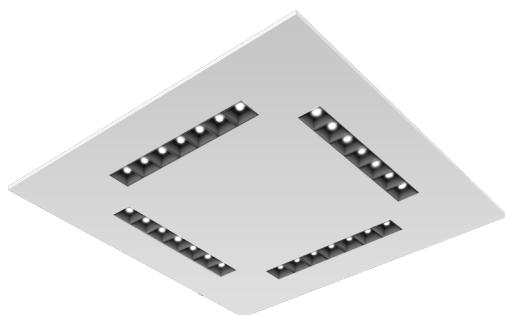

Dimensioni/Dimensions [mm]		
A	B	C
599	599	100

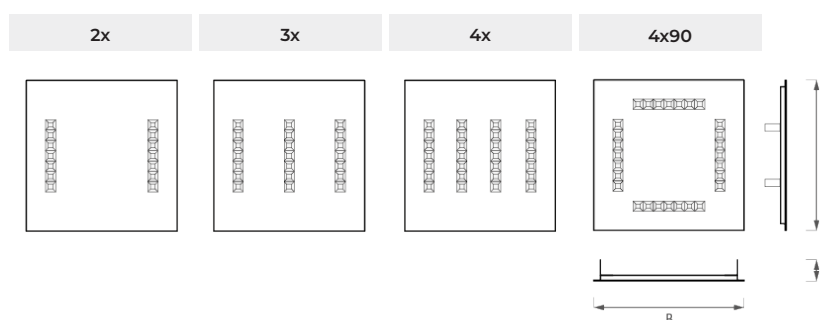

Tipologia di installazione Type of installation

CARTONGESSO Plasterboard

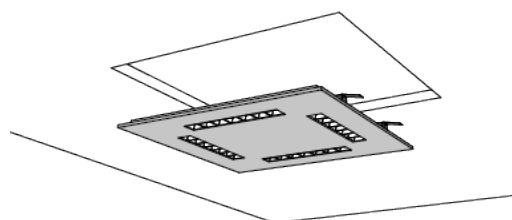

IP40  580mm x 580mm

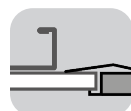

Controsoffitto in cartongesso.
L'installazione dei corpi illuminanti avviene tramite staffe di fissaggio regolabili. Si consiglia la pendinatura di sicurezza al solaio.

*Plasterboard false ceiling.
The installation of the lighting fittings occurs by adjustable fixing brackets. Safe anchoring on the concrete slab recommended.*

CONTROSOFFITTO CLIP-IN Clip-in false ceiling

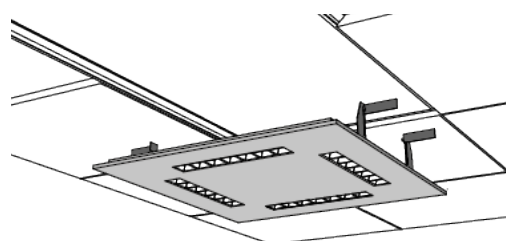

IP40 

Controsoffitto ispezionabile a pannelli modulari con struttura nascosta. L'installazione dei corpi illuminanti avviene in totale integrazione con il controsoffitto grazie ad un kit di montaggio con staffe regolabili in altezza.

Hook-down modular panels false ceiling with clip-in structure. The installation of lighting fittings occurs in a full integration with the false ceiling structure thanks to a mounting kit with height-adjustable brackets.

Adatto per controsoffitti con:
Suitable for false ceiling with:

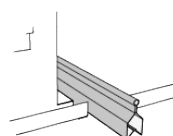

Profilo continentale
Continental profile

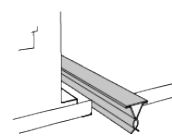

Profilo a triangolo
Triangle profile

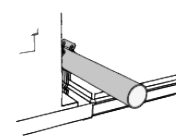

Profilo tubolare
Tube profile
Ø 22mm

Play

OFC

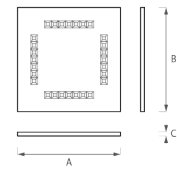
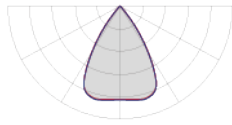

Incasso | Recessed

	Potenza Power [W]	Temp. colore Colour Temp. [K]	IRC CRI	Flusso lum. Lum. flux [lm]	Efficienza lum. Lum. effic. [lm / W]	Dimensioni / Dimensions [mm]			Cod. / Code LED	Cod. / Code LED DALI
						A	B	C		
1x	8	3000	>90	1144	143	595	147.5	23	178800033	178800035
1x	8	4000	>90	1192	149	595	147.5	23	178800034	178800036
1x	16	3000	>90	2288	143	1195	147.5	23	178800041	178800043
1x	16	4000	>90	2384	149	1195	147.5	23	178800042	178800044
2x	16	3000	>90	2288	143	595	595	23	178800001	178800003
2x	16	4000	>90	2384	149	595	595	23	178800002	178800004
2x	16	3000	>90	2288	143	595	295	23	178800049	178800051
2x	16	4000	>90	2384	149	595	295	23	178800050	178800052
2x	32	3000	>90	4576	143	1295	295	23	178800057	178800059
2x	32	4000	>90	4768	149	1295	295	23	178800058	178800060
3x	24	3000	>90	3432	143	595	595	23	178800005	178800007
3x	24	4000	>90	3576	149	595	595	23	178800006	178800008
4x	32	3000	>90	4576	143	595	595	23	178800013	178800015
4x	32	4000	>90	4768	149	595	595	23	178800014	178800016
4x90	32	3000	>90	4576	143	595	595	23	178800009	178800011
4x90	32	4000	>90	4768	149	595	595	23	178800010	178800012

OFC80

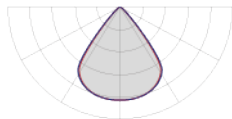

	Potenza Power [W]	Temp. colore Colour Temp. [K]	IRC CRI	Flusso lum. Lum. flux [lm]	Efficienza lum. Lum. effic. [lm / W]	Dimensioni / Dimensions [mm]			Cod. / Code LED	Cod. / Code LED DALI
						A	B	C		
1x	8	3000	>90	1144	143	595	147.5	23	178800037	178800039
1x	8	4000	>90	1192	149	595	147.5	23	178800038	178800040
1x	16	3000	>90	2288	143	1195	147.5	23	178800045	178800047
1x	16	4000	>90	2384	149	1195	147.5	23	178800046	178800048
2x	16	3000	>90	2288	143	595	595	23	178800017	178800019
2x	16	4000	>90	2384	149	595	595	23	178800018	178800020
2x	16	3000	>90	2288	143	595	295	23	178800053	178800055
2x	16	4000	>90	2384	149	595	295	23	178800054	178800056
2x	32	3000	>90	4576	143	1295	295	23	178800061	178800063
2x	32	4000	>90	4768	149	1295	295	23	178800062	178800064
3x	24	3000	>90	3432	143	595	595	23	178800021	178800023
3x	24	4000	>90	3576	149	595	595	23	178800022	178800024
4x	32	3000	>90	4576	143	595	595	23	178800025	178800027
4x	32	4000	>90	4768	149	595	595	23	178800026	178800028
4x90	32	3000	>90	4576	143	595	595	23	178800029	178800031
4x90	32	4000	>90	4768	149	595	595	23	178800030	178800032

Play/N

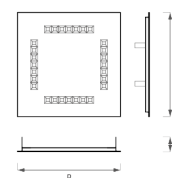

OFC

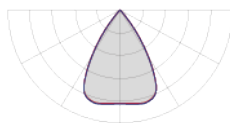

	Potenza Power [W]	Temp. colore Colour Temp. [K]	IRC CRI	Flusso lum. Lum. flux [lm]	Efficienza lum. Lum. effic. [lm / W]	Dimensioni / Dimensions [mm]			Cod. / Code LED	Cod. / Code LED DALI
						A	B	C		
2x	16	3000	>90	2288	143	599	599	100	221200001	221200009
2x	16	4000	>90	2384	149	599	599	100	221200005	221200013
3x	24	3000	>90	3432	143	599	599	100	221200017	221200025
3x	24	4000	>90	3576	149	599	599	100	221200021	221200029
4x	32	3000	>90	4576	143	599	599	100	221200033	221200041
4x	32	4000	>90	4768	149	599	599	100	221200037	221200045
4x90	32	3000	>90	4576	143	599	599	100	221200049	221200057
4x90	32	4000	>90	4768	149	599	599	100	221200053	221200061

OFC80

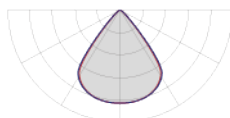

	Potenza Power [W]	Temp. colore Colour Temp. [K]	IRC CRI	Flusso lum. Lum. flux [lm]	Efficienza lum. Lum. effic. [lm / W]	Dimensioni / Dimensions [mm]			Cod. / Code LED	Cod. / Code LED DALI
						A	B	C		
2x	16	3000	>90	2288	143	599	599	100	221200002	221200010
2x	16	4000	>90	2384	149	599	599	100	221200006	221200014
3x	24	3000	>90	3432	143	599	599	100	221200018	221200026
3x	24	4000	>90	3576	149	599	599	100	221200022	221200030
4x	32	3000	>90	4576	143	599	599	100	221200034	221200042
4x	32	4000	>90	4768	149	599	599	100	221200038	221200046
4x90	32	3000	>90	4576	143	599	599	100	221200050	221200058
4x90	32	4000	>90	4768	149	599	599	100	221200054	221200062

1) Il flusso effettivo potrebbe avere una tolleranza del ±10%. / The effective flux could have a tolerance of ±10%.

Plan



Plan

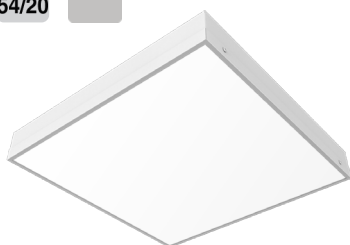

Plan/N

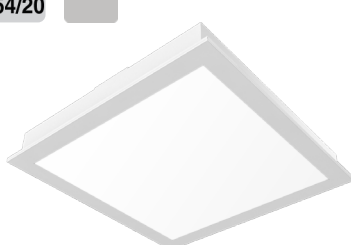

Caratteristiche tecniche

Technical Characteristics

Corpo	Lamiera di acciaio	Body	Sheet-steel
Colore	<ul style="list-style-type: none"> ○ Bianco opaco (RAL 9003) Su richiesta: <ul style="list-style-type: none"> ● Altri colori 	Colour	<ul style="list-style-type: none"> ○ Matt white (RAL 9003) On request: <ul style="list-style-type: none"> ● Other colours available
Gruppo ottico	<ul style="list-style-type: none"> · PSU - polistirene microprismatico (UGR<19) · MOT - metacrilato opale 	Optical group	<ul style="list-style-type: none"> · PSU - microprismatic polystyrene (UGR<19) · MOT - opal methacrylate
Cablaggio	<ul style="list-style-type: none"> · LED ON/OFF con driver integrato · LED DALI con driver integrato Su richiesta: <ul style="list-style-type: none"> · Circuito RGB DMX · Kit di EMERGENZA (autonomia 1/3 h) 	Wiring	<ul style="list-style-type: none"> · LED ON/OFF with integrated driver · LED DALI with integrated driver On request: <ul style="list-style-type: none"> · DMX RGB Circuit · EMERGENCY kit (1/3 h autonomy)
Grado di protezione	<ul style="list-style-type: none"> · IP 54/20 	Protection degree	<ul style="list-style-type: none"> · IP 54/20

Sorgenti LED

LED sources

IRC	<ul style="list-style-type: none"> · >80 Su richiesta: <ul style="list-style-type: none"> · >90 	CRI	<ul style="list-style-type: none"> · >80 On request: <ul style="list-style-type: none"> · >90
Temp. colore	<ul style="list-style-type: none"> · 3000 K · 4000 K Su richiesta: <ul style="list-style-type: none"> · TUNABLE WHITE 2700-6500 K · LED RGB 	Colour Temp.	<ul style="list-style-type: none"> · 3000 K · 4000 K On request: <ul style="list-style-type: none"> · TUNABLE WHITE 2700-6500 K · RGB LED

Gruppi ottici

Optical groups

PSU

Diffusore in polistirene microprismatico anabbagliante ad emissione luminosa controllata. Conforme ad essere installata in ambienti con uso di videotermini secondo la norma UNI EN 12464-1.

Diffuser made of anti-glare microprismatic polystyrene with controlled luminance emission. Suitable for installation in workplaces with the use of video terminals according to EN 12464-1 standard.

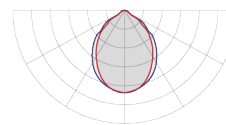

UGR <19

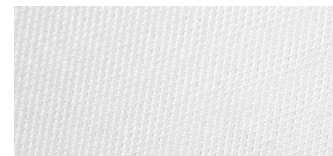

MOT

Diffusore in metacrilato opale ad alta trasmittanza, ideale per una distribuzione uniforme.

Diffuser in opal methacrylate with high transmittance, ideal for uniform distribution.

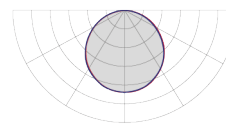

Plan/D1

Su richiesta / On request



Plan/EASY LINE

Su richiesta / On request

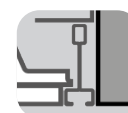

Plan/T

Su richiesta / On request



Plan/G

Su richiesta / On request

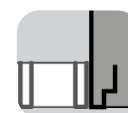
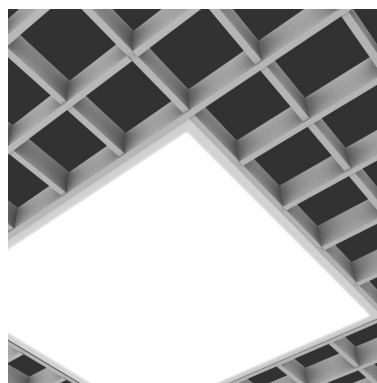

Plan



Incasso | Recessed

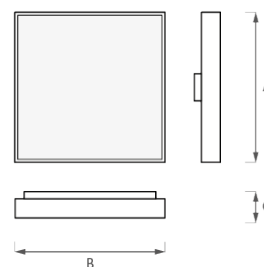
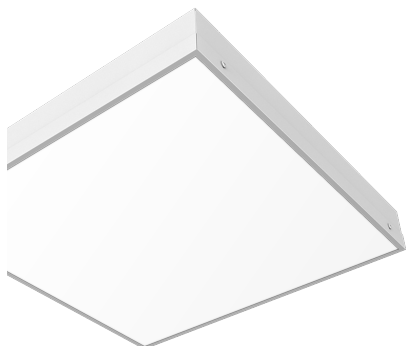

Dimensioni/Dimensions[mm]

A	B	C
597	597	108
297	1197	108

Tipologia di installazione Type of installation

CONTROSOFFITTO LAY-IN Lay-in false ceiling

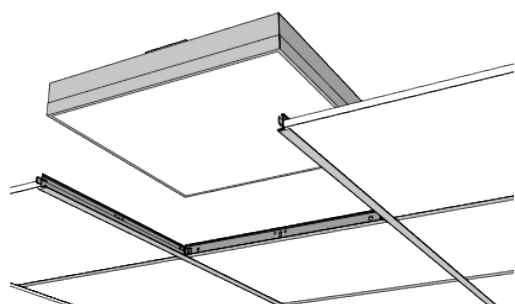

IP
54/20



Controsoffitto con struttura a vista. L'installazione dei corpi illuminanti avviene direttamente in appoggio alla struttura portante con profilo a "T", senza staffe di fissaggio. Si consiglia la pendinatura di sicurezza al solai.

False ceiling with lay-in structure. The installation of lighting fittings occurs directly on the structure with "T" profile. Safe anchoring on the concrete slab recommended.

Versioni
Versions

Plan/N

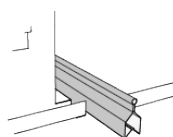
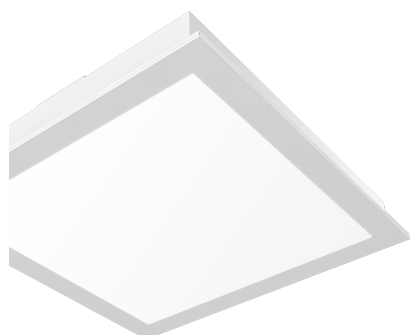

Profilo continentale
Continental profile

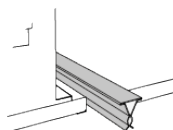

Profilo a triangolo
Triangle profile

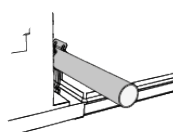

Profilo tubolare
Tube profile
Ø 22mm

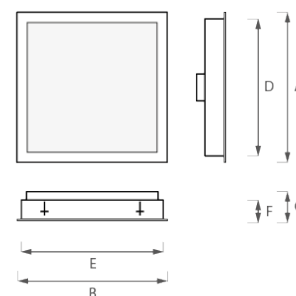

Dimensioni / Dimensions [mm]					
A	B	C	D	E	F
600	600	106	550	570	82
300	1200	106	250	1170	82

Tipologia di installazione

Type of installation

CARTONGESSO

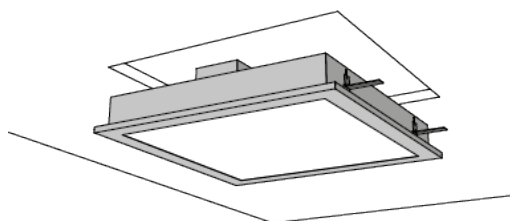
Plasterboard

580mm x 580mm
280mm x 1180mm
580mm x 1180mm

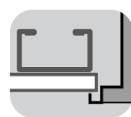

Controsoffitto in cartongesso.
L'installazione dei corpi illuminanti avviene tramite staffe di fissaggio regolabili. Si consiglia la pendinatura di sicurezza al solaio.

*Plasterboard false ceiling.
The installation of the lighting fittings occurs by adjustable fixing brackets. Safe anchoring on the concrete slab recommended.*

CONTROSOFFITTO CLIP-IN A TENUTA

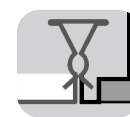
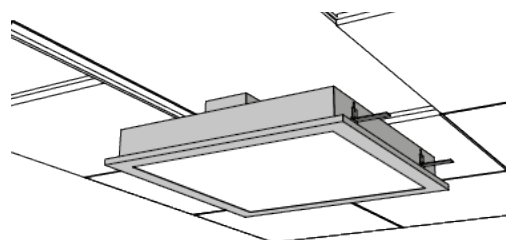
Clip-in false ceiling concealed structure

Controsoffitto ispezionabile a pannelli modulari con struttura nascosta. L'installazione dei corpi illuminanti avviene in totale integrazione con il controsoffitto grazie ad un kit di montaggio con staffe regolabili in altezza.

Hook-down modular panels false ceiling with clip-in structure. The installation of lighting fittings occurs in a full integration with the false ceiling structure thanks to a mounting kit with height-adjustable brackets.

Adatto per controsoffitti con:
Suitable for false ceiling with:

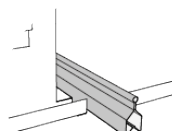

Profilo continentale
Continental profile

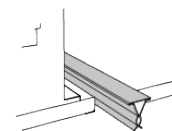

Profilo a triangolo
Triangle profile

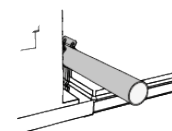

Profilo tubolare
Tube profile
Ø 22mm

Plan

PSU

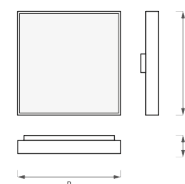
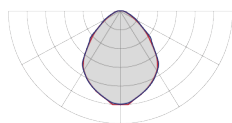

Incasso | Recessed

Potenza Power [W]	Temp. colore Colour Temp. [K]	IRC CRI	Flusso lum. Lum. flux [lm]	Efficienza lum. Lum. effic. [lm / W]	Dimensioni / Dimensions [mm]			Cod. / Code LED	Cod. / Code LED DALI
					A	B	C		
26	3000	>80	3328	128	597	597	108	178400301	178400306
26	4000	>80	3510	135	597	597	108	178400291	178400296
32	3000	>80	4096	128	597	597	108	178400302	178400307
32	4000	>80	4320	135	597	597	108	178400292	178400297
38	3000	>80	4864	128	597	597	108	178400303	178400308
38	4000	>80	5130	135	597	597	108	178400293	178400298
44	3000	>80	5632	128	597	597	108	178400304	178400309
44	4000	>80	5940	135	597	597	108	178400294	178400299
50	3000	>80	6400	128	597	597	108	178400305	178400310
50	4000	>80	6750	135	597	597	108	178400295	178400300
38	3000	>80	4864	128	297	1197	108	178400323	178400326
38	4000	>80	5130	135	297	1197	108	178400329	178400332
44	3000	>80	5632	128	297	1197	108	178400324	178400327
44	4000	>80	5940	135	297	1197	108	178400330	178400333
50	3000	>80	6400	128	297	1197	108	178400325	178400328
50	4000	>80	6750	135	297	1197	108	178400331	178400334

MOT

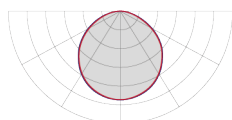

Potenza Power [W]	Temp. colore Colour Temp. [K]	IRC CRI	Flusso lum. Lum. flux [lm]	Efficienza lum. Lum. effic. [lm / W]	Dimensioni / Dimensions [mm]			Cod. / Code LED	Cod. / Code LED DALI
					A	B	C		
26	3000	>80	3016	116	597	597	108	178400281	178400286
26	4000	>80	3172	122	597	597	108	178400271	178400276
32	3000	>80	3712	116	597	597	108	178400282	178400287
32	4000	>80	3904	122	597	597	108	178400272	178400277
38	3000	>80	4408	116	597	597	108	178400283	178400288
38	4000	>80	4636	122	597	597	108	178400273	178400278
44	3000	>80	5104	116	597	597	108	178400284	178400289
44	4000	>80	5368	122	597	597	108	178400274	178400279
50	3000	>80	5800	116	597	597	108	178400285	178400290
50	4000	>80	6100	122	597	597	108	178400275	178400280
38	3000	>80	4408	116	297	1197	108	178400311	178400314
38	4000	>80	4636	122	297	1197	108	178400317	178400320
44	3000	>80	5104	116	297	1197	108	178400312	178400315
44	4000	>80	5368	122	297	1197	108	178400318	178400321
50	3000	>80	5800	116	297	1197	108	178400313	178400316
50	4000	>80	6100	122	297	1197	108	178400319	178400322

Plan/N

PSU

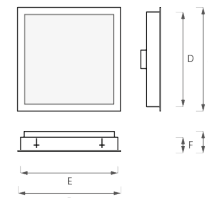
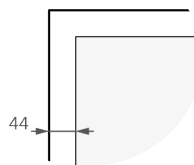
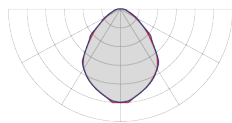

Potenza Power [W]	Temp. colore Colour Temp. [K]	IRC CRI	Flusso lum. Lum. flux [lm]	Efficienza lum. Lum. effic. [lm / W]	Dimensioni / Dimensions [mm]								Cod./ Code LED	Cod./ Code LED DALI
					A	B	C	D	E	F				
26	3000	>80	3328	128	600	600	106	550	570	82	580x580	227000100	227000105	
26	4000	>80	3510	135	600	600	106	550	570	82	580x580	227000110	227000115	
32	3000	>80	4096	128	600	600	106	550	570	82	580x580	227000101	227000106	
32	4000	>80	4320	135	600	600	106	550	570	82	580x580	227000111	227000116	
38	3000	>80	4864	128	600	600	106	550	570	82	580x580	227000102	227000107	
38	4000	>80	5130	135	600	600	106	550	570	82	580x580	227000112	227000117	
44	3000	>80	5632	128	600	600	106	550	570	82	580x580	227000103	227000108	
44	4000	>80	5940	135	600	600	106	550	570	82	580x580	227000113	227000118	
50	3000	>80	6400	128	600	600	106	550	570	82	580x580	227000104	227000109	
50	4000	>80	6750	135	600	600	106	550	570	82	580x580	227000114	227000119	
38	3000	>80	4864	128	300	1200	106	250	1170	82	280x1180	227000120	227000123	
38	4000	>80	5130	135	300	1200	106	250	1170	82	280x1180	227000126	227000129	
44	3000	>80	5632	128	300	1200	106	250	1170	82	280x1180	227000121	227000124	
44	4000	>80	5940	135	300	1200	106	250	1170	82	280x1180	227000127	227000130	
50	3000	>80	6400	128	300	1200	106	250	1170	82	280x1180	227000122	227000125	
50	4000	>80	6750	135	300	1200	106	250	1170	82	280x1180	227000128	227000131	

MOT

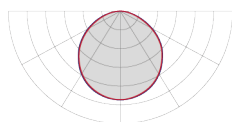

Potenza Power [W]	Temp. colore Colour Temp. [K]	IRC CRI	Flusso lum. Lum. flux [lm]	Efficienza lum. Lum. effic. [lm / W]	Dimensioni / Dimensions [mm]								Cod./ Code LED	Cod./ Code LED DALI
					A	B	C	D	E	F				
26	3000	>80	3016	116	600	600	106	550	570	82	580x580	227000132	227000137	
26	4000	>80	3172	122	600	600	106	550	570	82	580x580	227000142	227000147	
32	3000	>80	3712	116	600	600	106	550	570	82	580x580	227000133	227000138	
32	4000	>80	3904	122	600	600	106	550	570	82	580x580	227000143	227000148	
38	3000	>80	4408	116	600	600	106	550	570	82	580x580	227000134	227000139	
38	4000	>80	4636	122	600	600	106	550	570	82	580x580	227000144	227000149	
44	3000	>80	5104	116	600	600	106	550	570	82	580x580	227000135	227000140	
44	4000	>80	5368	122	600	600	106	550	570	82	580x580	227000145	227000150	
50	3000	>80	5800	116	600	600	106	550	570	82	580x580	227000136	227000141	
50	4000	>80	6100	122	600	600	106	550	570	82	580x580	227000146	227000151	
38	3000	>80	4408	116	300	1200	106	250	1170	82	280x1180	227000152	227000155	
38	4000	>80	4636	122	300	1200	106	250	1170	82	280x1180	227000158	227000161	
44	3000	>80	5104	116	300	1200	106	250	1170	82	280x1180	227000153	227000156	
44	4000	>80	5368	122	300	1200	106	250	1170	82	280x1180	227000159	227000162	
50	3000	>80	5800	116	300	1200	106	250	1170	82	280x1180	227000154	227000157	
50	4000	>80	6100	122	300	1200	106	250	1170	82	280x1180	227000160	227000163	

1) Il flusso effettivo potrebbe avere una tolleranza del ±10%. / The effective flux could have a tolerance of ±10%.

Round About



Caratteristiche tecniche

Technical Characteristics

Corpo	Lamiera di acciaio	Body	Sheet-steel
Colore	○ Bianco Opaco (RAL9003) <u>Su richiesta:</u> ● Altri colori	Colour	○ Matt white (RAL9003) <u>On request:</u> ● Other colours available
Gruppo ottico	· PSU - polistirene microprismatico (UGR<19) · MOT - metacrilato opale	Optical group	· PSU - microprismatic polystyrene (UGR<19) · MOT - opal methacrylate
Cablaggio	· LED ON/OFF con driver integrato · LED DALI con driver integrato <u>Su richiesta:</u> · Kit di EMERGENZA (autonomia 1/3 h)	Wiring	· LED ON/OFF with integrated driver · LED DALI with integrated driver <u>On request:</u> · EMERGENCY kit (1/3 h autonomy)
Grado di protezione	· IP 54/20	Protection degree	· IP 54/20

Sorgenti LED

LED sources

IRC	· >80 <u>Su richiesta:</u> · >90	CRI	· >80 <u>On request:</u> · >90
Temp. colore	· 3000 K · 4000 K <u>Su richiesta:</u> · TUNABLE WHITE 2700-6500 K	Colour Temp.	· 3000 K · 4000 K <u>On request:</u> · TUNABLE WHITE 2700-6500 K

Gruppi ottici

Optical groups

PSU

Diffusore in polistirene microprismatico anabbagliante ad emissione luminosa controllata. Conforme ad essere installata in ambienti con uso di videotermini secondo la norma UNI EN 12464-1.

Diffuser made of anti-glare microprismatic polystyrene with controlled luminance emission. Suitable for installation in workplaces with the use of video terminals according to EN 12464-1 standard.

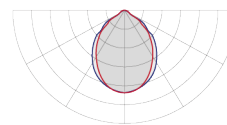

UGR <19

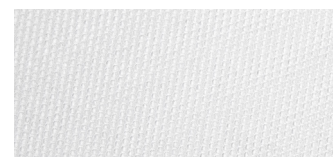

MOT

Diffusore in metacrilato opale ad alta trasmittanza, ideale per una distribuzione uniforme.

Diffuser in opal methacrylate with high transmittance, ideal for uniform distribution.

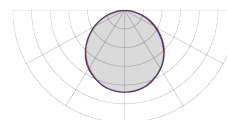

Tipologia di installazione

Type of installation

CARTONGESSO

Plasterboard



Controsoffitto in cartongesso. L'installazione dei corpi illuminanti avviene tramite staffe di fissaggio regolabili. Si consiglia la pendinatura di sicurezza al solaio.

Plasterboard false ceiling. The installation of the lighting fittings occurs by adjustable fixing brackets. Safe anchoring on the concrete slab recommended.

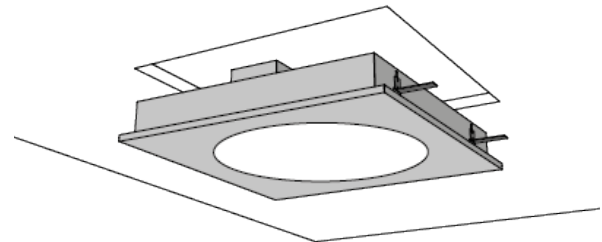

580mm x 580mm



CONTROSOFFITTO LAY-IN

Lay-in false ceiling



Controsoffitto con struttura a vista. L'installazione dei corpi illuminanti avviene direttamente in appoggio alla struttura portante con profilo a "T", senza staffe di fissaggio. Si consiglia la pendinatura di sicurezza al solaio.

False ceiling with lay-in structure. The installation of lighting fittings occurs directly on the structure with "T" profile. Safe anchoring on the concrete slab recommended.

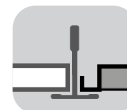
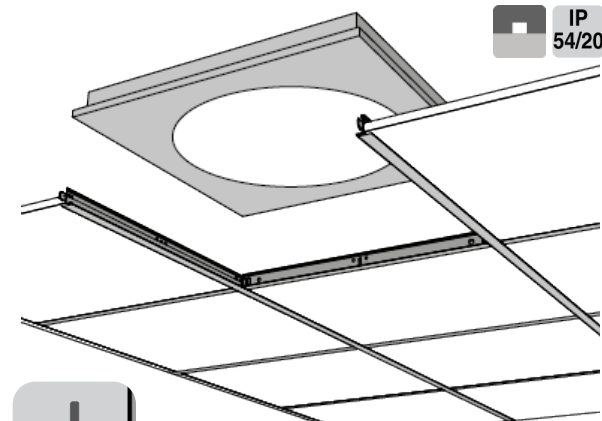

CONTROSOFFITTO CLIP-IN

Clip-in false ceiling



Controsoffitto ispezionabile a pannelli modulari con struttura nascosta. L'installazione dei corpi illuminanti avviene in totale integrazione con il controsoffitto grazie ad un kit di montaggio con staffe regolabili in altezza.

Hook-down modular panels false ceiling with clip-in structure. The installation of lighting fittings occurs in a full integration with the false ceiling structure thanks to a mounting kit with height-adjustable brackets.

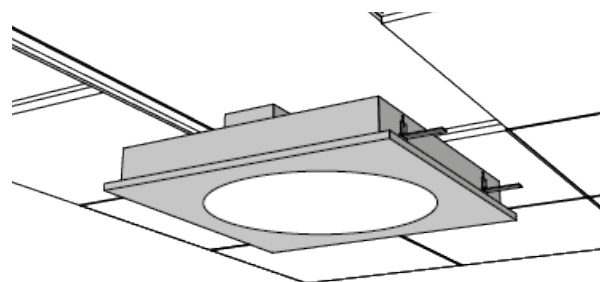

Adatto per controsoffitti con:
Suitable for false ceiling with:

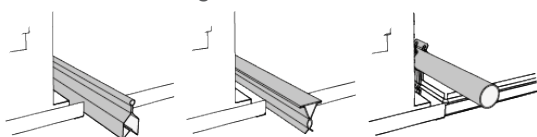

Profilo continentale
Continental profile

Profilo a triangolo
Triangle profile

Profilo tubolare
Tube profile
Ø 22mm

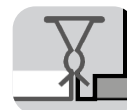

Round About/T

Su richiesta / On request

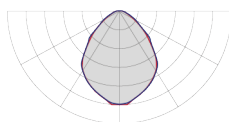
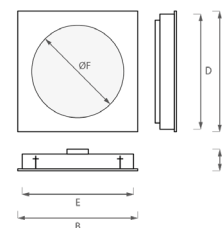
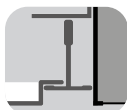

PSU



Potenza Power [W]	Temp. colore Colour Temp. [K]	IRC CRI	Flusso lum. Lum. flux [lm]	Efficienza lum. Lum. effic. [lm / W]	Dimensioni / Dimensions [mm]						Cod. / Code LED	Cod. / Code LED DALI
					A	B	C	D	E	Ø F		
32	3000	>80	3296	103	596	596	106	570	546	460	178000113	178000117
32	4000	>80	3488	109	596	596	106	570	546	460	178000121	178000125
38	3000	>80	3914	103	596	596	106	570	546	460	178000114	178000118
38	4000	>80	4142	109	596	596	106	570	546	460	178000122	178000126
44	3000	>80	4532	103	596	596	106	570	546	460	178000115	178000119
44	4000	>80	4796	109	596	596	106	570	546	460	178000123	178000127
50	3000	>80	5150	103	596	596	106	570	546	460	178000116	178000120
50	4000	>80	5450	109	596	596	106	570	546	460	178000124	178000128

MOT

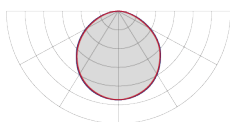

Potenza Power [W]	Temp. colore Colour Temp. [K]	IRC CRI	Flusso lum. Lum. flux [lm]	Efficienza lum. Lum. effic. [lm / W]	Dimensioni / Dimensions [mm]						Cod. / Code LED	Cod. / Code LED DALI
					A	B	C	D	E	Ø F		
32	3000	>80	2976	93	596	596	106	570	546	460	178000083	178000087
32	4000	>80	3136	98	596	596	106	570	546	460	178000091	178000094
38	3000	>80	3534	93	596	596	106	570	546	460	178000084	178000088
38	4000	>80	3724	98	596	596	106	570	546	460	178000092	178000095
44	3000	>80	4092	93	596	596	106	570	546	460	178000085	178000089
44	4000	>80	4312	98	596	596	106	570	546	460	178000082	178000096
50	3000	>80	4650	93	596	596	106	570	546	460	178000086	178000090
50	4000	>80	4900	98	596	596	106	570	546	460	178000093	178000097

Maggiori informazioni sui controsoffitti a pag. 74-77 / More information regarding false ceiling on page 74-77
 I) Il flusso effettivo potrebbe avere una tolleranza del ±10%. / The effective flux could have a tolerance of ±10%.

Manta

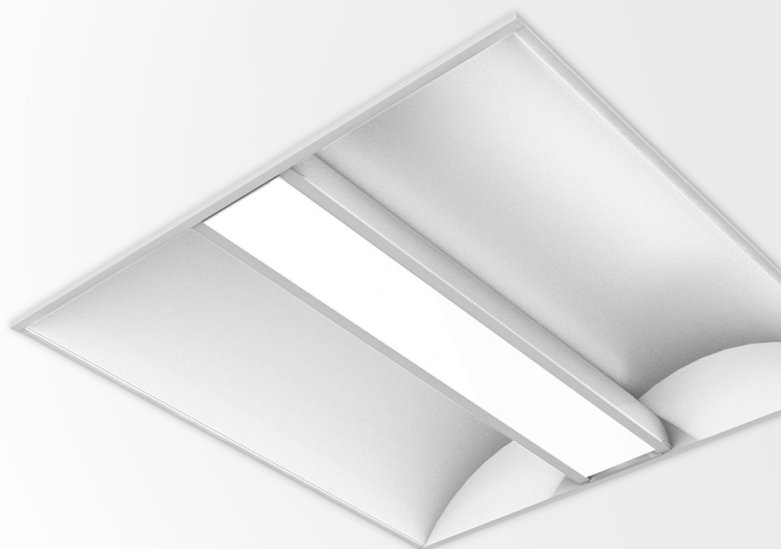

Caratteristiche tecniche

Technical Characteristics

Corpo	Lamiera di acciaio	Body	Sheet-steel
Colore	<ul style="list-style-type: none"> ○ Bianco opaco (RAL 9003) <u>Su richiesta:</u> ● Altri colori 	Colour	<ul style="list-style-type: none"> ○ Matt white (RAL 9003) <u>On request:</u> ● Other colours available
Gruppo ottico	<ul style="list-style-type: none"> · PMO - policarbonato microprismatico (UGR<19) 	Optical group	<ul style="list-style-type: none"> · PMO - microprismatic polycarbonate (UGR<19)
Cablaggio	<ul style="list-style-type: none"> · LED ON/OFF con driver integrato · LED DALI con driver integrato <u>Su richiesta:</u> · Kit di EMERGENZA (autonomia 1/3 h) 	Wiring	<ul style="list-style-type: none"> · LED ON/OFF with integrated driver · LED DALI with integrated driver <u>On request:</u> · EMERGENCY kit (1/3 h autonomy)
Grado di protezione	<ul style="list-style-type: none"> · IP 40/20 	Protection degree	<ul style="list-style-type: none"> · IP 40/20

Sorgenti LED

LED sources

IRC	<ul style="list-style-type: none"> · >80 <u>Su richiesta:</u> · >90 	CRI	<ul style="list-style-type: none"> · >80 <u>On request:</u> · >90
Temp. colore	<ul style="list-style-type: none"> · 3000 K · 4000 K <u>Su richiesta:</u> · TUNABLE WHITE 2700-6500 K 	Colour Temp.	<ul style="list-style-type: none"> · 3000 K · 4000 K <u>On request:</u> · TUNABLE WHITE 2700-6500 K

Gruppi ottici

Optical groups

PMO

Diffusore in policarbonato microprismatico anabbagliante. Valori di luminanza < 3000 cd/m² per angoli > 65°. Film interno in policarbonato opale anabbagliante per una maggiore uniformità luminosa. Conforme ad essere installata in ambienti con uso di videotermini secondo la norma UNI EN 12464-1.

Diffuser made of anti-glare microprismatic polycarbonate. Luminance values <3000 cd/m² for angles >65°. Internal anti-glare opal polycarbonate film for a better light uniformity. Suitable for installation in workplaces with the use of video terminals according to EN 12464-1 standard.

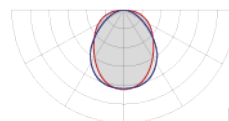

UGR <19

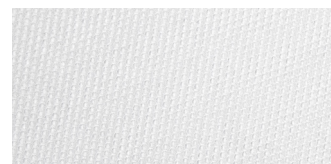

Tipologia di installazione

Type of installation

CARTONGESSO

Plasterboard



Controsoffitto in cartongesso.

L'installazione dei corpi illuminanti avviene tramite staffe di fissaggio regolabili. Si consiglia la pendinatura di sicurezza al solaio.

Plasterboard false ceiling.

The installation of the lighting fittings occurs by adjustable fixing brackets. Safe anchoring on the concrete slab recommended.

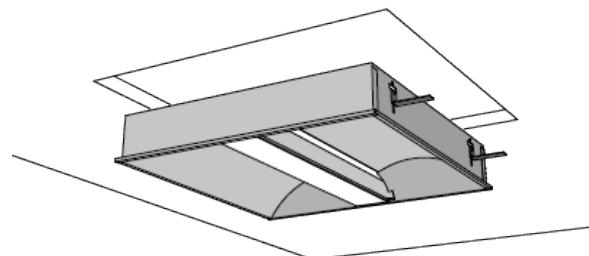

582mm x 582mm
282mm x 1182mm

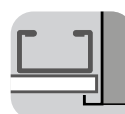

CONTROSOFFITTO LAY-IN

Lay-in false ceiling



Controsoffitto con struttura a vista. L'installazione dei corpi illuminanti avviene direttamente in appoggio alla struttura portante con profilo a "T", senza staffe di fissaggio. Si consiglia la pendinatura di sicurezza al solaio.

False ceiling with lay-in structure. The installation of lighting fittings occurs directly on the structure with "T" profile. Safe anchoring on the concrete slab recommended.

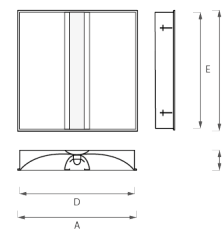
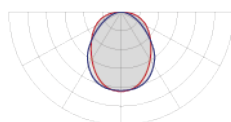
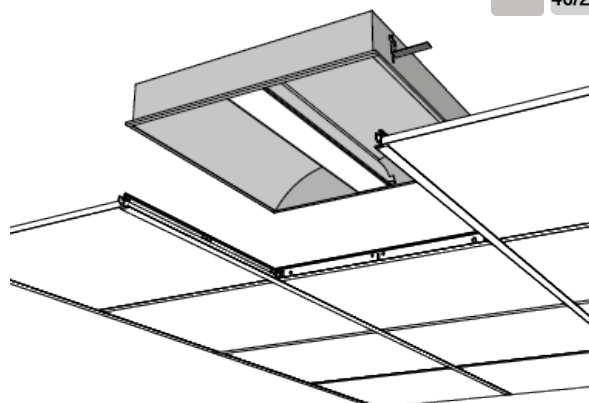

PMO



Potenza Power [W]	Temp. colore Colour Temp. [K]	IRC CRI	Flusso lum. Lum. flux [lm]	Efficienza lum. Lum. effic. [lm / W]	Dimensioni / Dimensions [mm]					Cod. / Code LED	Cod. / Code LED DALI
					A	B	C	D	E		
42	3000	>80	3570	85	595	595	100	580	580	147100121	147100122
42	4000	>80	3906	93	595	595	100	580	580	147100135	147100136
50	3000	>80	4250	85	595	595	100	580	580	147100123	147100124
50	4000	>80	4650	93	595	595	100	580	580	147100125	147100126
64	3000	>80	5440	85	595	595	100	580	580	147100127	147100128
64	4000	>80	5952	93	595	595	100	580	580	147100129	147100130
63	3000	>80	5355	85	295	1195	100	280	1180	147100131	147100132
63	4000	>80	5859	93	295	1195	100	280	1180	147100133	147100134

Maggiori informazioni sui controsoffitti a pag. 74-77 / More information regarding false ceiling on page 74-77
 I) Il flusso effettivo potrebbe avere una tolleranza del ±10%. / The effective flux could have a tolerance of ±10%.

Slim

IP 40/20 UGR <19

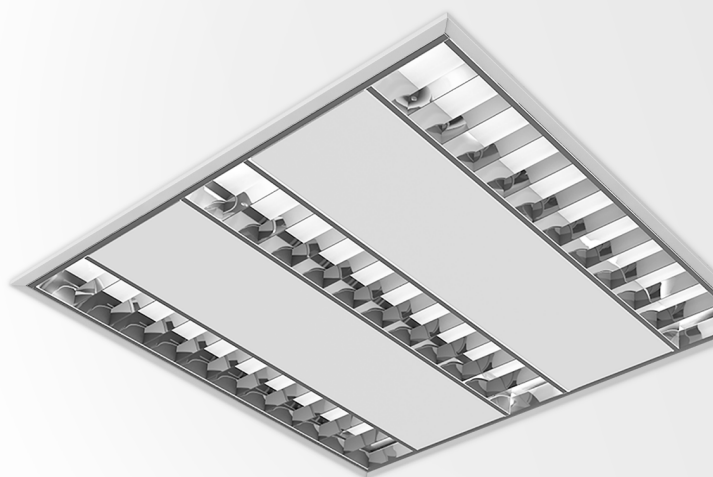

2x

IP 40/20



3x

IP 40/20

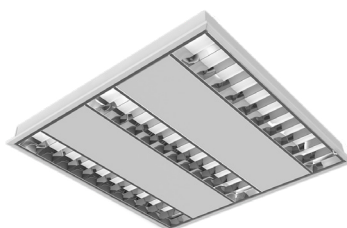

Caratteristiche tecniche

Technical Characteristics

Corpo	Lamiera di acciaio	Body	Sheet-steel
Colore	<ul style="list-style-type: none"> ○ Bianco opaco (RAL9003) <u>Su richiesta:</u> ● Altri colori 	Colour	<ul style="list-style-type: none"> ○ Matt white (RAL9003) <u>On request:</u> ● Other colours available
Gruppo ottico	· DLM - darklight (UGR<19)	Optical group	· DLM - darklight (UGR<19)
Cablaggio	<ul style="list-style-type: none"> · LED ON/OFF con driver integrato · LED DALI con driver integrato <u>Su richiesta:</u> · Kit di EMERGENZA (autonomia 1/3 h) 	Wiring	<ul style="list-style-type: none"> · LED ON/OFF with integrated driver · LED DALI with integrated driver <u>On request:</u> · EMERGENCY kit (1/3 h autonomy)
Grado di protezione	· IP 40/20	Protection degree	· IP 40/20

Sorgenti LED

LED sources

IRC	<ul style="list-style-type: none"> >80 <u>Su richiesta:</u> >90 	CRI	<ul style="list-style-type: none"> >80 <u>On request:</u> >90
Temp. colore	<ul style="list-style-type: none"> · 3000 K · 4000 K <u>Su richiesta:</u> · TUNABLE WHITE 2700-6500 K 	Colour Temp.	<ul style="list-style-type: none"> · 3000 K · 4000 K <u>On request:</u> · TUNABLE WHITE 2700-6500 K

Gruppi ottici

Optical groups

DLM

Ottica darklight in alluminio speculare ad emissione "batwing". Valori di luminanza <math><1000\text{ cd/m}^2</math> per angoli >math>65^\circ</math>. Film interno in policarbonato opale anabbagliante per una maggiore uniformità luminosa. Conforme ad essere installata in ambienti con uso di videoterminali secondo la norma UNI EN 12464-1.

Darklight specular aluminium diffuser with "batwing" emission. Luminance values <math><1000\text{ cd/m}^2</math> for angles >math>65^\circ</math>. Internal anti-glare opal polycarbonate film for a better light uniformity. Suitable for installation in workplaces with the use of video terminals according to EN 12464-1 standard.

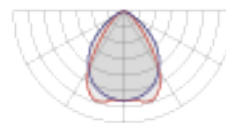

UGR
<math><19</math>



Tipologia di installazione

Type of installation

CARTONGESSO

Plasterboard



Controsoffitto in cartongesso. L'installazione dei corpi illuminanti avviene tramite staffe di fissaggio regolabili. Si consiglia la pendinatura di sicurezza al solaio.

Plasterboard false ceiling. The installation of the lighting fittings occurs by adjustable fixing brackets. Safe anchoring on the concrete slab recommended.

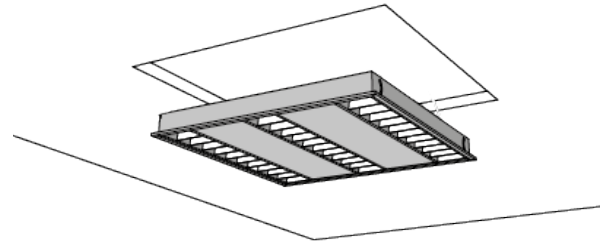

Accessori (da ordinare separatamente)
Accessories (to be ordered separately)



4 pcs. kit

STAFFE DI FISSAGGIO
FIXING BRACKETS

Cod. / Code KCS167000

Staffe in acciaio zincato. Viteria inclusa.
Galvanized steel union bracket.
Fixing screws included.



580mm x 580mm

CONTROSOFFITTO LAY-IN

Lay-in false ceiling



Controsoffitto con struttura a vista. L'installazione dei corpi illuminanti avviene direttamente in appoggio alla struttura portante con profilo a "T", senza staffe di fissaggio. Si consiglia la pendinatura di sicurezza al solaio.

False ceiling with lay-in structure. The installation of lighting fittings occurs directly on the structure with "T" profile. Safe anchoring on the concrete slab recommended.

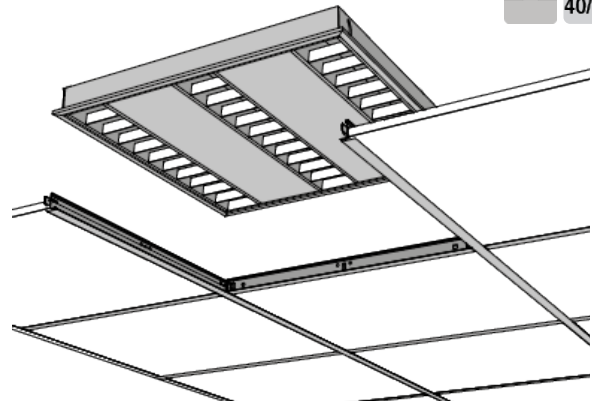

CONTROSOFFITTO CLIP-IN

Clip-in false ceiling



Controsoffitto ispezionabile a pannelli modulari con struttura nascosta. L'installazione dei corpi illuminanti avviene in totale integrazione con il controsoffitto grazie ad un kit di montaggio con staffe regolabili in altezza.

Hook-down modular panels false ceiling with clip-in structure. The installation of lighting fittings occurs in a full integration with the false ceiling structure thanks to a mounting kit with height-adjustable brackets.

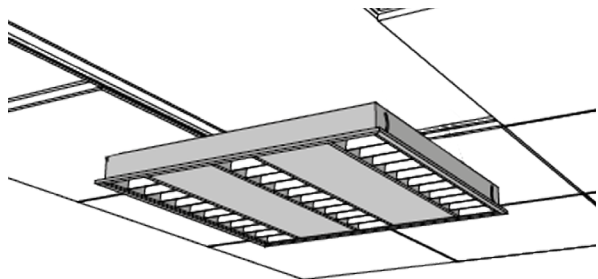

Accessori (da ordinare separatamente)
Accessories (to be ordered separately)



4 pcs. kit

STAFFE DI FISSAGGIO
FIXING BRACKETS

Cod. / Code KCS167000

Staffe in acciaio zincato. Viteria inclusa.
Galvanized steel union bracket.
Fixing screws included.



Slim/D1

Su richiesta / On request

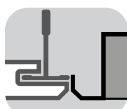

Slim/EASY LINE

Su richiesta / On request

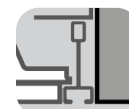

2x

3x

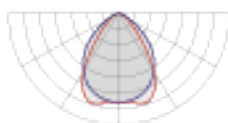
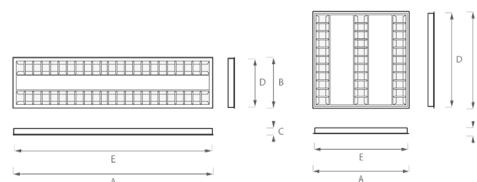

DLM



	Potenza Power [W]	Temp. colore Colour Temp. [K]	IRC CRI	Flusso lum. Lum. flux [lm]	Efficienza lum. Lum. effic. [lm / W]	Dimensioni/Dimensions [mm]					Cod. / Code LED	Cod. / Code LED DALI
						A	B	C	D	E		
2x	30	3000	>80	3420	114	1196	296	52	272	1172	167000212	167000213
2x	30	4000	>80	3690	123	1196	296	52	272	1172	167000223	167000214
2x	41	3000	>80	4674	114	1196	296	52	272	1172	167000215	167000216
2x	41	4000	>80	5043	123	1196	296	52	272	1172	167000217	167000218
2x	52	3000	>80	5928	114	1196	296	52	272	1172	167000219	167000220
2x	52	4000	>80	6396	123	1196	296	52	272	1172	167000221	167000222
3x	31	3000	>80	3534	114	596	596	52	572	572	167000200	167000201
3x	31	4000	>80	3813	123	596	596	52	572	572	167000202	167000203
3x	39	3000	>80	4446	114	596	596	52	572	572	167000204	167000205
3x	39	4000	>80	4797	123	596	596	52	572	572	167000206	167000207
3x	54	3000	>80	6156	114	596	596	52	572	572	167000208	167000209
3x	54	4000	>80	6642	123	596	596	52	572	572	167000210	167000211

Maggiori informazioni sui controsoffitti a pag. 74-77 / More information regarding false ceiling on page 74-77
 I) Il flusso effettivo potrebbe avere una tolleranza del ±10%. / The effective flux could have a tolerance of ±10%.



AT/Fire

Incasso | Recessed

Apparecchio **certificato REI 120**, idoneo per essere installato in compartimenti antincendio di Classe REI 120.

REI 120 certified apparatus, suitable for installation on REI 120 fireproof compartments.

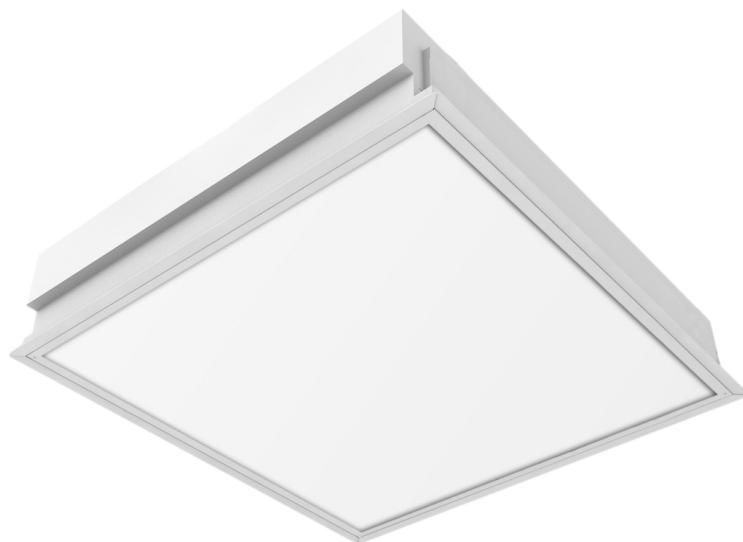

Caratteristiche tecniche

Technical Characteristics

Corpo	<ul style="list-style-type: none"> • Doppio corpo metallico in lamiera di acciaio (10/10); • Intercapedine superiore riempita con materassino compresso in fibra ceramica e intercapedini laterali coibentate con pannello in fibra minerale; • Profilo perimetrale provvisto di guarnizioni in carta ceramica ecologica, non cancerogena. 	Body	<ul style="list-style-type: none"> • Double metal body in sheet-steel (10/10); • Upper air space filled with a ceramic fibre mattress and lateral air space insulated with mineral fibre panel; • Perimetrical profile furnished with a gasket in ecologic ceramic paper, that is not carcinogenic.
Colore	○ Bianco opaco (RAL 9003)	Colour	○ Matt white (RAL 9003)
Gruppo ottico	<ul style="list-style-type: none"> • PMO - policarbonato microprismatico (UGR<19) • MOT - metacrilato opale 	Optical group	<ul style="list-style-type: none"> • PMO - microprismatic polycarbonate (UGR<19) • MOT - opal methacrylate
Cablaggio	<ul style="list-style-type: none"> • LED ON/OFF con driver integrato • LED DALI con driver integrato <p><u>Su richiesta:</u></p> <ul style="list-style-type: none"> • Kit di EMERGENZA (autonomia 1/3 h) 	Wiring	<ul style="list-style-type: none"> • LED ON/OFF with integrated driver • LED DALI with integrated driver <p><u>On request:</u></p> <ul style="list-style-type: none"> • EMERGENCY kit (1/3 h autonomy)
Grado di protezione	<ul style="list-style-type: none"> • IP 40 • REI 120 	Protection degree	<ul style="list-style-type: none"> • IP 40 • REI 120

Sorgenti LED

LED sources

IRC	<ul style="list-style-type: none"> • >80 <p><u>Su richiesta:</u></p> <ul style="list-style-type: none"> • >90 	CRI	<ul style="list-style-type: none"> • >80 <p><u>On request:</u></p> <ul style="list-style-type: none"> • >90
Temp. colore	<ul style="list-style-type: none"> • 3000 K • 4000 K <p><u>Su richiesta:</u></p> <ul style="list-style-type: none"> • TUNABLE WHITE 2700-6500 K 	Colour Temp.	<ul style="list-style-type: none"> • 3000 K • 4000 K <p><u>On request:</u></p> <ul style="list-style-type: none"> • TUNABLE WHITE 2700-6500 K

Gruppi ottici

Optical groups

PMO

Diffusore in policarbonato microprismatico anabbagliante. Valori di luminanza <math> < 3000 \text{ cd/m}^2 </math> per angoli > 65°. Film interno in policarbonato opale anabbagliante per una maggiore uniformità luminosa. Conforme ad essere installata in ambienti con uso di videoterminali secondo la norma UNI EN 12464-1.

Diffuser made of anti-glare microprismatic polycarbonate. Luminance values <math> < 3000 \text{ cd/m}^2 </math> for angles >65°. Internal anti-glare opal polycarbonate film for a better light uniformity. Suitable for installation in workplaces with the use of video terminals according to EN 12464-1 standard.

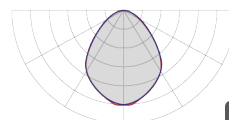

UGR <19

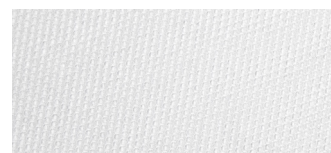

MOT

Diffusore in metacrilato opale ad alta trasmittanza, ideale per una distribuzione uniforme.

Diffuser in opal methacrylate with high transmittance, ideal for uniform distribution.

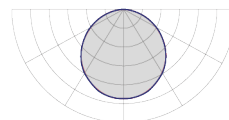

Tipologia di installazione

Type of installation

CONTROSOFFITTO LAY-IN

Lay-in false ceiling

Controsoffitto con struttura a vista. L'installazione dei corpi illuminanti avviene direttamente in appoggio alla struttura portante con profilo a "T", senza staffe di fissaggio. Si consiglia la pendinatura di sicurezza al solai.

False ceiling with lay-in structure. The installation of lighting fittings occurs directly on the structure with "T" profile. Safe anchoring on the concrete slab recommended.

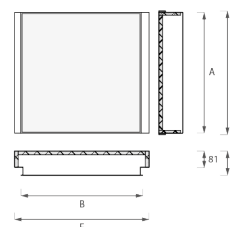
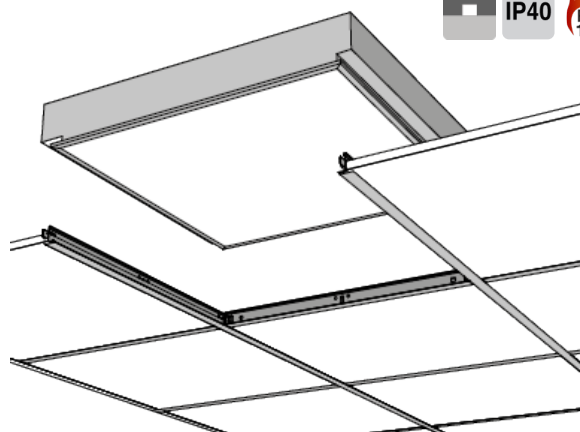

PMO

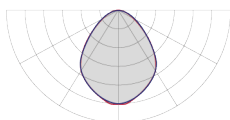

Potenza Power [W]	Temp. colore Colour Temp. [K]	IRC CRI	Flusso lum. Lum. flux [lm]	Efficienza lum. Lum. effic. [lm / W]	Dimensioni / Dimensions [mm]					Cod. / Code LED	Cod. / Code LED DALI
					A	B	C	D	E		
32	3000	>80	3552	111	590	595	121	605	660	146000353	146000354
32	4000	>80	3744	117	590	595	121	605	660	146000355	146000356
38	3000	>80	4218	111	590	595	121	605	660	146000357	146000358
38	4000	>80	4446	117	590	595	121	605	660	146000359	146000360
44	3000	>80	4884	111	590	595	121	605	660	146000361	146000362
44	4000	>80	5148	117	590	595	121	605	660	146000363	146000364
50	3000	>80	5550	111	590	595	121	605	660	146000365	146000366
50	4000	>80	5850	117	590	595	121	605	660	146000367	146000368

MOT

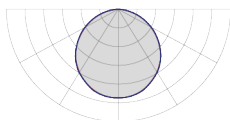

Potenza Power [W]	Temp. colore Colour Temp. [K]	IRC CRI	Flusso lum. Lum. flux [lm]	Efficienza lum. Lum. effic. [lm / W]	Dimensioni / Dimensions [mm]					Cod. / Code LED	Cod. / Code LED DALI
					A	B	C	D	E		
32	3000	>80	3360	105	590	595	121	605	660	146000337	146000338
32	4000	>80	3552	111	590	595	121	605	660	146000339	146000340
38	3000	>80	3990	105	590	595	121	605	660	146000341	146000342
38	4000	>80	4218	111	590	595	121	605	660	146000343	146000344
44	3000	>80	4620	105	590	595	121	605	660	146000345	146000346
44	4000	>80	4884	111	590	595	121	605	660	146000347	146000348
50	3000	>80	5250	105	590	595	121	605	660	146000349	146000350
50	4000	>80	5550	111	590	595	121	605	660	146000351	146000352

Skin



Skin.10

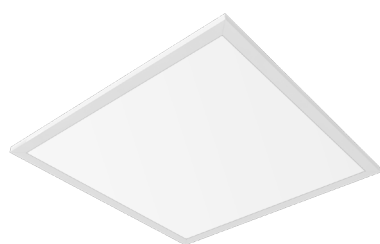

Skin.33

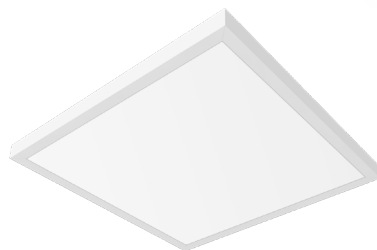

Caratteristiche tecniche

Technical Characteristics

Corpo	Telaio in alluminio estruso	Body	Extruded aluminium frame
Colore	○ Bianco	Colour	○ White
Gruppo ottico	<ul style="list-style-type: none"> PSU - polistirene microprismatico (UGR<19) PSO - guida luce in PMMA e diffusore in polistirene 	Optical group	<ul style="list-style-type: none"> PSU - microprismatic polystyrene (UGR<19) PSO - PMMA light guide and polystyrene diffuser
Cablaggio	<ul style="list-style-type: none"> LED ON/OFF con driver integrato LED DALI con driver integrato <p><u>Su richiesta:</u></p> <ul style="list-style-type: none"> Kit di EMERGENZA (autonomia 1/3 h) 	Wiring	<ul style="list-style-type: none"> LED ON/OFF with integrated driver LED DALI with integrated driver <p><u>On request:</u></p> <ul style="list-style-type: none"> EMERGENCY kit (1/3 h autonomy)
Grado di protezione	<ul style="list-style-type: none"> IP 40 (SKIN.10) IP 44 (SKIN.33) 	Protection degree	<ul style="list-style-type: none"> IP 40 (SKIN.10) IP 44 (SKIN.33)

Sorgenti LED

LED sources

IRC	<ul style="list-style-type: none"> >80 (SKIN.10; SKIN.33) >90 (SKIN.33) 	CRI	<ul style="list-style-type: none"> >80 (SKIN.10; SKIN.33) >90 (SKIN.33)
Temp. colore	<ul style="list-style-type: none"> 3000 K 4000 K 	Colour Temp.	<ul style="list-style-type: none"> 3000 K 4000 K

Gruppi ottici

Optical groups

PSU

Diffusore in polistirene microprismatico anabbagliante ad emissione luminosa controllata. Conforme ad essere installata in ambienti con uso di videoterminali secondo la norma UNI EN 12464-1.

Diffuser made of anti-glare microprismatic polystyrene with controlled luminance emission. Suitable for installation in workplaces with the use of video terminals according to EN 12464-1 standard.

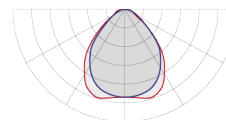

UGR
≤19

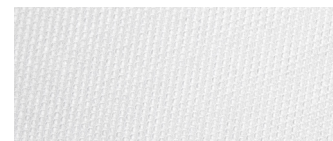

PSO

Ottica composta da guida luce in PMMA e diffusore in polistirene ad effetto bianco brillante.

Diffuser composed by PMMA light guide and polystyrene diffuser with white bright effect.

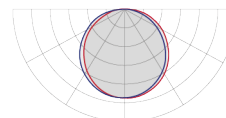

Tipologia di installazione

Type of installation

CARTONGESSO

Plasterboard

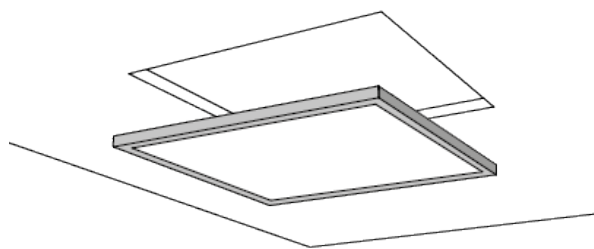

267mm x 267mm
267mm x 567mm
567mm x 567mm
267mm x 1167mm
567mm x 1167mm

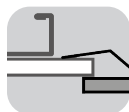

Controsoffitto in cartongesso.

L'installazione dei corpi illuminanti avviene tramite molle di fissaggio regolabili. Si consiglia la pendinatura di sicurezza al solaio.

Plasterboard false ceiling.

The installation of the lighting fittings occurs by adjustable fixing springs. Safe anchoring on the concrete slab recommended.

CONTROSOFFITTO LAY-IN

Lay-in false ceiling

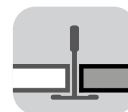
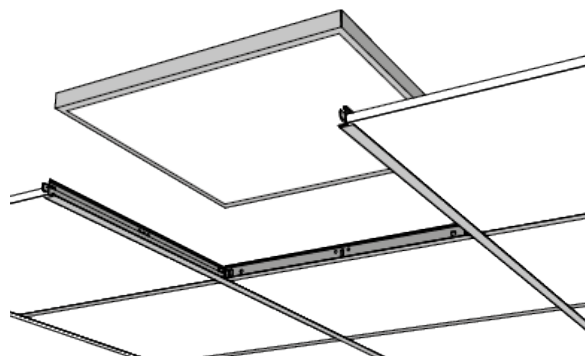

Controsoffitto con struttura a vista. L'installazione dei corpi illuminanti avviene direttamente in appoggio alla struttura portante con profilo a "T", senza staffe di fissaggio.

Si consiglia la pendinatura di sicurezza al solaio.

False ceiling with lay-in structure. The installation of lighting fittings occurs directly on the structure with "T" profile.

Safe anchoring on the concrete slab recommended.

Accessori (da ordinare separatamente)
Accessories (to be ordered separately)



MOLLE DI FISSAGGIO SPRINGS

Cod. / Code **KC1786000x**

- **5**: (4 pcs. kit) 300x300 mm; 300x600 mm; 600x600 mm
- **6**: (6 pcs. kit) 300x1200 mm; 600x1200 mm

PLAFONE

Ceiling

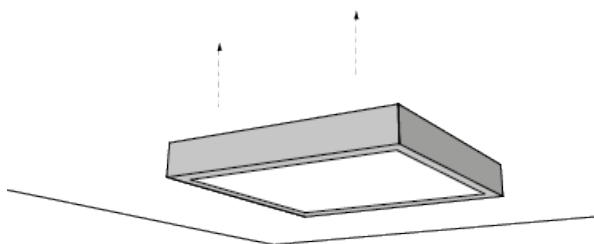

Accessori (da ordinare separatamente)
Accessories (to be ordered separately)



CORNICE DI FISSAGGIO A PLAFONE ALUMINIUM FRAME FOR CEILING APPLICATION

Cod. / Code **KMP1786230x**

Colore bianco/ White colour

- **3030B**: 600x600 mm (H: 45mm)
- **3060B**: 300x600 mm (H: 45mm)
- **6060B**: 600x600 mm (H: 45mm)
- **3120B**: 300x1200 mm (H: 45mm)
- **6120B**: 300x1200 mm (H: 45mm)
- **6070B**: 600x600 mm (H: 70mm)
- **3170B**: 300x1200 mm (H: 70mm)

SOSPENSIONE

Suspension

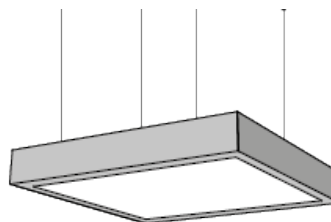

Accessori (da ordinare separatamente)
Accessories (to be ordered separately)



L= 1500mm

KIT DI SOSPENSIONE SUSPENSION KIT

Cod. / Code **KS1x**

Tenditori in acciaio / Steel cable suspensions

- **50**: 300x300 mm (4 pcs. kit)
- **54**: 300x600 mm (4 pcs. kit)
- **60**: 600x600 mm (4 pcs. kit)
- **51**: 300x1200 mm (6 pcs. kit)
- **55**: 300x1200 mm (6 pcs. kit)

SKIN.33

- **56**: 300x300 mm (4 pcs. kit)
- **57**: 300x1200 mm (4 pcs. kit)

PSU

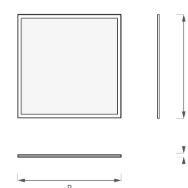
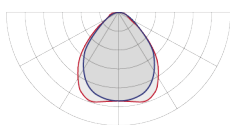

	Potenza Power [W]	Temp. colore Colour Temp. [K]	IRC CRI	Flusso lum. Lum. flux [lm]	Efficienza lum. Lum. effic. [lm / W]	Dimensioni / Dimensions [mm]			Cod. / Code LED	Cod. / Code LED DALI
						A	B	C		
SKIN.10	40	3000	>80	3720	93	595	595	10	178600285	178600303
SKIN.10	40	4000	>80	4000	100	595	595	10	178600057	178600295
SKIN.10	40	3000	>80	3720	93	295	1195	10	178600273	178600304
SKIN.10	40	4000	>80	4000	100	295	1195	10	178600259	178600294
SKIN.33	40	3000	>90	4300	107	595	595	33	178600308	178600309
SKIN.33	40	4000	>90	4620	115	595	595	33	178600307	178600278
SKIN.33	40	3000	>90	3800	95	295	1195	33	178600310	178600311
SKIN.33	40	4000	>90	4000	100	295	1195	33	178600312	178600313

PSO

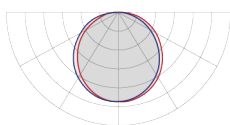

	Potenza Power [W]	Temp. colore Colour Temp. [K]	IRC CRI	Flusso lum. Lum. flux [lm]	Efficienza lum. Lum. effic. [lm / W]	Dimensioni / Dimensions [mm]			Cod. / Code LED	Cod. / Code LED DALI
						A	B	C		
SKIN.10	12	3000	>80	900	75	295	295	10	178600286	178600296
SKIN.10	12	4000	>80	960	80	295	295	10	178600287	178600297
SKIN.10	18	3000	>80	1520	84	295	595	10	178600288	178600298
SKIN.10	18	4000	>80	1620	90	295	595	10	178600269	178600299
SKIN.10	40	3000	>80	3720	93	295	1195	10	178600267	178600300
SKIN.10	40	4000	>80	4000	100	295	1195	10	178600222	178600275
SKIN.10	48	3000	>80	4470	93	595	1195	10	178600289	178600301
SKIN.10	48	4000	>80	4800	100	595	1195	10	178600226	178600302
SKIN.10	40	3000	>80	3900	97	595	595	10	178600271	178600282
SKIN.10	40	4000	>80	4230	105	595	595	10	178600218	178600262
SKIN.33	40	3000	>80	3870	96	595	595	33	178600333	178600334
SKIN.33	40	4000	>80	4160	104	595	595	33	178600370	178600371

1) Il flusso effettivo potrebbe avere una tolleranza del ±10%. / The effective flux could have a tolerance of ±10%.

4 Side



Caratteristiche tecniche

Technical Characteristics

Corpo	Lamiera di acciaio	Body	Sheet-steel
Colore	<ul style="list-style-type: none"> ○ Bianco opaco (RAL9003) <u>Su richiesta:</u> ● Altri colori 	Colour	<ul style="list-style-type: none"> ○ Matt white (RAL9003) <u>On request:</u> ● Other colours available
Gruppo ottico	<ul style="list-style-type: none"> • PSU - polistirene microprismatico (UGR<19) • MOT - metacrilato opale 	Optical group	<ul style="list-style-type: none"> • PSU - microprismatic polystyrene (UGR<19) • MOT - opal methacrylate
Cablaggio	<ul style="list-style-type: none"> • LED ON/OFF con driver integrato • LED DALI con driver integrato <u>Su richiesta:</u> • Kit di EMERGENZA (autonomia 1/3 h) 	Wiring	<ul style="list-style-type: none"> • LED ON/OFF with integrated driver • LED DALI with integrated driver <u>On request:</u> • EMERGENCY kit (1/3 h autonomy)
Grado di protezione	• IP 40/20	Protection degree	• IP 40/20

Sorgenti LED

LED sources

IRC	<ul style="list-style-type: none"> >80 <u>Su richiesta:</u> >90 	CRI	<ul style="list-style-type: none"> >80 <u>On request:</u> >90
Temp. colore	<ul style="list-style-type: none"> • 3000 K • 4000 K <u>Su richiesta:</u> • TUNABLE WHITE 2700-6500 K 	Colour Temp.	<ul style="list-style-type: none"> • 3000 K • 4000 K <u>On request:</u> • TUNABLE WHITE 2700-6500 K

Ottiche

Diffusers

PSU

Diffusore in polistirene microprismatico anabagliante ad emissione luminosa controllata. Conforme ad essere installata in ambienti con uso di videoterminali secondo la norma UNI EN 12464-1.
Diffuser made of anti-glare microprismatic polystyrene with controlled luminance emission. Suitable for installation in workplaces with the use of video terminals according to EN 12464-1 standard.

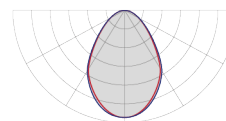

UGR <19

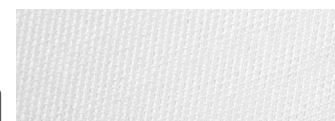

MOT

Diffusore in metacrilato opale ad alta trasmittanza, ideale per una distribuzione uniforme.
Diffuser in opal methacrylate with high transmittance, ideal for uniform distribution.

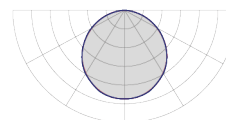

Tipologia di installazione

Type of installation

CONTROSOFFITTO LAY-IN

Lay-in ceiling

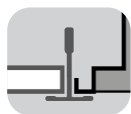
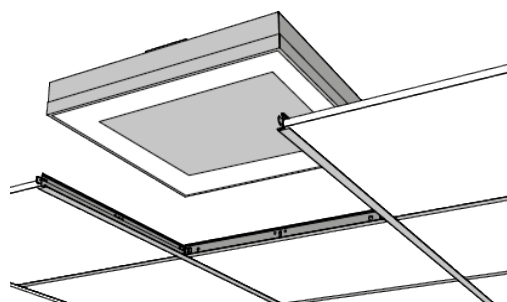

IP
40/20

Controsoffitto con struttura a vista. L'installazione dei corpi illuminanti avviene direttamente in appoggio alla struttura portante con profilo a "T", senza staffe di fissaggio. Si consiglia la pendinatura di sicurezza al solaio.

False ceiling with lay-in structure. The installation of lighting fittings occurs directly on the structure with "T" profile. Safe anchoring on the concrete slab recommended.

4 SIDE/EASY LINE

Su richiesta / On request

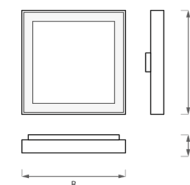
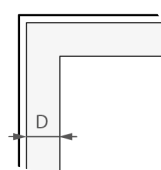
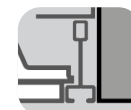

PSU

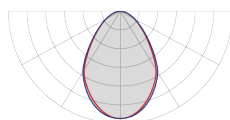

Potenza Power [W]	Temp. colore Colour Temp. [K]	IRC CRI	Flusso lum. Lum. flux [lm]	Efficienza lum. Lum. effic. [lm / W]	Dimensioni / Dimensions [mm]				Cod. / Code LED	Cod. / Code LED DALI
					A	B	C	D		
33	3000	>80	3498	106	595	595	76	50	144200026	144200027
33	4000	>80	3795	115	595	595	76	50	144200030	144200031
52	3000	>80	5512	106	595	595	76	50	144200028	144200029
52	4000	>80	5980	115	595	595	76	50	144200032	144200033

MOT

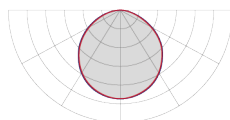

Potenza Power [W]	Temp. colore Colour Temp. [K]	IRC CRI	Flusso lum. Lum. flux [lm]	Efficienza lum. Lum. effic. [lm / W]	Dimensioni / Dimensions [mm]				Cod. / Code LED	Cod. / Code LED DALI
					A	B	C	D		
33	3000	>80	3168	96	595	595	76	50	144200018	144200019
33	4000	>80	3300	100	595	595	76	50	144200022	144200023
52	3000	>80	4992	96	595	595	76	50	144200020	144200021
52	4000	>80	5200	100	595	595	76	50	144200024	144200025

Duoled



Caratteristiche tecniche

Technical Characteristics

Corpo	Lamiera di acciaio	Body	Sheet-steel
Colore	<input type="radio"/> Bianco opaco (RAL9003) Su richiesta: <input checked="" type="radio"/> Altri colori	Colour	<input type="radio"/> Matt white (RAL9003) On request: <input checked="" type="radio"/> Other colours available
Gruppo ottico	<ul style="list-style-type: none"> PMO - policarbonato microprismatico (UGR<19) MOT - metacrilato opale 	Optical group	<ul style="list-style-type: none"> PMO - microprismatic polycarbonate (UGR<19) MOT - opal methacrylate
Cablaggio	<ul style="list-style-type: none"> LED ON/OFF con driver integrato LED DALI con driver integrato Su richiesta: <ul style="list-style-type: none"> Kit di EMERGENZA (autonomia 1/3 h) 	Wiring	<ul style="list-style-type: none"> LED ON/OFF with integrated driver LED DALI with integrated driver On request: <ul style="list-style-type: none"> EMERGENCY kit (1/3 h autonomy)
Grado di protezione	<ul style="list-style-type: none"> IP 54/20 	Protection degree	<ul style="list-style-type: none"> IP 54/20

Sorgenti LED

LED sources

IRC	>80 Su richiesta: >90	CRI	>80 On request: >90
Temp. colore	<ul style="list-style-type: none"> 3000 K 4000 K Su richiesta: <ul style="list-style-type: none"> TUNABLE WHITE 2700-6500 K 	Colour Temp.	<ul style="list-style-type: none"> 3000 K 4000 K On request: <ul style="list-style-type: none"> TUNABLE WHITE 2700-6500 K

Ottiche

Diffusers

PMO

Diffusore in policarbonato microprismatico anabbagliante. Valori di luminanza < 3000 cd/m² per angoli > 65°. Film interno in policarbonato opale anabbagliante per una maggiore uniformità luminosa. Conforme ad essere installata in ambienti con uso di videoterminali secondo la norma UNI EN 12464-1.

Diffuser made of anti-glare microprismatic polycarbonate. Luminance values <3000 cd/m² for angles >65°. Internal anti-glare opal polycarbonate film for a better light uniformity. Suitable for installation in workplaces with the use of video terminals according to EN 12464-1 standard.

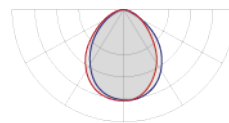

MOT

Diffusore in metacrilato opale ad alta trasmittanza, ideale per una distribuzione uniforme.

Diffuser in opal methacrylate with high transmittance, ideal for uniform distribution.

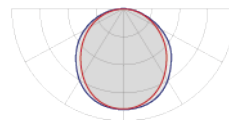

Tipologia di installazione

Type of installation

CONTROSOFFITTO LAY-IN

Lay-in ceiling



Controsoffitto con struttura a vista. L'installazione dei corpi illuminanti avviene direttamente in appoggio alla struttura portante con profilo a "T", senza staffe di fissaggio. Si consiglia la pendinatura di sicurezza al solaio.

False ceiling with lay-in structure. The installation of lighting fittings occurs directly on the structure with "T" profile. Safe anchoring on the concrete slab recommended.

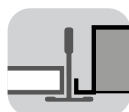
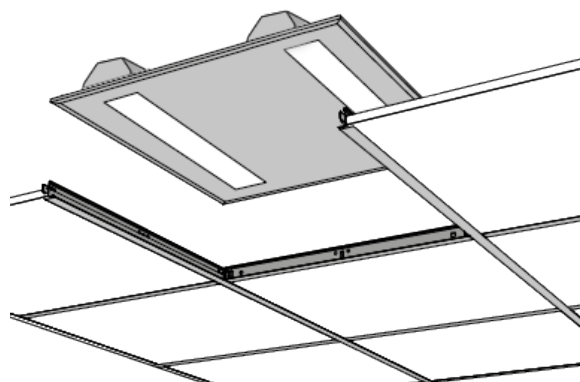

PMO

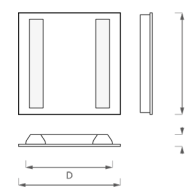
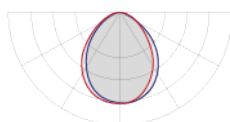

Potenza Power [W]	Temp. colore Colour Temp. [K]	IRC CRI	Flusso lum. Lum. flux [lm]	Efficienza lum. Lum. effic. [lm / W]	Dimensioni / Dimensions [mm]				Cod. / Code LED	Cod. / Code LED DALI
					A	B	C	D		
26	3000	>80	3172	122	595	595	70	511	178100144	178100145
26	4000	>80	3406	131	595	595	70	511	178100146	178100147
32	3000	>80	3904	122	595	595	70	511	178100148	178100149
32	4000	>80	4192	131	595	595	70	511	178100150	178100151
40	3000	>80	4880	122	595	595	70	511	178100152	178100153
40	4000	>80	5240	131	595	595	70	511	178100154	178100155
48	3000	>80	5856	122	595	595	70	511	178100156	178100157
48	4000	>80	6288	131	595	595	70	511	178100158	178100159

MOT

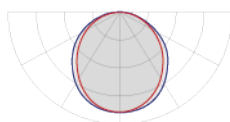

Potenza Power [W]	Temp. colore Colour Temp. [K]	IRC CRI	Flusso lum. Lum. flux [lm]	Efficienza lum. Lum. effic. [lm / W]	Dimensioni / Dimensions [mm]				Cod. / Code LED	Cod. / Code LED DALI
					A	B	C	D		
26	3000	>80	3172	122	595	595	70	511	178100128	178100129
26	4000	>80	3406	131	595	595	70	511	178100130	178100131
32	3000	>80	3904	122	595	595	70	511	178100132	178100133
32	4000	>80	4192	131	595	595	70	511	178100134	178100135
40	3000	>80	4880	122	595	595	70	511	178100136	178100137
40	4000	>80	5240	131	595	595	70	511	178100138	178100139
48	3000	>80	5856	122	595	595	70	511	178100140	178100141
48	4000	>80	6288	131	595	595	70	511	178100142	178100143

Plate

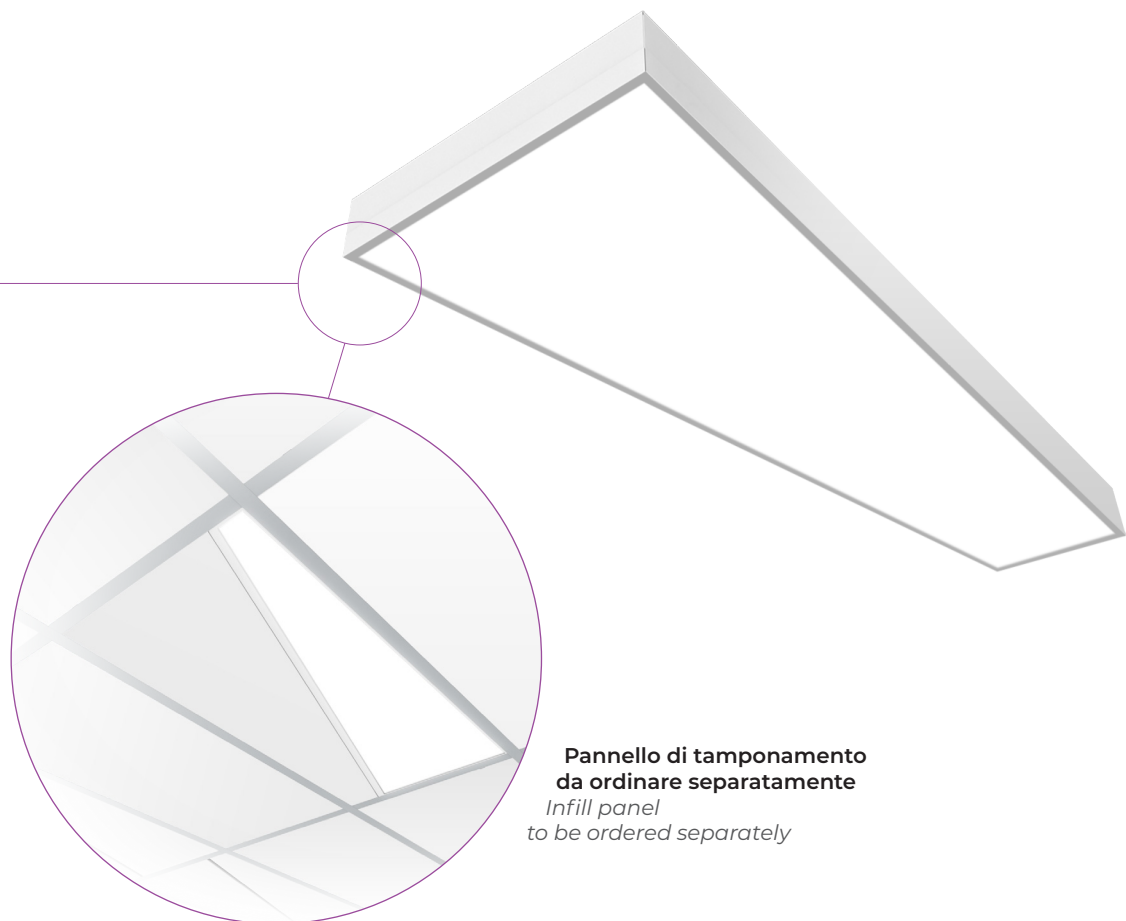

Pannello di tamponamento da ordinare separatamente
Infill panel to be ordered separately

Caratteristiche tecniche

Technical Characteristics

Corpo	Lamiera di acciaio	Body	Sheet-steel
Colore	○ Bianco opaco (RAL9003) <u>Su richiesta:</u> ● Altri colori	Colour	○ Matt white (RAL9003) <u>On request:</u> ● Other colours available
Gruppo ottico	· MOT - metacrilato opale	Optical group	· MOT - opal methacrylate
Cablaggio	· LED ON/OFF con driver integrato · LED DALI con driver integrato <u>Su richiesta:</u> · Kit di EMERGENZA (autonomia 1/3 h)	Wiring	· LED ON/OFF with integrated driver · LED DALI with integrated driver <u>On request:</u> · EMERGENCY kit (1/3 h autonomy)
Grado di protezione	· IP 40	Protection degree	· IP 40

Sorgenti LED

LED sources

IRC	>80 <u>Su richiesta:</u> >90	CRI	>80 <u>On request:</u> >90
Temp. colore	· 3000 K · 4000 K <u>Su richiesta:</u> · TUNABLE WHITE 2700-6500 K	Colour Temp.	· 3000 K · 4000 K <u>On request:</u> · TUNABLE WHITE 2700-6500 K

Gruppi ottici

Optical groups

MOT

Diffusore in metacrilato opale ad alta trasmittanza, ideale per una distribuzione uniforme.

Diffuser in opal methacrylate with high transmittance, ideal for uniform distribution.

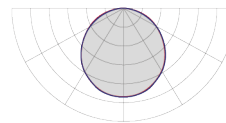

Tipologia di installazione

Type of installation

CONTROSOFFITTO LAY-IN

Lay-in false ceiling



Controsoffitto con struttura a vista. L'installazione dei corpi illuminanti avviene direttamente in appoggio alla struttura portante con profilo a "T", senza staffe di fissaggio.

Si consiglia la pendinatura di sicurezza al solaio.

False ceiling with lay-in structure. The installation of lighting fittings occurs directly on the structure with "T" profile, without fasteners. Safe anchoring on the concrete slab recommended.

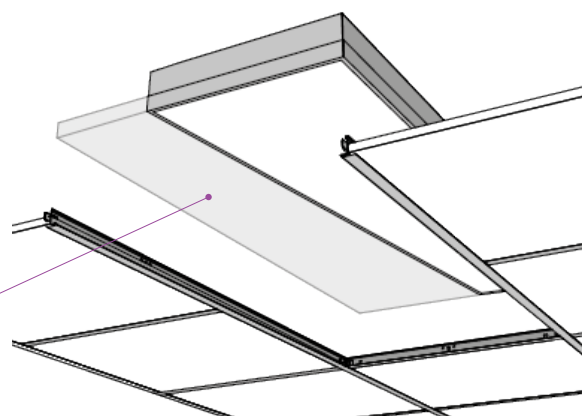

Accessori (da ordinare separatamente)
Accessories (to be ordered separately)

PANNELLO DI TAMPONAMENTO

INFILL PANEL

Cod. / Code 90000085x

Pannello trapezoidale in lamiera di acciaio, colore bianco opaco (RAL 9003).

Sheet steel trapezoidal infill panel, matt white colour (RAL 9003).

- **2**: Pannello adatto alla versione sinistra/ Infill panel for left version
- **3**: Pannello adatto alla versione destra/ Infill panel for right version



Versione destra / Right version

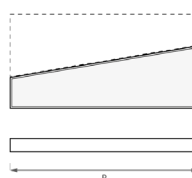

Versione sinistra / Left version

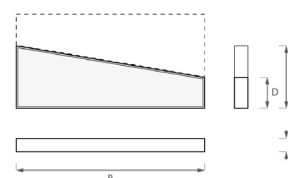

MOT

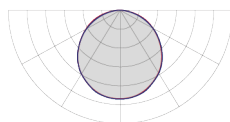

Potenza Power [W]	Temp. colore Colour Temp. [K]	IRC CRI	Flusso lum. Lum. flux [lm]	Efficienza lum. Lum. effic. [lm / W]	Dimensioni / Dimensions [mm]				Cod. / Code LED	Cod. / Code LED DALI
					A	B	C	D		
72	3000	>80	8271	114	395	1195	85	195	178700012	178700014
72	4000	>80	8894	123	395	1195	85	195	178700013	178700015
72	3000	>80	8271	114	395	1195	85	195	178700016	178700018
72	4000	>80	8894	123	395	1195	85	195	178700017	178700019

1) Il flusso effettivo potrebbe avere una tolleranza del ±10%. / The effective flux could have a tolerance of ±10%.

INCASSI PER DOGHE

RECESSED FOR STAVES

Tipologia di doghe

Type of staves

A

Doghe aperte simmetriche con bordi arrotondati. Le doghe vanno applicate a scatto su orditura portante costituita da traversine in acciaio che rendono il controsoffitto smontabile in ogni singola dogha.

Symmetric open staves with rounded edges.

The staves are spring-applied on bearing frame composed of steel ties so that the false ceiling is detachable in any single stave.

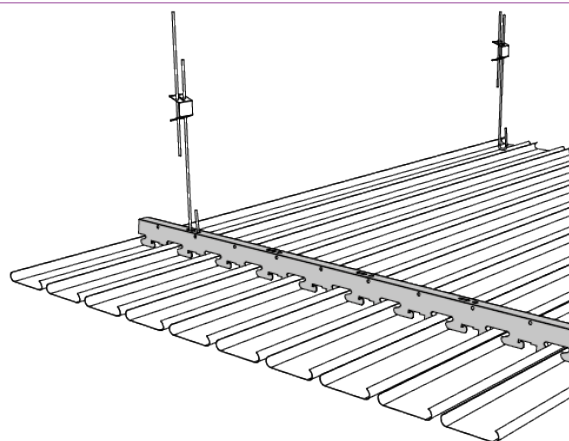

P [mm]	90	100	150	200
L [mm]	85	85	135	185
F [mm]	5	15	15	15
H [mm]	16	16	16	16
AT/1			-	-
AT/184	-		-	
AT/284	-			-
AT/20	-	-	-	-
AT/C 230	-		-	
AT/S 180	-	-	-	-
STREET P/30	-	-	-	-

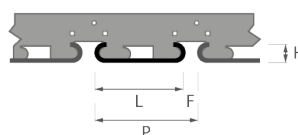

AC

Doghe chiuse asimmetriche con bordi arrotondati. Le doghe vanno applicate a scatto su orditura portante costituita da traversine in acciaio che rendono il controsoffitto smontabile in ogni singola dogha.

Asymmetric closed staves with rounded edges.

The staves are spring-applied on bearing frame composed of steel ties so that the false ceiling is detachable in any single stave.

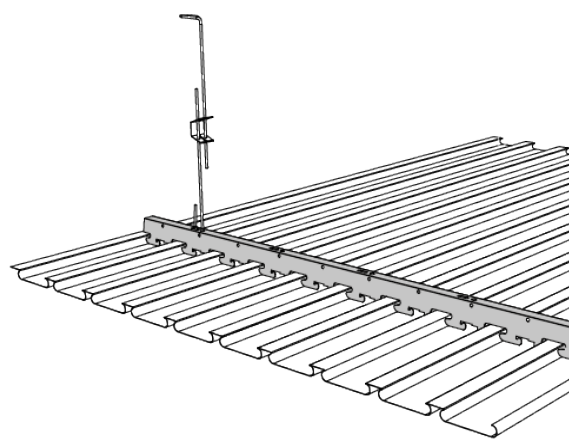

P [mm]	100	150	200
L [mm]	85	135	185
F [mm]	15	15	15
H [mm]	16	16	16
AT/1		-	-
AT/184		-	
AT/284			-
AT/20	-	-	-
AT/C 230		-	
AT/S 180	-	-	-
STREET P/30	-	-	-

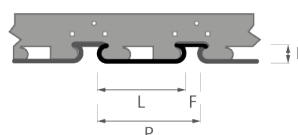

Tipologia di doghe

Type of staves

C

Doghe chiuse asimmetriche con bordi spigolati, con due possibilità di montaggio: doghe distanziate tra loro o doghe accostate. Le doghe vengono applicate a scatto su orditura portante costituita da traversine in acciaio che rendono il controsoffitto smontabile in ogni singola dogha.

Asymmetric closed staves with sharp edges. Staves series "C" can be linked in two ways: spaced staves or approached staves. The staves are spring-applied on a bearing frame composed of steel ties so that the false ceiling is detachable in any single stave.

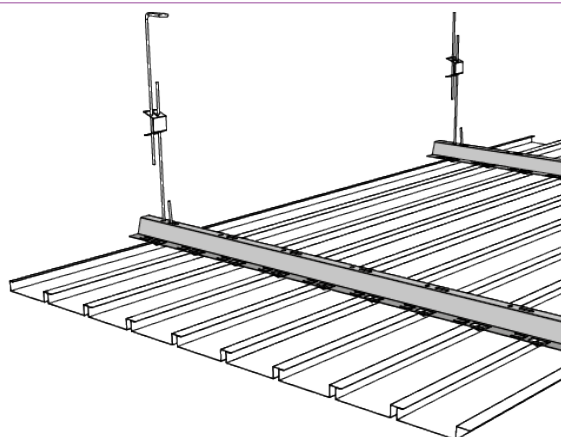

P [mm]	100	150	200	300
L [mm]	90	140	190	290
F [mm]	10	10	10	10
H [mm]	17	17	17	17
AT/1	-	-	-	-
AT/184	-	-	-	-
AT/284	-	-	-	-
AT/20		-		-
AT/C 230		-		-
AT/S 180	-	-	-	-
STREET P/30	-	-	-	-

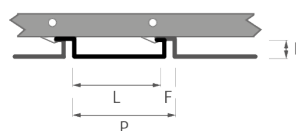

S

Doghe scatolato simmetriche con bordi spigolati applicata a scatto su traversine multi-modulari con la possibilità di inserire tra le une e le altre un profilo speciale, rendendo il controsoffitto chiuso ed isolato dal plenum.

Symmetric box staves with sharp edges spring-applied on multi-modular ties and a special section can be inserted between the staves in order to insulate the false ceiling from the rest.

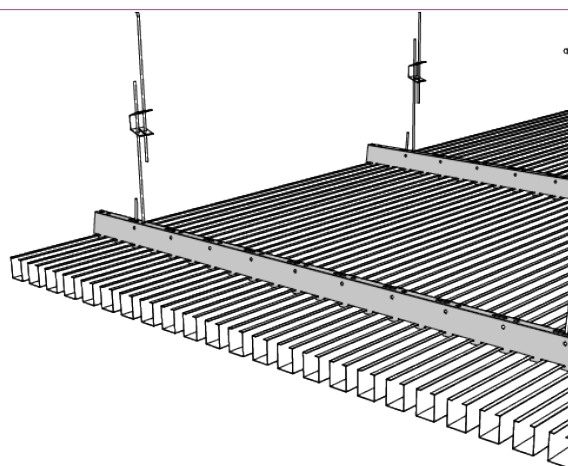

P [mm]	50	100	200
L [mm]	30	80	180
F [mm]	20	20	20
H [mm]	38	15	15
AT/1	-	-	-
AT/184	-	-	-
AT/284	-	-	-
AT/20	-	-	-
AT/C 230			
AT/S 180			
STREET P/30		-	-

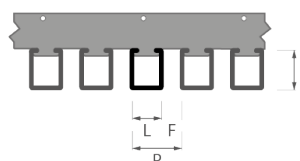

AT/1

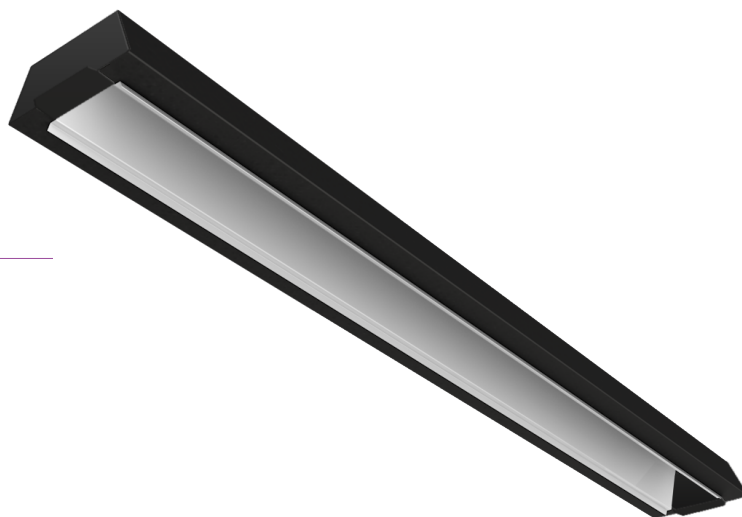

Caratteristiche tecniche

Technical Characteristics

Corpo	Lamiera di acciaio	Body	Sheet-steel
Colore	● Nero	Colour	● Black
Gruppo ottico	<ul style="list-style-type: none"> • Riflettore interno in alluminio bianco con cover in policarbonato opale <p><u>Su richiesta:</u></p> <ul style="list-style-type: none"> • Frangiluce in alluminio verniciato • Doga in policarbonato rigato 	Optical group	<ul style="list-style-type: none"> • Internal reflector in white aluminium whit opal polycarbonate cover <p><u>On request:</u></p> <ul style="list-style-type: none"> • Lamellar louvre • Striped polycarbonate slat
Cablaggio	<ul style="list-style-type: none"> • LED ON/OFF con driver integrato • LED DALI con driver integrato <p><u>Su richiesta:</u></p> <ul style="list-style-type: none"> • Kit di EMERGENZA (autonomia 1/3 h) 	Wiring	<ul style="list-style-type: none"> • LED ON/OFF with integrated driver • LED DALI with integrated driver <p><u>On request:</u></p> <ul style="list-style-type: none"> • EMERGENCY kit (1/3 h autonomy)
Grado di protezione	• IP 20	Protection degree	• IP 20

Sorgenti LED

LED sources

IRC	>80	CRI	>80
	<u>Su richiesta:</u>		<u>On request:</u>
	>90		>90
Temp. colore	<ul style="list-style-type: none"> • 3000 K • 4000 K 	Colour Temp.	<ul style="list-style-type: none"> • 3000 K • 4000 K

Tipologia di installazione

Type of installation

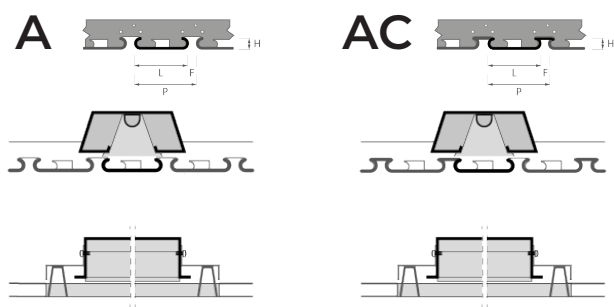

P [mm]	90	100
L [mm]	85	85
F [mm]	5	15
H [mm]	16	16

P [mm]	100
L [mm]	85
F [mm]	15
H [mm]	16

Accessori (da ordinare separatamente)

Accessories (to be ordered separately)

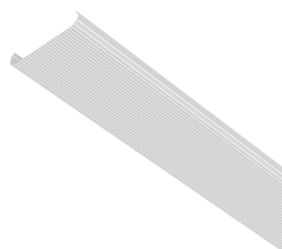

**FRANGILUCE
LIGHTBREAKER**
Cod. / Code DT100A_XPOL10
in policarbonato rigato, adatto a
doghe P90 o P100.
smooth surface polycarbonate,
staves P90 or P100

- **0750** : L=750mm
- **1350** : L=1350mm
- **1650** : L=1650mm

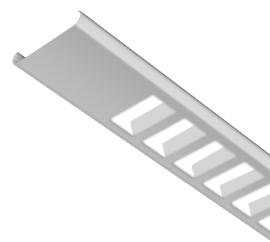
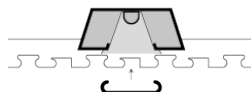
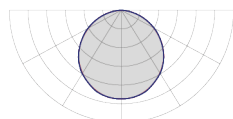

**FRANGILUCE
LIGHTBREAKER**
Cod. / Code DT100A_XALL_ in alluminio verniciato, adatto a
doghe P90 o P100.
coloured aluminium
lightbreaker, staves P90 or P100

- **750** : L=750mm
- **1350** : L=1350mm
- **1650** : L=1650mm

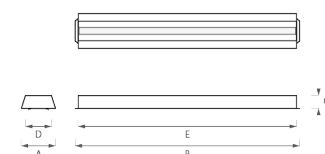
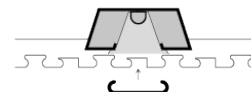
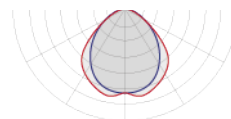

Potenza Power [W]	Temp. colore Colour Temp. [K]	IRC CRI	Flusso lum. Lum. flux [lm]	Efficienza lum. Lum. effic. [lm / W]	Dimensioni / Dimensions [mm]					Cod. / Code LED	Cod. / Code LED DALI
					A	B	C	D	E		
13	3000	>80	1443	111	150	665	56	114	630	101000033	101000034
13	4000	>80	1560	120	150	665	56	114	630	101000016	101000017
26	3000	>80	2886	111	150	1265	56	114	1230	101000035	101000036
26	4000	>80	3120	120	150	1265	56	114	1230	101000020	101000021
33	3000	>80	3663	111	150	1565	56	114	1530	101000037	101000038
33	4000	>80	3960	120	150	1565	56	114	1530	101000024	101000025

AT/184



Caratteristiche tecniche

Technical Characteristics

Corpo	Lamiera di acciaio	Body	Sheet-steel
Colore	○ Bianco opaco (RAL9003)	Colour	○ Matt white (RAL9003)
Gruppo ottico	<ul style="list-style-type: none"> PMO - policarbonato microprismatico (UGR<19) MOT - metacrilato opale 	Optical group	<ul style="list-style-type: none"> PMO - microprismatic polycarbonate (UGR<19) MOT - opal methacrylate
Cablaggio	<ul style="list-style-type: none"> LED ON/OFF con driver integrato LED DALI con driver integrato <p><u>Su richiesta:</u></p> <ul style="list-style-type: none"> Kit di EMERGENZA (autonomia 1/3 h) 	Wiring	<ul style="list-style-type: none"> LED ON/OFF with integrated driver LED DALI with integrated driver <p><u>On request:</u></p> <ul style="list-style-type: none"> EMERGENCY kit (1/3 h autonomy)
Grado di protezione	<ul style="list-style-type: none"> IP 40/20 	Protection degree	<ul style="list-style-type: none"> IP 40/20

Sorgenti LED

LED sources

IRC	<ul style="list-style-type: none"> >80 <p><u>Su richiesta:</u></p> <ul style="list-style-type: none"> >90 	CRI	<ul style="list-style-type: none"> >80 <p><u>On request:</u></p> <ul style="list-style-type: none"> >90
Temp. colore	<ul style="list-style-type: none"> 3000 K 4000 K <p><u>Su richiesta:</u></p> <ul style="list-style-type: none"> TUNABLE WHITE 2700-6500 K 	Colour Temp.	<ul style="list-style-type: none"> 3000 K 4000 K <p><u>On request:</u></p> <ul style="list-style-type: none"> TUNABLE WHITE 2700-6500 K

Ottiche

Diffusers

PMO

Diffusore in policarbonato microprismatico anabbagliante. Valori di luminanza < 3000 cd/m² per angoli > 65°. Film interno in policarbonato opale anabbagliante per una maggiore uniformità luminosa. Conforme ad essere installata in ambienti con uso di videoterminali secondo la norma UNI EN 12464-1.

Diffuser made of anti-glare microprismatic polycarbonate. Luminance values <3000 cd/m² for angles >65°. Internal anti-glare opal polycarbonate film for a better light uniformity. Suitable for installation in workplaces with the use of video terminals according to EN 12464-1 standard.

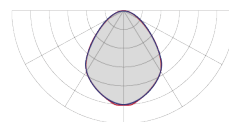

UGR
<19

MOT

Diffusore in metacrilato opale ad alta trasmittanza, ideale per una distribuzione uniforme.

Diffuser in opal methacrylate with high transmittance, ideal for uniform distribution.

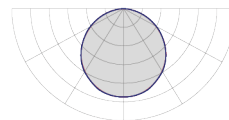

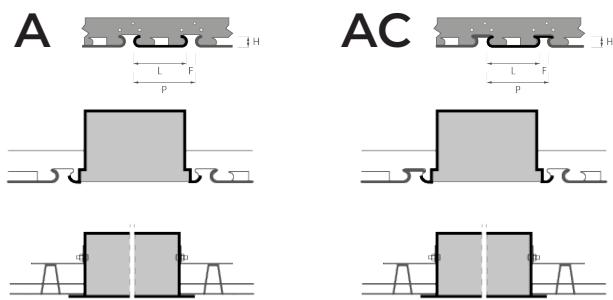

P [mm]	100	200
L [mm]	85	185
F [mm]	15	15
H [mm]	16	16

P [mm]	100	200
L [mm]	85	185
F [mm]	15	15
H [mm]	16	16

Accessori (da ordinare separatamente)
Accessories (to be ordered separately)

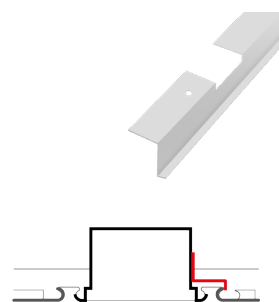

COPRIFUGA LATERALE
SIDE COVER
Cod. / Code CF00x
 Acciaio preverniciato bianco.
 Viti fornite in dotazione
 White pre-painted steel.
 Fixing screws included.

- **1**: L = 660mm
- **2**: L = 1270mm
- **3**: L = 1570mm

PMO

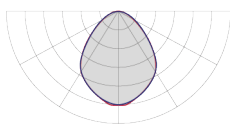

Potenza Power [W]	Temp. colore Colour Temp. [K]	IRC CRI	Flusso lum. Lum. flux [lm]	Efficienza lum. Lum. effic. [lm / W]	Dimensioni / Dimensions [mm]					Cod. / Code LED	Cod. / Code LED DALI
					A	B	C	D	E		
13	3000	>80	1572	121	184	660	100	630	145	107000172	107000173
13	4000	>80	1695	131	184	660	100	630	145	107000170	107000178
26	3000	>80	3143	121	184	1270	100	1230	145	107000175	107000174
26	4000	>80	3390	131	184	1270	100	1230	145	107000207	107000179
33	3000	>80	3989	121	184	1570	100	1530	145	107000176	107000177
33	4000	>80	4302	131	184	1570	100	1530	145	107000210	107000180
24	3000	>80	2904	121	184	660	100	630	145	107000181	107000182
24	4000	>80	3144	131	184	660	100	630	145	107000189	107000190
48	3000	>80	5808	121	184	1270	100	1230	145	107000183	107000184
48	4000	>80	6288	131	184	1270	100	1230	145	107000191	107000192
60	3000	>80	7260	121	184	1570	100	1530	145	107000185	107000186
60	4000	>80	7860	131	184	1570	100	1530	145	107000193	107000194

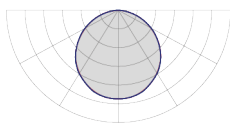

MOT



Potenza Power [W]	Temp. colore Colour Temp. [K]	IRC CRI	Flusso lum. Lum. flux [lm]	Efficienza lum. Lum. effic. [lm / W]	Dimensioni / Dimensions [mm]					Cod. / Code LED	Cod. / Code LED DALI
					A	B	C	D	E		
13	3000	>80	1490	115	184	660	100	630	145	107000195	107000196
13	4000	>80	1609	124	184	660	100	630	145	107000205	107000206
26	3000	>80	2984	115	184	1270	100	1230	145	107000197	107000198
26	4000	>80	3218	124	184	1270	100	1230	145	107000208	107000209
33	3000	>80	3787	115	184	1570	100	1530	145	107000199	107000200
33	4000	>80	4084	124	184	1570	100	1530	145	107000211	107000212
24	3000	>80	2760	115	184	660	100	630	145	107000187	107000188
24	4000	>80	2976	124	184	660	100	630	145	107000213	107000214
48	3000	>80	5520	115	184	1270	100	1230	145	107000201	107000202
48	4000	>80	5952	124	184	1270	100	1230	145	107000215	107000216
60	3000	>80	6900	115	184	1570	100	1530	145	107000203	107000204
60	4000	>80	7440	124	184	1570	100	1530	145	107000217	107000218

Maggiori informazioni sui controsoffitti a pag. 124-125 / More information regarding false ceiling on page 124-125
 I) Il flusso effettivo potrebbe avere una tolleranza del ±10%. / The effective flux could have a tolerance of ±10%.

AT/284



Caratteristiche tecniche

Technical Characteristics

Corpo	Lamiera di acciaio	Body	Sheet-steel
Colore	○ Bianco opaco (RAL9003)	Colour	○ Matt white (RAL9003)
Gruppo ottico	<ul style="list-style-type: none"> PMO - policarbonato microprismatico (UGR<19) MOT - metacrilato opale 	Optical group	<ul style="list-style-type: none"> PMO - microprismatic polycarbonate (UGR<19) MOT - opal methacrylate
Cablaggio	<ul style="list-style-type: none"> LED ON/OFF con driver integrato LED DALI con driver integrato <p><u>Su richiesta:</u></p> <ul style="list-style-type: none"> Kit di EMERGENZA (autonomia 1/3 h) 	Wiring	<ul style="list-style-type: none"> LED ON/OFF with integrated driver LED DALI with integrated driver <p><u>On request:</u></p> <ul style="list-style-type: none"> EMERGENCY kit (1/3 h autonomy)
Grado di protezione	<ul style="list-style-type: none"> IP 40/20 	Protection degree	<ul style="list-style-type: none"> IP 40/20

Sorgenti LED

LED sources

IRC	<ul style="list-style-type: none"> >80 <p><u>Su richiesta:</u></p> <ul style="list-style-type: none"> >90 	CRI	<ul style="list-style-type: none"> >80 <p><u>On request:</u></p> <ul style="list-style-type: none"> >90
Temp. colore	<ul style="list-style-type: none"> 3000 K 4000 K <p><u>Su richiesta:</u></p> <ul style="list-style-type: none"> TUNABLE WHITE 2700-6500 K 	Colour Temp.	<ul style="list-style-type: none"> 3000 K 4000 K <p><u>On request:</u></p> <ul style="list-style-type: none"> TUNABLE WHITE 2700-6500 K

Ottiche

Diffusers

PMO

Diffusore in policarbonato microprismatico anabbagliante. Valori di luminanza < 3000 cd/m² per angoli > 65°. Film interno in policarbonato opale anabbagliante per una maggiore uniformità luminosa. Conforme ad essere installata in ambienti con uso di videoterminali secondo la norma UNI EN 12464-1.

Diffuser made of anti-glare microprismatic polycarbonate. Luminance values <3000 cd/m² for angles >65°. Internal anti-glare opal polycarbonate film for a better light uniformity. Suitable for installation in workplaces with the use of video terminals according to EN 12464-1 standard.

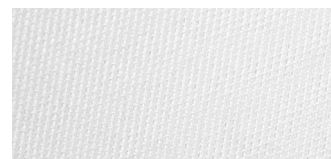
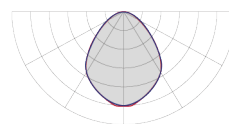

MOT

Diffusore in metacrilato opale ad alta trasmittanza, ideale per una distribuzione uniforme.

Diffuser in opal methacrylate with high transmittance, ideal for uniform distribution.

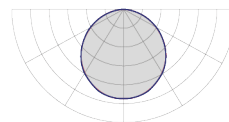

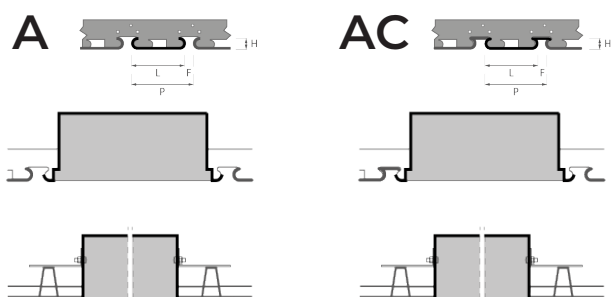

P [mm]	100	150
L [mm]	85	135
F [mm]	15	15
H [mm]	16	16

P [mm]	100	150
L [mm]	85	135
F [mm]	15	15
H [mm]	16	16

Accessori (da ordinare separatamente)
Accessories (to be ordered separately)

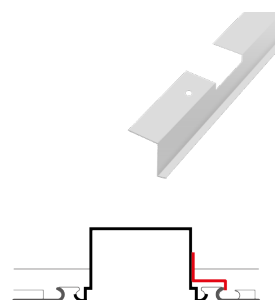

COPRIFUGA LATERALE
SIDE COVER

Cod. / Code CF00X
 Acciaio preverniciato bianco. Viti fornite in dotazione
 White pre-painted steel. Fixing screws included.

- **1**: L = 660mm
- **2**: L = 1270mm
- **3**: L = 1570mm

PMO

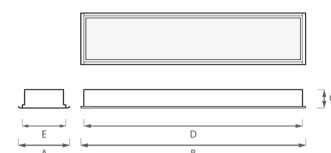
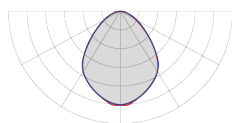

Potenza Power [W]	Temp. colore Colour Temp. [K]	IRC CRI	Flusso lum. Lum. flux [lm]	Efficienza lum. Lum. effic. [lm / W]	Dimensioni / Dimensions [mm]					Cod. / Code LED	Cod. / Code LED DALI
					A	B	C	D	E		
24	3000	>80	2904	121	284	660	100	630	245	109000126	109000128
24	4000	>80	3144	131	284	660	100	630	245	109000130	109000132
48	3000	>80	5808	121	284	1270	100	1230	245	109000134	109000136
48	4000	>80	6288	131	284	1270	100	1230	245	109000138	109000140
60	3000	>80	7260	121	284	1570	100	1530	245	109000141	109000143
60	4000	>80	7860	131	284	1570	100	1530	245	109000145	109000147

MOT

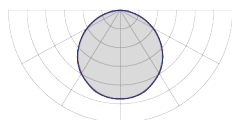

Potenza Power [W]	Temp. colore Colour Temp. [K]	IRC CRI	Flusso lum. Lum. flux [lm]	Efficienza lum. Lum. effic. [lm / W]	Dimensioni / Dimensions [mm]					Cod. / Code LED	Cod. / Code LED DALI
					A	B	C	D	E		
24	3000	>80	2760	115	284	660	100	630	245	109000127	109000129
24	4000	>80	2976	124	284	660	100	630	245	109000131	109000133
48	3000	>80	5520	115	284	1270	100	1230	245	109000135	109000137
48	4000	>80	5952	124	284	1270	100	1230	245	109000139	109000149
60	3000	>80	6900	115	284	1570	100	1530	245	109000142	109000144
60	4000	>80	7440	124	284	1570	100	1530	245	109000146	109000148

Maggiori informazioni sui controsoffitti a pag. 124-125 / More information regarding false ceiling on page 124-125
 I) Il flusso effettivo potrebbe avere una tolleranza del ±10%. / The effective flux could have a tolerance of ±10%.

AT/20



Caratteristiche tecniche

Technical Characteristics

Corpo	Lamiera di acciaio	Body	Sheet-steel
Colore	○ Bianco opaco (RAL9003)	Colour	○ Matt white (RAL9003)
Gruppo ottico	<ul style="list-style-type: none"> PMO - policarbonato microprismatico (UGR<19) MOT - metacrilato opale 	Optical group	<ul style="list-style-type: none"> PMO - microprismatic polycarbonate (UGR<19) MOT - opal methacrylate
Cablaggio	<ul style="list-style-type: none"> LED ON/OFF con driver integrato LED DALI con driver integrato <p><u>Su richiesta:</u></p> <ul style="list-style-type: none"> Kit di EMERGENZA (autonomia 1/3 h) 	Wiring	<ul style="list-style-type: none"> LED ON/OFF with integrated driver LED DALI with integrated driver <p><u>On request:</u></p> <ul style="list-style-type: none"> EMERGENCY kit (1/3 h autonomy)
Grado di protezione	<ul style="list-style-type: none"> IP 40/20 	Protection degree	<ul style="list-style-type: none"> IP 40/20

Sorgenti LED

LED sources

IRC	>80 <u>Su richiesta:</u> >90	CRI	>80 <u>On request:</u> >90
Temp. colore	<ul style="list-style-type: none"> 3000 K 4000 K <p><u>Su richiesta:</u></p> <ul style="list-style-type: none"> TUNABLE WHITE 2700-6500 K 	Colour Temp.	<ul style="list-style-type: none"> 3000 K 4000 K <p><u>On request:</u></p> <ul style="list-style-type: none"> TUNABLE WHITE 2700-6500 K

Ottiche

Diffusers

PMO

Diffusore in policarbonato microprismatico anabbagliante. Valori di luminanza < 3000 cd/m² per angoli > 65°. Film interno in policarbonato opale anabbagliante per una maggiore uniformità luminosa. Conforme ad essere installata in ambienti con uso di videoterminali secondo la norma UNI EN 12464-1.

Diffuser made of anti-glare microprismatic polycarbonate. Luminance values <3000 cd/m² for angles >65°. Internal anti-glare opal polycarbonate film for a better light uniformity. Suitable for installation in workplaces with the use of video terminals according to EN 12464-1 standard.

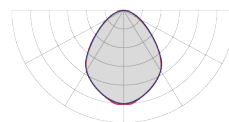

UGR
<19

MOT

Diffusore in metacrilato opale ad alta trasmittanza, ideale per una distribuzione uniforme.

Diffuser in opal methacrylate with high transmittance, ideal for uniform distribution.

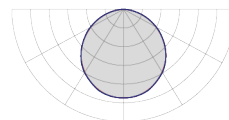

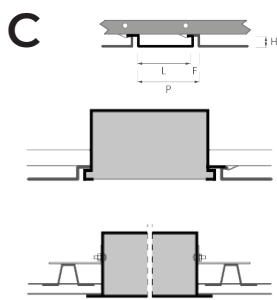

P [mm]	100	200
L [mm]	90	190
F [mm]	10	10
H [mm]	17	17

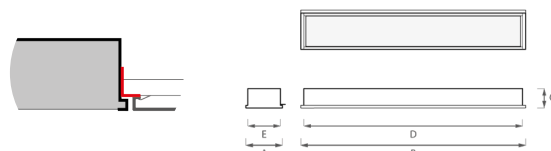

PMO

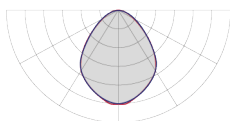

Potenza Power [W]	Temp. colore Colour Temp. [K]	IRC CRI	Flusso lum. Lum. flux [lm]	Efficienza lum. Lum. effic. [lm / W]	Dimensioni / Dimensions [mm]					Cod. / Code LED	Cod. / Code LED DALI
					A	B	C	D	E		
13	3000	>80	1573	121	190	654	100	620	170	104000239	104000245
13	4000	>80	1703	131	190	654	100	620	170	104000251	104000257
26	3000	>80	3146	121	190	1264	100	1220	170	104000241	104000247
26	4000	>80	3406	131	190	1264	100	1220	170	104000253	104000259
33	3000	>80	3993	121	190	1564	100	1520	170	104000243	104000249
33	4000	>80	4323	131	190	1564	100	1520	170	104000255	104000261
24	3000	>80	2904	121	190	654	100	620	170	104000240	104000246
24	4000	>80	3144	131	190	654	100	620	170	104000252	104000258
48	3000	>80	5808	121	190	1264	100	1220	170	104000242	104000248
48	4000	>80	6288	131	190	1264	100	1220	170	104000254	104000260
60	3000	>80	7260	121	190	1564	100	1520	170	104000244	104000250
60	4000	>80	7860	131	190	1564	100	1520	170	104000256	104000262

MOT

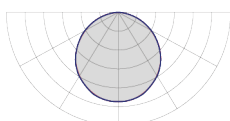

Potenza Power [W]	Temp. colore Colour Temp. [K]	IRC CRI	Flusso lum. Lum. flux [lm]	Efficienza lum. Lum. effic. [lm / W]	Dimensioni / Dimensions [mm]					Cod. / Code LED	Cod. / Code LED DALI
					A	B	C	D	E		
13	3000	>80	1495	115	190	654	100	620	170	104000275	104000276
13	4000	>80	1612	124	190	654	100	620	170	104000263	104000269
26	3000	>80	2990	115	190	1264	100	1220	170	104000279	104000280
26	4000	>80	3224	124	190	1264	100	1220	170	104000265	104000271
33	3000	>80	3795	115	190	1564	100	1520	170	104000283	104000284
33	4000	>80	4092	124	190	1564	100	1520	170	104000267	104000273
24	3000	>80	2760	115	190	654	100	620	170	104000277	104000278
24	4000	>80	2976	124	190	654	100	620	170	104000264	104000270
48	3000	>80	5520	115	190	1264	100	1220	170	104000281	104000282
48	4000	>80	5952	124	190	1264	100	1220	170	104000266	104000272
60	3000	>80	6900	115	190	1564	100	1520	170	104000285	104000286
60	4000	>80	7440	124	190	1564	100	1520	170	104000268	104000274

AT/C 230



Caratteristiche tecniche

Technical Characteristics

Corpo	Lamiera di acciaio	Body	Sheet-steel
Colore	○ Bianco opaco (RAL9003)	Colour	○ Matt white (RAL9003)
Gruppo ottico	<ul style="list-style-type: none"> PMO - policarbonato microprismatico (UGR<19) MOT - metacrilato opale 	Optical group	<ul style="list-style-type: none"> PMO - microprismatic polycarbonate (UGR<19) MOT - opal methacrylate
Cablaggio	<ul style="list-style-type: none"> LED ON/OFF con driver integrato LED DALI con driver integrato <p><u>Su richiesta:</u></p> <ul style="list-style-type: none"> Kit di EMERGENZA (autonomia 1/3 h) 	Wiring	<ul style="list-style-type: none"> LED ON/OFF with integrated driver LED DALI with integrated driver <p><u>On request:</u></p> <ul style="list-style-type: none"> EMERGENCY kit (1/3 h autonomy)
Grado di protezione	<ul style="list-style-type: none"> IP 40/20 	Protection degree	<ul style="list-style-type: none"> IP 40/20

Sorgenti LED

LED sources

IRC	<ul style="list-style-type: none"> >80 <p><u>Su richiesta:</u></p> <ul style="list-style-type: none"> >90 	CRI	<ul style="list-style-type: none"> >80 <p><u>On request:</u></p> <ul style="list-style-type: none"> >90
Temp. colore	<ul style="list-style-type: none"> 3000 K 4000 K <p><u>Su richiesta:</u></p> <ul style="list-style-type: none"> TUNABLE WHITE 2700-6500 K 	Colour Temp.	<ul style="list-style-type: none"> 3000 K 4000 K <p><u>On request:</u></p> <ul style="list-style-type: none"> TUNABLE WHITE 2700-6500 K

Ottiche

Diffusers

PMO

Diffusore in policarbonato microprismatico anabbagliante. Valori di luminanza < 3000 cd/m² per angoli > 65°. Film interno in policarbonato opale anabbagliante per una maggiore uniformità luminosa. Conforme ad essere installata in ambienti con uso di videoterminali secondo la norma UNI EN 12464-1.

Diffuser made of anti-glare microprismatic polycarbonate. Luminance values <3000 cd/m² for angles >65°. Internal anti-glare opal polycarbonate film for a better light uniformity. Suitable for installation in workplaces with the use of video terminals according to EN 12464-1 standard.

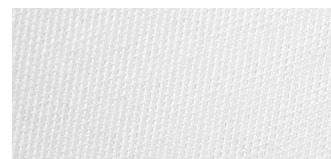
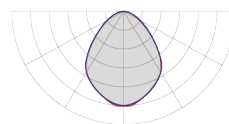

MOT

Diffusore in metacrilato opale ad alta trasmittanza, ideale per una distribuzione uniforme.

Diffuser in opal methacrylate with high transmittance, ideal for uniform distribution.

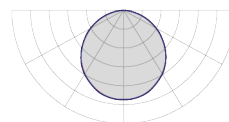

Tipologia di installazione

Type of installation

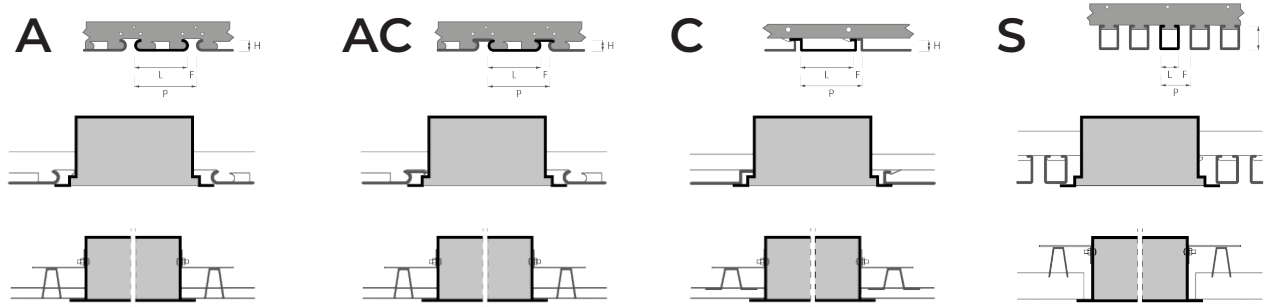

P [mm]	100	200
L [mm]	85	185
F [mm]	15	15
H [mm]	16	16

P [mm]	100	200
L [mm]	85	185
F [mm]	15	15
H [mm]	16	16

P [mm]	100	200
L [mm]	90	190
F [mm]	10	10
H [mm]	17	17

P [mm]	50	100	200
L [mm]	30	80	180
F [mm]	20	20	20
H [mm]	38	15	15

CARTONGESSO

Plasterboard



Controsoffitto in cartongesso.

L'installazione dei corpi illuminanti avviene tramite molle di fissaggio regolabili. Si consiglia la pendinatura di sicurezza al solaio.

Plasterboard false ceiling.

The installation of the lighting fittings occurs by adjustable fixing springs. Safe anchoring on the concrete slab recommended.

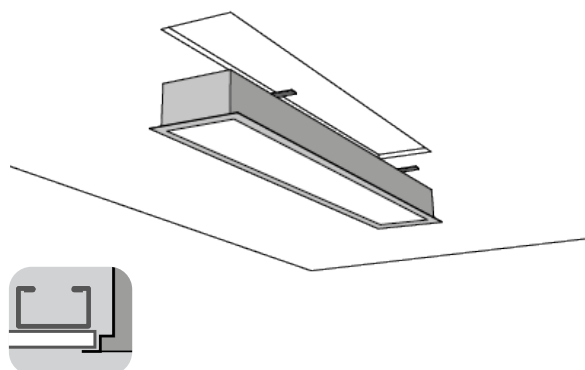

177mm x 622mm
177mm x 1232mm
177mm x 1532mm

PMO

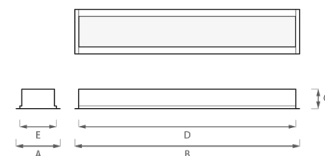
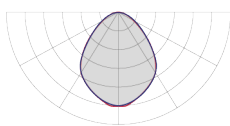

Potenza Power [W]	Temp. colore Colour Temp. [K]	IRC CRI	Flusso lum. Lum. flux [lm]	Efficienza lum. Lum. effic. [lm / W]	Dimensioni / Dimensions [mm]						Cod. / Code LED	Cod. / Code LED DALI
					A	B	C	D	E			
13	3000	>80	1573	121	230	660	90	620	175	177x622	281000173	281000175
13	4000	>80	1703	131	230	660	90	620	175	177x622	281000174	281000176
26	3000	>80	3146	121	230	1270	90	1230	175	177x1232	281000189	281000191
26	4000	>80	3406	131	230	1270	90	1230	175	177x1232	281000190	281000192
33	3000	>80	3993	121	230	1570	90	1530	175	177x1532	281000253	281000256
33	4000	>80	4323	131	230	1570	90	1530	175	177x1532	281000254	281000255
24	3000	>80	2904	121	230	660	90	620	175	177x622	281000181	281000183
24	4000	>80	3144	131	230	660	90	620	175	177x622	281000182	281000184
48	3000	>80	5808	121	230	1270	90	1230	175	177x1232	281000197	281000199
48	4000	>80	6288	131	230	1270	90	1230	175	177x1232	281000198	281000200
60	3000	>80	7260	121	230	1570	90	1530	175	177x1532	281000260	281000257
60	4000	>80	7860	131	230	1570	90	1530	175	177x1532	281000259	281000258

MOT

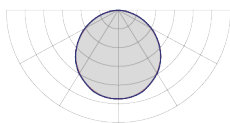

Potenza Power [W]	Temp. colore Colour Temp. [K]	IRC CRI	Flusso lum. Lum. flux [lm]	Efficienza lum. Lum. effic. [lm / W]	Dimensioni / Dimensions [mm]						Cod. / Code LED	Cod. / Code LED DALI
					A	B	C	D	E			
13	3000	>80	1495	115	230	660	90	620	175	177x622	281000132	281000133
13	4000	>80	1612	124	230	660	90	620	175	177x622	281000140	281000141
26	3000	>80	2990	115	230	1270	90	1230	175	177x1232	281000148	281000149
26	4000	>80	3224	124	230	1270	90	1230	175	177x1232	281000156	281000157
33	3000	>80	3795	115	230	1570	90	1530	175	177x1532	281000269	281000272
33	4000	>80	4092	124	230	1570	90	1530	175	177x1532	281000270	281000271
24	3000	>80	2760	115	230	660	90	620	175	177x622	281000136	281000137
24	4000	>80	2976	124	230	660	90	620	175	177x622	281000144	281000145
48	3000	>80	5520	115	230	1270	90	1230	175	177x1232	281000152	281000153
48	4000	>80	5952	124	230	1270	90	1230	175	177x1232	281000160	281000161
60	3000	>80	6900	115	230	1570	90	1530	175	177x1532	281000273	281000276
60	4000	>80	7440	124	230	1570	90	1530	175	177x1532	281000274	281000275



AT/S 180

IP
40/20UGR
<19

Caratteristiche tecniche

Technical Characteristics

Corpo	Lamiera di acciaio	Body	Sheet-steel
Colore	○ Bianco opaco (RAL9003)	Colour	○ Matt white (RAL9003)
Gruppo ottico	<ul style="list-style-type: none"> PMO - policarbonato microprismatico (UGR<19) MOT - metacrilato opale 	Optical group	<ul style="list-style-type: none"> PMO - microprismatic polycarbonate (UGR<19) MOT - opal methacrylate
Cablaggio	<ul style="list-style-type: none"> LED ON/OFF con driver integrato LED DALI con driver integrato <p><u>Su richiesta:</u></p> <ul style="list-style-type: none"> Kit di EMERGENZA (autonomia 1/3 h) 	Wiring	<ul style="list-style-type: none"> LED ON/OFF with integrated driver LED DALI with integrated driver <p><u>On request:</u></p> <ul style="list-style-type: none"> EMERGENCY kit (1/3 h autonomy)
Grado di protezione	<ul style="list-style-type: none"> IP 40/20 	Protection degree	<ul style="list-style-type: none"> IP 40/20

Sorgenti LED

LED sources

IRC	>80 <u>Su richiesta:</u> >90	CRI	>80 <u>On request:</u> >90
Temp. colore	<ul style="list-style-type: none"> 3000 K 4000 K <p><u>Su richiesta:</u></p> <ul style="list-style-type: none"> TUNABLE WHITE 2700-6500 K 	Colour Temp.	<ul style="list-style-type: none"> 3000 K 4000 K <p><u>On request:</u></p> <ul style="list-style-type: none"> TUNABLE WHITE 2700-6500 K

Ottiche

Diffusers

PMO

Diffusore in policarbonato microprismatico anabbagliante. Valori di luminanza < 3000 cd/m² per angoli > 65°. Film interno in policarbonato opale anabbagliante per una maggiore uniformità luminosa. Conforme ad essere installata in ambienti con uso di videoterminali secondo la norma UNI EN 12464-1.

Diffuser made of anti-glare microprismatic polycarbonate. Luminance values <3000 cd/m² for angles >65°. Internal anti-glare opal polycarbonate film for a better light uniformity. Suitable for installation in workplaces with the use of video terminals according to EN 12464-1 standard.

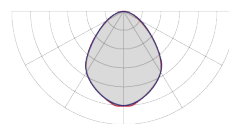
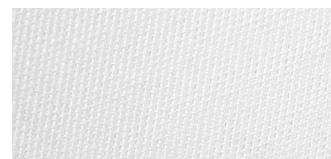
UGR
<19

MOT

Diffusore in metacrilato opale ad alta trasmittanza, ideale per una distribuzione uniforme.

Diffuser in opal methacrylate with high transmittance, ideal for uniform distribution.

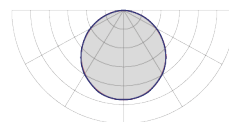

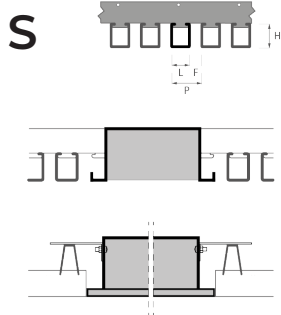

P [mm]	50	100	200
L [mm]	30	80	180
F [mm]	20	20	20
H [mm]	38	15	15

PMO

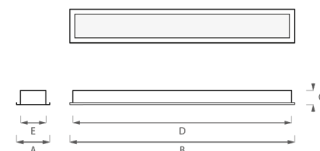
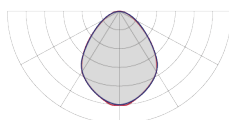

Potenza Power [W]	Temp. colore Colour Temp. [K]	IRC CRI	Flusso lum. Lum. flux [lm]	Efficienza lum. Lum. effic. [lm / W]	Dimensioni / Dimensions [mm]					Cod. / Code LED	Cod. / Code LED DALI
					A	B	C	D	E		
13	3000	>80	1572	121	180	660	85	610	150	111000037	111000038
13	4000	>80	1695	131	180	660	85	610	150	111000039	111000040
26	3000	>80	3143	121	180	1220	85	1170	150	111000041	111000042
26	4000	>80	3390	131	180	1220	85	1170	150	111000043	111000044
33	3000	>80	3989	121	180	1500	85	1450	150	111000045	111000046
33	4000	>80	4302	131	180	1500	85	1450	150	111000047	111000048
24	3000	>80	2904	121	180	660	85	610	150	111000049	111000050
24	4000	>80	3144	131	180	660	85	610	150	111000051	111000052
48	3000	>80	5808	121	180	1220	85	1170	150	111000053	111000054
48	4000	>80	6288	131	180	1220	85	1170	150	111000055	111000056
60	3000	>80	7260	121	180	1500	85	1450	150	111000057	111000058
60	4000	>80	7860	131	180	1500	85	1450	150	111000059	111000060

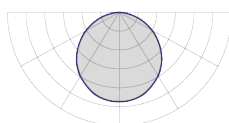

MOT



Potenza Power [W]	Temp. colore Colour Temp. [K]	IRC CRI	Flusso lum. Lum. flux [lm]	Efficienza lum. Lum. effic. [lm / W]	Dimensioni / Dimensions [mm]					Cod. / Code LED	Cod. / Code LED DALI
					A	B	C	D	E		
13	3000	>80	1490	115	180	660	85	610	150	111000013	111000014
13	4000	>80	1609	124	180	660	85	610	150	111000015	111000016
26	3000	>80	2984	115	180	1220	85	1170	150	111000017	111000018
26	4000	>80	3218	124	180	1220	85	1170	150	111000019	111000020
33	3000	>80	3787	115	180	1500	85	1450	150	111000021	111000022
33	4000	>80	4084	124	180	1500	85	1450	150	111000023	111000024
24	3000	>80	2760	115	180	660	85	610	150	111000025	111000026
24	4000	>80	2976	124	180	660	85	610	150	111000027	111000028
48	3000	>80	5520	115	180	1220	85	1170	150	111000029	111000030
48	4000	>80	5952	124	180	1220	85	1170	150	111000031	111000032
60	3000	>80	6900	115	180	1500	85	1450	150	111000033	111000034
60	4000	>80	7440	124	180	1500	85	1450	150	111000035	111000036

1) Il flusso effettivo potrebbe avere una tolleranza del ±10%. / The effective flux could have a tolerance of ±10%.



Street P/30

Incasso | Recessed

IP40 IP65



Caratteristiche tecniche Technical Characteristics

Corpo	Profilo estruso in alluminio	Body	Extruded aluminium profile
Colore	<input checked="" type="radio"/> Alluminio anodizzato <u>Su richiesta:</u> <input type="radio"/> Altri colori	Colour	<input checked="" type="radio"/> Anodized aluminium <u>On request:</u> <input type="radio"/> Other colours available
Gruppo ottico	<ul style="list-style-type: none"> • POL - policarbonato opale 	Optical group	<ul style="list-style-type: none"> • POL - opal polycarbonate
Cablaggio	<ul style="list-style-type: none"> • ⁽¹⁾ LED ON/OFF • ⁽¹⁾ LED DALI <u>Su richiesta:</u> <ul style="list-style-type: none"> • ⁽¹⁾ Circuito RGB 	Wiring	<ul style="list-style-type: none"> • ⁽¹⁾ LED ON/OFF • ⁽¹⁾ LED DALI <u>On request:</u> <ul style="list-style-type: none"> • ⁽¹⁾ RGB circuit
Grado di protezione	IP 40 <u>Su richiesta:</u> <ul style="list-style-type: none"> • IP65 	Protection degree	IP 40 <u>On request:</u> <ul style="list-style-type: none"> • IP65

Sorgenti LED LED sources

IRC	>90 <u>Su richiesta:</u> <ul style="list-style-type: none"> • >80 	CRI	>90 <u>On request:</u> <ul style="list-style-type: none"> • >80
Temp. colore	<ul style="list-style-type: none"> • 3000 K <u>Su richiesta:</u> <ul style="list-style-type: none"> • 4000 K • TUNABLE WHITE 2700-6500 K • LED RGB 	Colour Temp.	<ul style="list-style-type: none"> • 3000 K <u>On request:</u> <ul style="list-style-type: none"> • 4000 K • TUNABLE WHITE 2700-6500 K • RGB LED

Ottiche Diffusers

POL

Diffusore in policarbonato opale a finitura liscia, ideale per una distribuzione uniforme.
Diffuser in opal polycarbonate with smooth finish, ideal for uniform distribution.

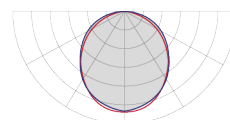

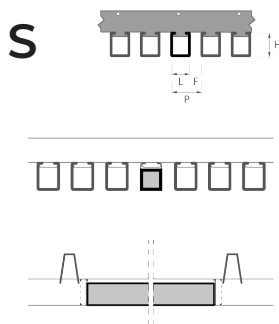

P [mm]	50
L [mm]	30
F [mm]	20
H [mm]	38

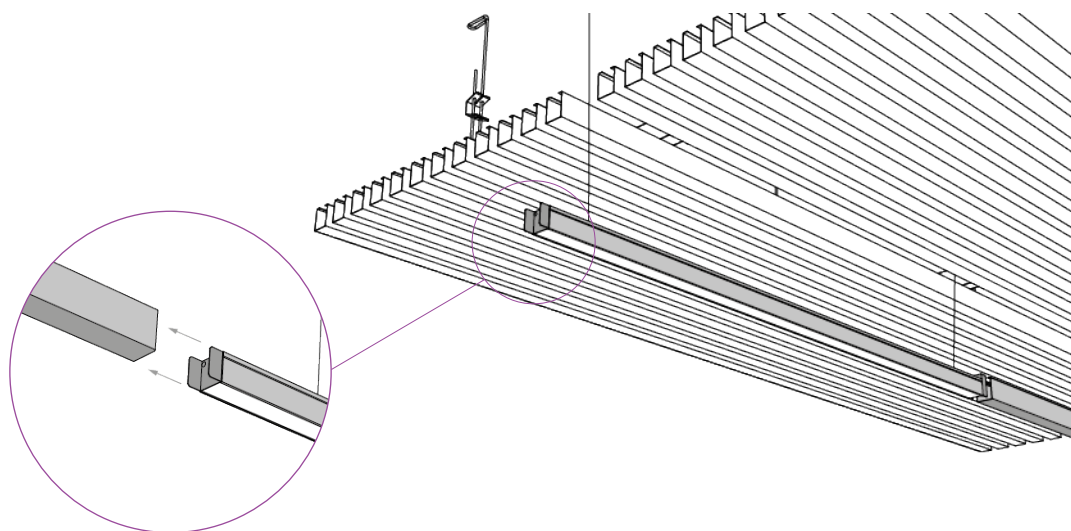

Accessori (da ordinare separatamente)
Accessories (to be ordered separately)



2 pcs.kit

KIT DI ALLINEAMENTO CON DOGHE
SLAT ALIGNMENT KIT
Cod. / Code **KAL703323**
Acciaio preverniciato bianco
Testate di chiusura e relativa minuteria incluse
White prepainted steel
End caps and fixing parts included



2 pcs.kit

KIT DI DISTANZIAMENTO DALLE DOGHE
SLAT DISTANCING KIT
Cod. / Code **KDI703310**
Staffe in acciaio zincato
Galvanized steel brackets

Altri accessori (da ordinare separatamente)
Other accessories (to be ordered separately)

Componenti disassemblati / Disassembled components

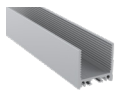

L= 2000 mm

PROFILO
PROFILE
Cod. / Code **70330000x**
Profilo estruso in alluminio
Extruded aluminium profile

- **1**: Colore grigio anodizzato/
Anodized gray colour
- **2**: Colore bianco/
White colour



L= 2000 mm

DIFFUSORE
DIFFUSER
Cod. / Code **DF70332000POL**
Diffusore in policarbonato opale (POL)
Opal polycarbonate diffuser (POL)



2 pcs.kit

TESTATE DI CHIUSURA
END CAPS
Cod. / Code **TC7033x**

- **20**: Colore grigio anodizzato/
Anodized gray colour
- **23**: Colore bianco/
White colour



ALIMENTATORI
DRIVERS
Dettagli tecnici a pag. 142
Technical details from page 142



ROLLE LED
STRIP LED
Dettagli tecnici a pag. 142
Technical details from page 142

Plafone / Ceiling



5 pcs.kit

KIT PLAFONE DA INTERNO
INDOOR CEILING KIT
Cod. / Code **KPR703300**
Staffe in acciaio zincato per profilo di lunghezza L=2000mm, viti di fissaggio incluse
Galvanized steel brackets for L=2000mm profile, screws included



5 pcs.kit

KIT PLAFONE DA ESTERNO
OUTDOOR CEILING KIT
Cod. / Code **KES703300**
Staffe in acciaio INOX per profilo di lunghezza L=2000mm, viti di fissaggio incluse
INOX steel brackets for L=2000mm profile, screws included

Sospensione / Suspension



2 pcs.kit
L= 2000 mm

KIT DI SOSPENSIONE
SUSPENSION KIT
Cod. / Code **KS158**
Cavi metallici di sospensione, relativa minuteria inclusa
Metal cables, fixing parts included



2 pcs.kit

KIT DI FISSAGGIO ORIENTABILE
ADJUSTABLE FIXING KIT
Cod. / Code **KPO703342**
Staffe orientabili in acciaio INOX AISI 304 per profilo L=2000 mm, viti di fissaggio incluse
AISI 304 stainless steel adjustable brackets for L=2000 mm profile, fixing screws included

Parete / Wall

Alimentatori per moduli disassemblati

Drivers for disassembled modules

Incasso | Recessed

		Potenza Power [W]	Tensione in ingresso Lum. effic. [V ; Hz]	Dimensioni / Dimensions [mm]	Cod. / Code
IP20	ON/OFF	20	220-240 ; 50	148 x 45,8 x 22,5	711000013
		50	110-240 ; 50/60	172,2 x 63 x 30	711000015
		75	110-240 ; 50/60	193,2 x 63 x 30	711000016
	DALI	150	220-240 ; 50/60	180 x 65,5 x 31,2	711000042
		35	220-240 ; 50/60 220-240 ; 0	195 x 43 x 30,2	711000044
		60	220-240 ; 50/60 220-240 ; 0	225 x 43 x 30,2	711000045
DMX	100	220-240 ; 50/60 220-240 ; 0	295 x 43 x 29,8	711000046	
	150	220-240 ; 50/60 220-240 ; 0	325 x 43 x 29,8	711000047	
IP67	ON/OFF	55	220-240 ; 50/60	147 x 75 x 39	711000039
		100	110-240 ; 50/60	207 x 76 x 35	711000011
	ON/OFF	20	110-240 ; 50/60 220-240 ; 0	118 x 35 x 26	711000010
		60	110-240 ; 50/60 220-240 ; 0	162,5 x 42,5 x 32	711000018
		100	110-240 ; 50/60 220-240 ; 0	190 x 52 x 37	711000019
		150	110-240 ; 50/60	191 x 63 x 37,5	711000020

Rolle LED per moduli disassemblati

LED Rolls for disassembled modules

		Potenza Power [W / m]	Temp. colore Colour Temp. [K]	IRC CRI	Flusso lum. Lum. flux [lm]	Efficienza lum. Lum. effic. [lm / W]	Voltaggio Voltage [VDC]	Taglio Cut [mm]	Larg. PSB PSB width [mm]	Codice Code	
IP20	STRIP 10W	10	120	3000	>90	835	84	24 VDC	50	8	710000042
		10	120	4000	>90	875	88	24 VDC	50	8	710000043
	STRIP 15W	15	120	3000	>90	1450	97	24 VDC	50	8	710000046
		15	120	4000	>90	1567	104	24 VDC	50	8	710000047
	STRIP 15W HP	15	84	3000	>90	2119	141	24 VDC	83,3	10	710000048
		15	84	4000	>90	2230	149	24 VDC	83,3	10	710000049
	STRIP 15W RGB	15	60	RGB	-	-	-	24 VDC	100	10	710000060
	STRIP 15W RGB+W	15	60	RGB+3000	>80	2075	138	24 VDC	100	10	710000062
		15	60	RGB+4000	>80	2125	142	24 VDC	100	10	710000063
	STRIP 25W	25	204	3000	>90	2355	94	24 VDC	29,4	8	710000052
		25	204	4000	>90	2525	101	24 VDC	29,4	8	710000053
	STRIP 25W HP	25	140	3000	>90	3618	145	24 VDC	50	10	710000056
		25	140	4000	>90	3808	152	24 VDC	50	10	710000057
	STRIP 1W	30	60	2500-6500	>80	2300	77	24 VDC	50	10	710000066

POL

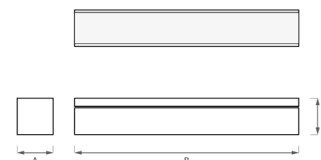
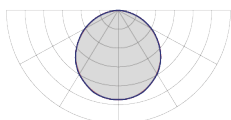

Potenza Power [W]	Temp. colore Colour Temp. [K]	IRC CRI	Flusso lum. Lum. flux [lm]	Efficienza lum. Lum. effic. [lm / W]	Dimensioni / Dimensions [mm]			Cod. / Code LED
					A	B	C	
15	3000	>90	816	54	30	1000	30	713300011
25	3000	>90	1325	53	30	1000	30	713300012
30	3000	>90	1631	54	30	2000	30	713300013
50	3000	>90	2649	53	30	2000	30	713300014



I) Il flusso effettivo potrebbe avere una tolleranza del $\pm 10\%$. / The effective flux could have a tolerance of $\pm 10\%$.
 II) Le dimensioni fanno riferimento al solo modulo, escluse le testate di inizio e fine linea (+2mm cad.). / Dimensions refer to the module without the two end caps (+2mm each).



PLAFONE
e SOSPEN-
SIONE
*CEILING
and SUSPENSION*



Taurus/P

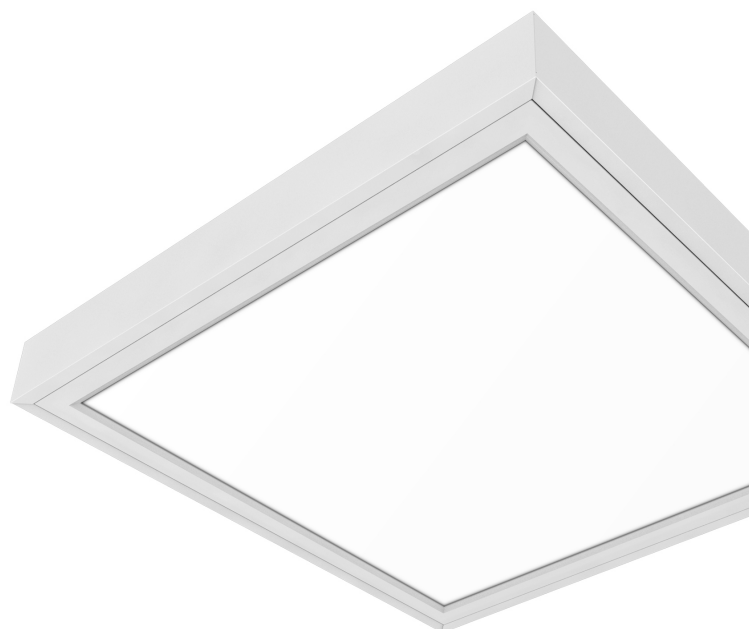
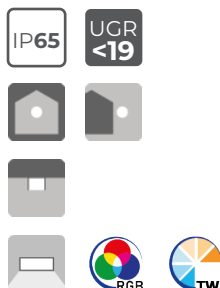

Caratteristiche tecniche

Technical Characteristics

Corpo	Lamiera di acciaio	Body	Sheet-steel
Colore	<ul style="list-style-type: none"> ○ Bianco opaco (RAL 9003) <u>Su richiesta:</u> · Verniciatura anti-microbica 	Colour	<ul style="list-style-type: none"> ○ Matt white (RAL 9003) <u>On request:</u> · Antimicrobial coating
Gruppo ottico	<ul style="list-style-type: none"> · VTR + PMO - vetro temprato e policarbonato microprismatico (UGR<19) · MOT - metacrilato opale 	Optical group	<ul style="list-style-type: none"> · VTR + PMO - tempered glass and microprismatic polycarbonate (UGR<19) · MOT - opal methacrylate
Cablaggio	<ul style="list-style-type: none"> · LED-F ON/OFF con fusibile di protezione, driver integrato · LED-F DALI con fusibile di protezione, driver integrato <u>Su richiesta:</u> · Circuito RGB DMX · Kit di EMERGENZA (autonomia 1/3 h) 	Wiring	<ul style="list-style-type: none"> · LED-F ON/OFF with fused terminal block, integrated driver · LED-F DALI with fused terminal block, integrated driver included <u>On request:</u> · DMX RGB circuit · EMERGENCY kit (1/3 h autonomy)
Grado di protezione	<ul style="list-style-type: none"> · IP 65 	Protection degree	<ul style="list-style-type: none"> · IP 65

Sorgenti LED

LED sources

IRC	<ul style="list-style-type: none"> · >80 · >90 	CRI	<ul style="list-style-type: none"> · >80 · >90
Temp. colore	<ul style="list-style-type: none"> · 4000 K <u>Su richiesta:</u> · 3000 K · 5000 K · TUNABLE WHITE 2700-6500 K · LED RGB 	Colour Temp.	<ul style="list-style-type: none"> · 4000 K <u>On request:</u> · 3000 K · 5000 K · TUNABLE WHITE 2700-6500 K · RGB LED

Ottiche

Diffusers

VTR + PMO

Diffusore in vetro temprato di sicurezza e policarbonato microprismatico. Valori di luminanza < 3000 cd/m² per angoli > 65°. Film interno in policarbonato opale anabbagliante per una maggiore uniformità luminosa. Conforme ad essere installata in ambienti con uso di videoterminali secondo la norma UNI EN 12464-1.

Diffuser made of secure transparent tempered glass and anti-glare microprismatic polycarbonate. Luminance values <3000 cd/m² for angles >65°. Internal anti-glare opal polycarbonate film for a better light uniformity. Suitable for installation in workplaces with the use of video terminals according to EN 12464-1 standard.

MOT

Diffusore in metacrilato opale ad alta trasmittanza, ideale per una distribuzione uniforme.

Diffuser in opal methacrylate with high transmittance, ideal for uniform distribution.

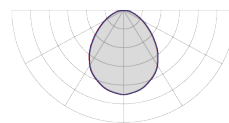

UGR
<19

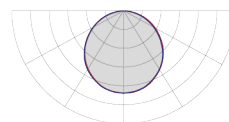

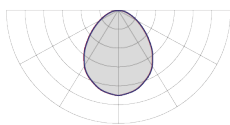
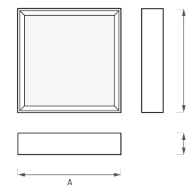

VTR+PMO



Potenza Power [W]	Temp. colore Colour Temp. [K]	IRC CRI	Flusso lum. Lum. flux [lm]	Efficienza lum. Lum. effic. [lm / W]	Dimensioni / Dimensions [mm]			Cod. / Code LED-F	Cod. / Code LED-F DALI
					A	B	C		
38	4000	>80	4180	110	600	600	120	441100021	441100023
38	4000	>90	3344	88	600	600	120	441100025	441100027
44	4000	>80	4840	110	600	600	120	441100029	441100031
44	4000	>90	3872	88	600	600	120	441100033	441100035
50	4000	>80	5500	110	600	600	120	441100037	441100039
50	4000	>90	4400	88	600	600	120	441100041	441100043
78	4000	>80	9516	122	600	600	120	441100045	441100047
78	4000	>90	7644	98	600	600	120	441100049	441100051
52	4000	>80	6344	122	300	1200	120	441100086	441100087
52	4000	>90	5096	98	300	1200	120	441100088	441100089
78	4000	>80	9516	122	300	1200	120	441100090	441100091
78	4000	>90	7644	98	300	1200	120	441100092	441100093
88	4000	>80	9680	110	600	1200	120	441100053	441100055
88	4000	>90	7744	88	600	1200	120	441100057	441100059
100	4000	>80	11000	110	600	1200	120	441100061	441100063
100	4000	>90	8800	88	600	1200	120	441100065	441100067
156	4000	>80	19032	122	600	1200	120	441100069	441100071
156	4000	>90	15288	98	600	1200	120	441100073	441100075

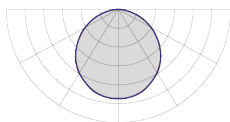

MOT



Potenza Power [W]	Temp. colore Colour Temp. [K]	IRC CRI	Flusso lum. Lum. flux [lm]	Efficienza lum. Lum. effic. [lm / W]	Dimensioni / Dimensions [mm]			Cod. / Code LED	Cod. / Code LED DALI
					A	B	C		
38	4000	>80	4218	111	600	600	120	441100020	441100022
38	4000	>90	3382	89	600	600	120	441100024	441100026
44	4000	>80	4884	111	600	600	120	441100028	441100030
44	4000	>90	3916	89	600	600	120	441100032	441100034
50	4000	>80	5550	111	600	600	120	441100036	441100038
50	4000	>90	4450	89	600	600	120	441100040	441100042
78	4000	>80	9672	124	600	600	120	441100044	441100046
78	4000	>90	7722	99	600	600	120	441100048	441100050
52	4000	>80	6448	124	300	1200	120	441100078	441100079
52	4000	>90	5148	99	300	1200	120	441100080	441100081
78	4000	>80	9672	124	300	1200	120	441100082	441100083
78	4000	>90	7722	99	300	1200	120	441100084	441100085
88	4000	>80	9768	111	600	1200	120	441100052	441100054
88	4000	>90	7832	89	600	1200	120	441100056	441100058
100	4000	>80	11100	111	600	1200	120	441100060	441100062
100	4000	>90	8900	89	600	1200	120	441100064	441100066
156	4000	>80	19344	124	600	1200	120	441100068	441100070
156	4000	>90	15444	99	600	1200	120	441100072	441100074

1) Il flusso effettivo potrebbe avere una tolleranza del ±10%. / The effective flux could have a tolerance of ±10%.

Plan/P

IP40

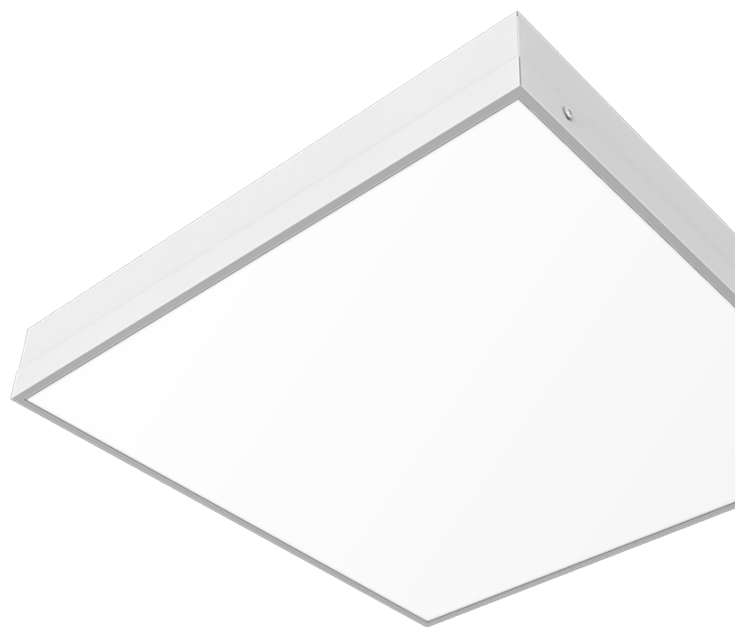
UGR
<19

Caratteristiche tecniche

Technical Characteristics

Corpo	Lamiera di acciaio	Body	Sheet-steel
Colore	<ul style="list-style-type: none"> ○ Bianco opaco (RAL 9003) <u>Su richiesta:</u> <ul style="list-style-type: none"> ● Altri colori 	Colour	<ul style="list-style-type: none"> ○ Matt white (RAL 9003) <u>On request:</u> <ul style="list-style-type: none"> ● Other colours available
Gruppo ottico	<ul style="list-style-type: none"> · PSU - polistirene microprismatico (UGR<19) · MOT - metacrilato opale 	Optical group	<ul style="list-style-type: none"> · PSU - microprismatic polystyrene (UGR<19) · MOT - opal methacrylate
Cablaggio	<ul style="list-style-type: none"> · LED ON/OFF con driver integrato · LED DALI con driver integrato <u>Su richiesta:</u> <ul style="list-style-type: none"> · Circuito RGB DMX · Kit di EMERGENZA (autonomia 1/3 h) 	Wiring	<ul style="list-style-type: none"> · LED ON/OFF with integrated driver · LED DALI with integrated driver <u>On request:</u> <ul style="list-style-type: none"> · DMX RGB circuit · EMERGENCY kit (1/3 h autonomy)
Grado di protezione	<ul style="list-style-type: none"> · IP 40 	Protection degree	<ul style="list-style-type: none"> · IP 40

Sorgenti LED

LED sources

IRC	<ul style="list-style-type: none"> · >80 <u>Su richiesta:</u> <ul style="list-style-type: none"> · >90 	CRI	<ul style="list-style-type: none"> · >80 <u>On request:</u> <ul style="list-style-type: none"> · >90
Temp. colore	<ul style="list-style-type: none"> · 3000 K · 4000 K <u>Su richiesta:</u> <ul style="list-style-type: none"> · TUNABLE WHITE 2700-6500 K · LED RGB 	Colour Temp.	<ul style="list-style-type: none"> · 3000 K · 4000 K <u>On request:</u> <ul style="list-style-type: none"> · TUNABLE WHITE 2700-6500 K · RGB LED

Ottiche

Diffusers

PSU

Diffusore in polistirene microprismatico anabbagliante ad emissione luminosa controllata. Conforme ad essere installata in ambienti con uso di videoterminali secondo la norma UNI EN 12464-1.

Diffuser made of anti-glare microprismatic polystyrene with controlled luminance emission. Suitable for installation in workplaces with the use of video terminals according to EN 12464-1 standard.

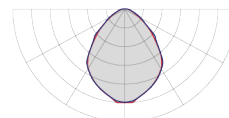
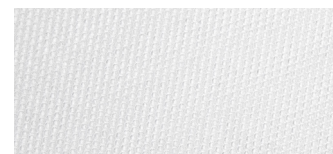
UGR
<19

MOT

Diffusore in metacrilato opale ad alta trasmittanza, ideale per una distribuzione uniforme.

Diffuser in opal methacrylate with high transmittance, ideal for uniform distribution.

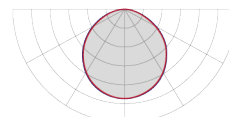

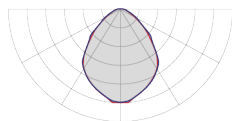
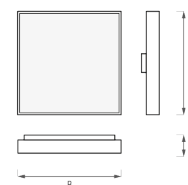

PSU



Potenza Power [W]	Temp. colore Colour Temp. [K]	IRC CRI	Flusso lum. Lum. flux [lm]	Efficienza lum. Lum. effic. [lm / W]	Dimensioni / Dimensions [mm]			Cod. / Code LED	Cod. / Code LED DALI
					A	B	C		
26	3000	>80	3328	128	597	597	100	367000210	367000220
26	4000	>80	3510	135	597	597	100	367000215	367000225
32	3000	>80	4096	128	597	597	100	367000211	367000221
32	4000	>80	4320	135	597	597	100	367000216	367000226
38	3000	>80	4864	128	597	597	100	367000212	367000222
38	4000	>80	5130	135	597	597	100	367000217	367000227
44	3000	>80	5632	128	597	597	100	367000213	367000223
44	4000	>80	5940	135	597	597	100	367000218	367000228
50	3000	>80	6400	128	597	597	100	367000214	367000224
50	4000	>80	6750	135	597	597	100	367000219	367000229
38	3000	>80	4864	128	297	1197	100	367000230	367000236
38	4000	>80	5130	135	297	1197	100	367000233	367000239
44	3000	>80	5632	128	297	1197	100	367000231	367000237
44	4000	>80	5940	135	297	1197	100	367000234	367000240
50	3000	>80	6400	128	297	1197	100	367000232	367000238
50	4000	>80	6750	135	297	1197	100	367000235	367000241

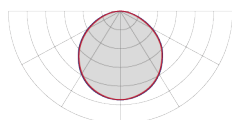

MOT



Potenza Power [W]	Temp. colore Colour Temp. [K]	IRC CRI	Flusso lum. Lum. flux [lm]	Efficienza lum. Lum. effic. [lm / W]	Dimensioni / Dimensions [mm]			Cod. / Code LED	Cod. / Code LED DALI
					A	B	C		
26	3000	>80	3016	116	597	597	100	367000178	367000188
26	4000	>80	3172	122	597	597	100	367000183	367000193
32	3000	>80	3712	116	597	597	100	367000179	367000189
32	4000	>80	3904	122	597	597	100	367000184	367000194
38	3000	>80	4408	116	597	597	100	367000180	367000190
38	4000	>80	4636	122	597	597	100	367000185	367000195
44	3000	>80	5104	116	597	597	100	367000181	367000191
44	4000	>80	5368	122	597	597	100	367000186	367000196
50	3000	>80	5800	116	597	597	100	367000182	367000192
50	4000	>80	6100	122	597	597	100	367000187	367000197
38	3000	>80	4408	116	297	1197	100	367000198	367000204
38	4000	>80	4636	122	297	1197	100	367000201	367000207
44	3000	>80	5104	116	297	1197	100	367000199	367000205
44	4000	>80	5368	122	297	1197	100	367000202	367000208
50	3000	>80	5800	116	297	1197	100	367000200	367000206
50	4000	>80	6100	122	297	1197	100	367000203	367000209

1) Il flusso effettivo potrebbe avere una tolleranza del ±10%. / The effective flux could have a tolerance of ±10%.

Manta/P



Caratteristiche tecniche

Technical Characteristics

Corpo	Lamiera di acciaio	Body	Sheet-steel
Colore	<ul style="list-style-type: none"> ○ Bianco opaco (RAL 9003) <u>Su richiesta:</u> <ul style="list-style-type: none"> ● Altri colori 	Colour	<ul style="list-style-type: none"> ○ Matt white (RAL 9003) <u>On request:</u> <ul style="list-style-type: none"> ● Other colours available
Gruppo ottico	<ul style="list-style-type: none"> · PMO - policarbonato microprismatico (UGR<19) 	Optical group	<ul style="list-style-type: none"> · PMO - microprismatic polycarbonate (UGR<19)
Cablaggio	<ul style="list-style-type: none"> · LED ON/OFF con driver integrato · LED DALI con driver integrato <u>Su richiesta:</u> <ul style="list-style-type: none"> · Kit di EMERGENZA (autonomia 1/3 h) 	Wiring	<ul style="list-style-type: none"> · LED ON/OFF with integrated driver · LED DALI with integrated driver <u>On request:</u> <ul style="list-style-type: none"> · EMERGENCY kit (1/3 h autonomy)
Grado di protezione	<ul style="list-style-type: none"> · IP 40 	Protection degree	<ul style="list-style-type: none"> · IP 40

Sorgenti LED

LED sources

IRC	<ul style="list-style-type: none"> · >80 <u>Su richiesta:</u> <ul style="list-style-type: none"> · >90 	CRI	<ul style="list-style-type: none"> · >80 <u>On request:</u> <ul style="list-style-type: none"> · >90
Temp. colore	<ul style="list-style-type: none"> · 3000 K · 4000 K <u>Su richiesta:</u> <ul style="list-style-type: none"> · TUNABLE WHITE 2700-6500 K 	Colour Temp.	<ul style="list-style-type: none"> · 3000 K · 4000 K <u>On request:</u> <ul style="list-style-type: none"> · TUNABLE WHITE 2700-6500 K

Ottiche Diffusers

PMO

Diffusore in policarbonato microprismatico anabbagliante. Valori di luminanza < 3000 cd/m² per angoli > 65°. Film interno in policarbonato opale anabbagliante per una maggiore uniformità luminosa. Conforme ad essere installata in ambienti con uso di videotermini secondo la norma UNI EN 12464-1.

Diffuser made of anti-glare microprismatic polycarbonate. Luminance values <3000 cd/m² for angles >65°. Internal anti-glare opal polycarbonate film for a better light uniformity. Suitable for installation in workplaces with the use of video terminals according to EN 12464-1 standard.

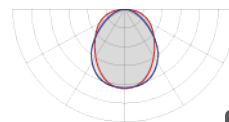

UGR <19

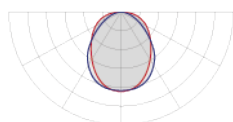
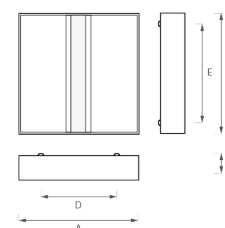
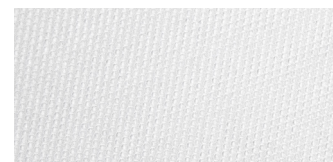

PMO



Potenza Power [W]	Temp. colore Colour Temp. [K]	IRC CRI	Flusso lum. Lum. flux [lm]	Efficienza lum. Lum. effic. [lm / W]	Dimensioni / Dimensions [mm]					Cod. / Code LED	Cod. / Code LED DALI
					A	B	C	D	E		
42	3000	>80	3570	85	620	620	127	390	510	330100001	330100004
42	4000	>80	3906	93	620	620	127	390	510	330100007	330100010
50	3000	>80	4250	85	620	620	127	390	510	330100002	330100005
50	4000	>80	4650	93	620	620	127	390	510	330100008	330100011
64	3000	>80	5440	85	620	620	127	390	510	330100003	330100006
64	4000	>80	5952	93	620	620	127	390	510	330100009	330100012
63	3000	>80	5355	85	320	1220	127	120	1110	330100013	330100015
63	4000	>80	5859	93	320	1220	127	120	1110	330100014	330100016

I) Il flusso effettivo potrebbe avere una tolleranza del ±10%. / The effective flux could have a tolerance of ±10%.

Duoled/P

IP40 UGR <19



Caratteristiche tecniche

Technical Characteristics

Corpo	Lamiera di acciaio	Body	Sheet-steel
Colore	<ul style="list-style-type: none"> ○ Bianco opaco (RAL 9003) <p><u>Su richiesta:</u></p> <ul style="list-style-type: none"> ● Altri colori 	Colour	<ul style="list-style-type: none"> ○ Matt white (RAL 9003) <p><u>On request:</u></p> <ul style="list-style-type: none"> ● Other colours available
Gruppo ottico	<ul style="list-style-type: none"> · PMO - policarbonato microprismatico (UGR<19) · MOT - metacrilato opale 	Optical group	<ul style="list-style-type: none"> · PMO - microprismatic polycarbonate (UGR<19) · MOT - opal methacrylate
Cablaggio	<ul style="list-style-type: none"> · LED ON/OFF con driver integrato · LED DALI con driver integrato <p><u>Su richiesta:</u></p> <ul style="list-style-type: none"> · Kit di EMERGENZA (autonomia 1/3 h) 	Wiring	<ul style="list-style-type: none"> · LED ON/OFF with integrated driver · LED DALI with integrated driver <p><u>On request:</u></p> <ul style="list-style-type: none"> · EMERGENCY kit (1/3 h autonomy)
Grado di protezione	<ul style="list-style-type: none"> · IP 40 	Protection degree	<ul style="list-style-type: none"> · IP 40

Sorgenti LED

LED sources

IRC	<ul style="list-style-type: none"> · >80 <p><u>Su richiesta:</u></p> <ul style="list-style-type: none"> · >90 	CRI	<ul style="list-style-type: none"> · >80 <p><u>On request:</u></p> <ul style="list-style-type: none"> · >90
Temp. colore	<ul style="list-style-type: none"> · 3000 K · 4000 K <p><u>Su richiesta:</u></p> <ul style="list-style-type: none"> · TUNABLE WHITE 2700-6500 K 	Colour Temp.	<ul style="list-style-type: none"> · 3000 K · 4000 K <p><u>On request:</u></p> <ul style="list-style-type: none"> · TUNABLE WHITE 2700-6500 K

Ottiche

Diffusers

PMO

Diffusore in policarbonato microprismatico anabbagliante. Valori di luminanza < 3000 cd/m² per angoli > 65°. Film interno in policarbonato opale anabbagliante per una maggiore uniformità luminosa. Conforme ad essere installata in ambienti con uso di videoterminali secondo la norma UNI EN 12464-1.

Diffuser made of anti-glare microprismatic polycarbonate. Luminance values <3000 cd/m² for angles >65°. Internal anti-glare opal polycarbonate film for a better light uniformity. Suitable for installation in workplaces with the use of video terminals according to EN 12464-1 standard.

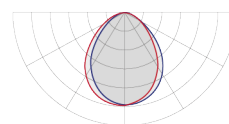

UGR <19

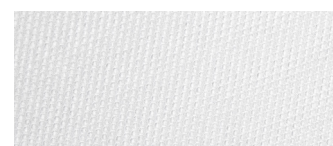

MOT

Diffusore in metacrilato opale ad alta trasmittanza, ideale per una distribuzione uniforme.

Diffuser in opal methacrylate with high transmittance, ideal for uniform distribution.

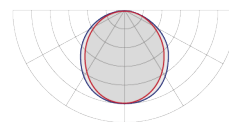

PMO

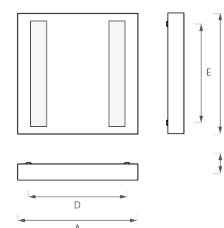
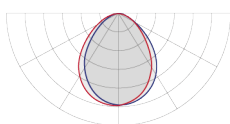

Potenza Power [W]	Temp. colore Colour Temp. [K]	IRC CRI	Flusso lum. Lum. flux [lm]	Efficienza lum. Lum. effic. [lm / W]	Dimensioni / Dimensions [mm]					Cod. / Code LED	Cod. / Code LED DALI
					A	B	C	D	E		
26	3000	>80	3172	122	620	620	82	540	540	352400165	352400166
26	4000	>80	3406	131	620	620	82	540	540	352400167	352400168
32	3000	>80	3904	122	620	620	82	540	540	352400169	352400170
32	4000	>80	4192	131	620	620	82	540	540	352400171	352400172
40	3000	>80	4880	122	620	620	82	540	540	352400173	352400174
40	4000	>80	5240	131	620	620	82	540	540	352400175	352400176
48	3000	>80	5856	122	620	620	82	540	540	352400177	352400178
48	4000	>80	6288	131	620	620	82	540	540	352400179	352400180

MOT

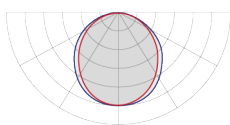

Potenza Power [W]	Temp. colore Colour Temp. [K]	IRC CRI	Flusso lum. Lum. flux [lm]	Efficienza lum. Lum. effic. [lm / W]	Dimensioni / Dimensions [mm]					Cod. / Code LED	Cod. / Code LED DALI
					A	B	C	D	E		
26	3000	>80	2990	115	620	620	82	540	540	352400149	352400150
26	4000	>80	3224	124	620	620	82	540	540	352400151	352400152
32	3000	>80	3680	115	620	620	82	540	540	352400153	352400154
32	4000	>80	3968	124	620	620	82	540	540	352400155	352400156
40	3000	>80	4600	115	620	620	82	540	540	352400157	352400158
40	4000	>80	4960	124	620	620	82	540	540	352400159	352400160
48	3000	>80	5520	115	620	620	82	540	540	352400161	352400162
48	4000	>80	5952	124	620	620	82	540	540	352400163	352400164

1) Il flusso effettivo potrebbe avere una tolleranza del ±10%. / The effective flux could have a tolerance of ±10%.

Slim/P

IP20 UGR <19

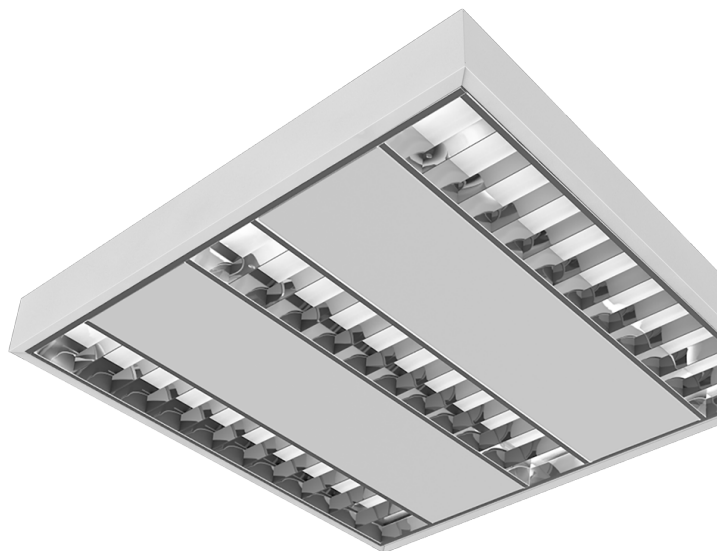

2x

3x

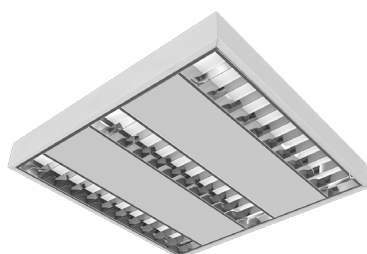
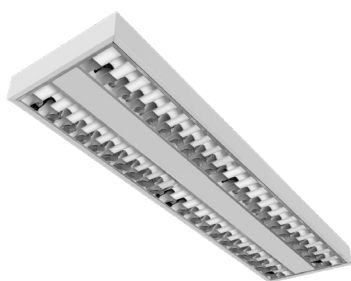

Caratteristiche tecniche

Technical Characteristics

Corpo	Lamiera di acciaio	Body	Sheet-steel
Colore	○ Bianco opaco (RAL 9003) <u>Su richiesta:</u> ● Altri colori	Colour	○ Matt white (RAL 9003) <u>On request:</u> ● Other colours available
Gruppo ottico	· DLM - darklight (UGR<19)	Optical group	· DLM - darklight (UGR<19)
Cablaggio	· LED ON/OFF con driver integrato · LED DALI con driver integrato <u>Su richiesta:</u> · Kit di EMERGENZA (autonomia 1/3 h)	Wiring	· LED ON/OFF with integrated driver · LED DALI with integrated driver <u>On request:</u> · EMERGENCY kit (1/3 h autonomy)
Grado di protezione	· IP 20	Protection degree	· IP 20

Sorgenti LED

LED sources



IRC	· >80 <u>Su richiesta:</u> · >90	CRI	· >80 <u>On request:</u> · >90
Temp. colore	· 3000 K · 4000 K <u>Su richiesta:</u> · TUNABLE WHITE 2700-6500 K	Colour Temp.	· 3000 K · 4000 K <u>On request:</u> · TUNABLE WHITE 2700-6500 K

Ottiche Diffusers

DLM

Ottica darklight in alluminio speculare ad emissione "batwing". Valori di luminanza <math><1000\text{ cd/m}^2</math> per angoli >math>65^\circ</math>. Film interno in policarbonato opale anabbagliante per una maggiore uniformità luminosa. Conforme ad essere installata in ambienti con uso di videotermini secondo la norma UNI EN 12464-1.

Darklight specular aluminium diffuser with "batwing" emission. Luminance values <math><1000\text{ cd/m}^2</math> for angles >math>65^\circ</math>. Internal anti-glare opal polycarbonate film for a better light uniformity. Suitable for installation in workplaces with the use of video terminals according to EN 12464-1 standard.

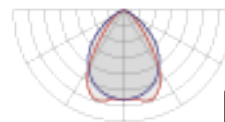

UGR
<math><19</math>

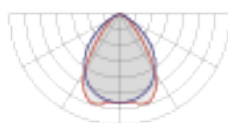
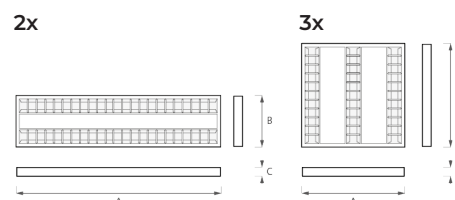

DLM



	Potenza Power [W]	Temp. colore Colour Temp. [K]	IRC CRI	Flusso lum. Lum. flux [lm]	Efficienza lum. Lum. effic. [lm / W]	Dimensioni/Dimensions [mm]			Cod. / Code LED	Cod. / Code LED DALI
						A	B	C		
2x	30	3000	>80	3420	114	1220	320	52	355100102	355100103
2x	30	4000	>80	3690	123	1220	320	52	355100104	355100105
2x	41	3000	>80	4674	114	1220	320	52	355100106	355100107
2x	41	4000	>80	5043	123	1220	320	52	355100108	355100109
2x	52	3000	>80	5928	114	1220	320	52	355100110	355100111
2x	52	4000	>80	6396	123	1220	320	52	355100112	355100113
3x	31	3000	>80	3534	114	620	620	52	355100090	355100091
3x	31	4000	>80	3813	123	620	620	52	355100092	355100093
3x	39	3000	>80	4446	114	620	620	52	355100094	355100095
3x	39	4000	>80	4797	123	620	620	52	355100096	355100097
3x	54	3000	>80	6156	114	620	620	52	355100098	355100099
3x	54	4000	>80	6642	123	620	620	52	355100100	355100101

1) Il flusso effettivo potrebbe avere una tolleranza del $\pm 10\%$. / The effective flux could have a tolerance of $\pm 10\%$.

Ledcube

IP40



Caratteristiche tecniche

Technical Characteristics

Corpo	Lamiera di acciaio	Body	Sheet-steel
Colore	<input type="radio"/> Bianco opaco (RAL 9010) <u>Su richiesta:</u> <input checked="" type="radio"/> Altri colori	Colour	<input type="radio"/> Matt white (RAL 9010) <u>On request:</u> <input checked="" type="radio"/> Other colours available
Gruppo ottico	<ul style="list-style-type: none"> • MOS - PMMA opale 	Optical group	<ul style="list-style-type: none"> • MOS - opal PMMA
Cablaggio	<ul style="list-style-type: none"> • LED ON/OFF con driver integrato • LED DALI con driver integrato <u>Su richiesta:</u> <ul style="list-style-type: none"> • Circuito RGB DMX • Kit di EMERGENZA (autonomia 1/3 h) 	Wiring	<ul style="list-style-type: none"> • LED ON/OFF with integrated driver • LED DALI with integrated driver <u>On request:</u> <ul style="list-style-type: none"> • DMX RGB circuit • EMERGENCY kit (1/3 h autonomy)
Grado di protezione	<ul style="list-style-type: none"> • IP 40 	Protection degree	<ul style="list-style-type: none"> • IP 40

Sorgenti LED

LED sources

IRC	<ul style="list-style-type: none"> • >90 	CRI	<ul style="list-style-type: none"> • >90
Temp. colore	<ul style="list-style-type: none"> • 3000 K • 4000 K <u>Su richiesta:</u> <ul style="list-style-type: none"> • TUNABLE WHITE 2700-6500 K • LED RGB 	Colour Temp.	<ul style="list-style-type: none"> • 3000 K • 4000 K <u>On request:</u> <ul style="list-style-type: none"> • TUNABLE WHITE 2700-6500 K • RGB LED

Ottiche

Diffusers

MOS

Diffusore in metacrilato PMMA, di forma parallelepipedica, con finitura opaca.
 Glow-wire test a 650°C secondo le norme CEI EN 60695-2-11.
 Methacrylate diffuser, parallelepiped shape, with matt finishing.
 Glow-wire test 650°C according to the CEI EN 60695-2-11 directives.

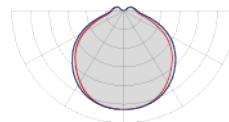

Accessori (da ordinare separatamente)
Accessories (to be ordered separately)

Sospensione / Suspension



L= 2000 mm
 Ø 0,75 mmq

**KIT SOSPENSIONE
 SUSPENSION KIT**

Cod. / Code KS20626x
 Rosone quadrato elettrificato (100x100mmx 25mm) di colore bianco opaco (RAL 9010) con morsettiera; cavi di sospensione metallici ad archetto (pz. 4 / kit) e cavo elettrificato trasparente.

Electrified square ceiling rose (100x100mmx 25mm) matt white coloured (RAL 9010) with connection terminal block; suspension cables (pcs. 4 / kit) and transparent power cable.

- **3** - cavo di alimentazione a 3 poli (ON/OFF) / 3 poles feeding cable (ON/OFF)
- **5** - cavo di alimentazione a 5 poli (DALI e ON/OFF + emergenza) / 5 poles feeding cable (DALI and ON/OFF + emergency)

**CAVO DI SOSPENSIONE
 SUSPENSION CABLE**

Cod. / Code KS001

È necessario ordinare 4 pz per ogni lampada
It is necessary to order 4 pcs. for each lamp



L= 2000 mm



L= 2000 mm
 Ø 0,75 mmq

**CAVO DI ALIMENTAZIONE TRASPARENTE
 TRANSPARENT ELECTRIFIED FEEDING CABLE**

Cod. / Code CVTxx075L020

- **3** poli (ON/OFF) / poles (ON/OFF)
- **5** poli (DALI e ON/OFF + emergenza) / poles (DALI and ON/OFF + emergency)
- **7** poli (DALI + emergenza) / poles (DALI + emergency)



**ROSONE QUADRATO ELETTRIFICATO
 ELECTRIFIED SQUARE CEILING ROSE**

Cod. / Code KS02526E

Lamiera di acciaio verniciato di colore bianco opaco (RAL 9010), 2 fori per il passaggio del cavo di alimentazione e di sospensione con morsettiera di connessione.

Powder coated in matt white (RAL 9010) colour sheet-steel, 2 holes for the passage of transparent power cable and suspension cable, with terminal block.

MOS

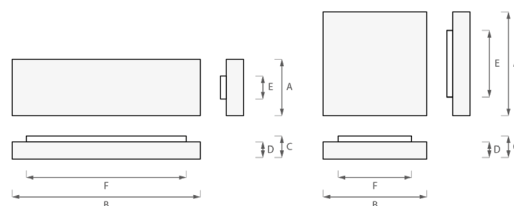
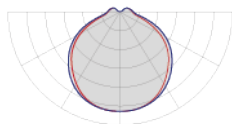

Potenza Power [W]	Temp. colore Colour Temp. [K]	IRC CRI	Flusso lum. Lum. flux [lm]	Efficienza lum. Lum. effic. [lm / W]	Dimensioni/Dimensions [mm]						Cod. / Code LED	Cod. / Code LED DALI
					A	B	C	D	E	F		
50	3000	>90	5300	106	350	1170	134	100	133	995	355200009	355200010
50	4000	>90	5750	115	350	1170	134	100	133	995	355200013	355200014
50	3000	>90	5300	106	600	600	134	100	385	425	355200001	355200002
50	4000	>90	5750	115	600	600	134	100	385	425	355200005	355200006
128	3000	>90	13568	106	1170	1170	134	100	953	995	355200017	355200018
128	4000	>90	14720	115	1170	1170	134	100	953	995	355200021	355200022
200	3000	>90	21200	106	1170	1170	134	100	953	995	355200025	355200026
200	4000	>90	23000	115	1170	1170	134	100	953	995	355200029	355200030

1) Il flusso effettivo potrebbe avere una tolleranza del ±10%. / The effective flux could have a tolerance of ±10%.

Block

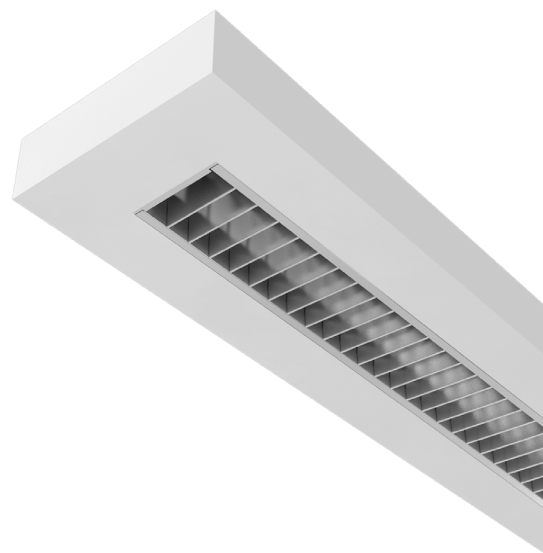
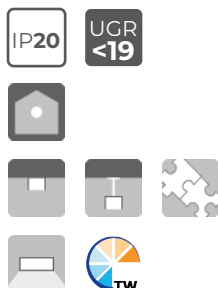

Caratteristiche tecniche

Technical Characteristics

Corpo	Lamiera di acciaio	Body	Sheet-steel
Colore	<ul style="list-style-type: none"> ○ Bianco Dry <u>Su richiesta:</u> ● Altri colori 	Colour	<ul style="list-style-type: none"> ○ Dry white <u>On request:</u> ● Other colours available
Gruppo ottico	<ul style="list-style-type: none"> · DLM - darklight (UGR<19) · PMO - policarbonato micropismatico (UGR<19) · PST - policarbonato opale satinato 	Optical group	<ul style="list-style-type: none"> · DLM - darklight (UGR<19) · PMO - microprismatic polycarbonate (UGR<19) · PST - glazed opal polycarbonate
Cablaggio	<ul style="list-style-type: none"> · LED ON/OFF con driver integrato · LED DALI con driver integrato <u>Su richiesta:</u> · Kit di EMERGENZA (autonomia 1/3 h) 	Wiring	<ul style="list-style-type: none"> · LED ON/OFF with integrated driver · LED DALI with integrated driver <u>On request:</u> · EMERGENCY kit (1/3 h autonomy)
Grado di protezione	<ul style="list-style-type: none"> · IP 20 	Protection degree	<ul style="list-style-type: none"> · IP 20

Sorgenti LED

LED sources

IRC	<ul style="list-style-type: none"> · >80 <u>Su richiesta:</u> · >90 	CRI	<ul style="list-style-type: none"> · >80 <u>On request:</u> · >90
Temp. colore	<ul style="list-style-type: none"> · 3000 K · 4000 K <u>Su richiesta:</u> · TUNABLE WHITE 2700-6500 K 	Colour Temp.	<ul style="list-style-type: none"> · 3000 K · 4000 K <u>On request:</u> · TUNABLE WHITE 2700-6500 K

Moduli ciechi / Infill module

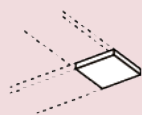

Giunto a 2 vie
2-way joint

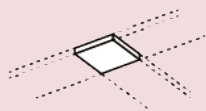

Giunto a 3 vie
3-way joint

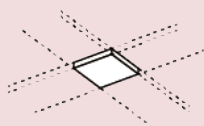

Giunto a 4 vie
4-way joint

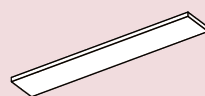

Modulo cieco lineare
Linear infill module

Ottiche Diffusers

PMO

Diffusore in policarbonato microprismatico anabbagliante. Valori di luminanza < 3000 cd/m² per angoli > 65°. Film interno in policarbonato opale anabbagliante per una maggiore uniformità luminosa. Conforme ad essere installata in ambienti con uso di videotermini secondo la norma UNI EN 12464-1.

Diffuser made of anti-glare microprismatic polycarbonate. Luminance values <3000 cd/m² for angles >65°. Internal anti-glare opal polycarbonate film for a better light uniformity. Suitable for installation in workplaces with the use of video terminals according to EN 12464-1 standard.

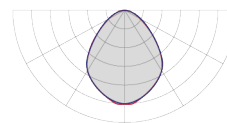

UGR
<19

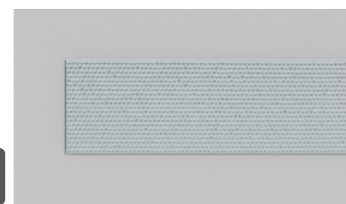

DLM

Ottica darklight in alluminio speculare ad emissione "batwing". Valori di luminanza <1000 cd/m² per angoli >65°. Film interno in policarbonato opale anabbagliante per una maggiore uniformità luminosa. Conforme ad essere installata in ambienti con uso di videotermini secondo la norma UNI EN 12464-1.

Darklight specular aluminium diffuser with "batwing" emission. Luminance values <1000 cd/m² for angles >65°. Internal anti-glare opal polycarbonate film for a better light uniformity. Suitable for installation in workplaces with the use of video terminals according to EN 12464-1 standard.

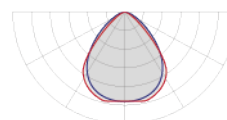

UGR
<19

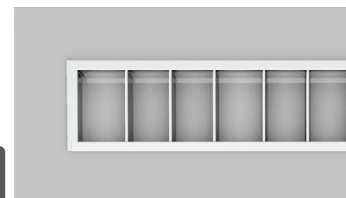

PST

Diffusore in policarbonato opale satinato a finitura liscia, ideale per una distribuzione uniforme.

Diffuser in glazed opal polycarbonate with smooth finish, ideal for uniform distribution.

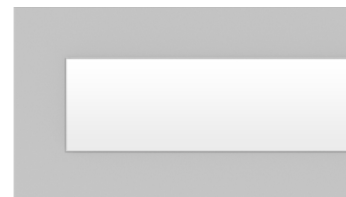
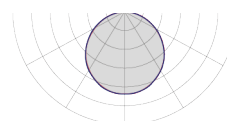

Accessori (da ordinare separatamente)
Accessories (to be ordered separately)

Giunti / Joints



STAFFA D'UNIONE UNION BRACKET

Cod. / Code KFS352100

Per l'installazione in linea continua, in acciaio zincato. Completo di viti di fissaggio.

Galvanized steel union bracket for continuous line installation. Fixing screws included.



MODULO CIECO ANGOLARE ANGULAR INFILL MODULE

Cod. / Code IN35210X

Lamiera di acciaio verniciata di colore bianco dry. Staffe di unione incluse.

Dry white powder coated sheet-steel. Union brackets included.

- **4L** : giunto a 2 vie / 2-way joint
- **4T** : giunto a 3 vie / 3-way joint
- **4** : giunto a 4 vie / 4-way joint



MODULO CIECO LINEARE LINEAR INFILL MODULE

Cod. / Code MC3521041X

Lamiera di acciaio verniciata di colore bianco dry. Staffe di unione incluse.

Dry white powder coated sheet-steel. Union brackets included.

- **300** : L = 1300 mm
- **600** : L = 1600 mm

Sospensione / Suspension



L = 1700 mm
Ø 0,75 mmq

KIT SOSPENSIONE SUSPENSION KIT

Cod. / Code KS10004X

Rosone quadrato elettrificato (100x100mmx 25mm) di colore bianco dry con morsettiera; cavi di sospensione metallici ad archetto (pz.2/kit) e cavo elettrificato trasparente (100x100mmx 25mm) dry white coloured with connection terminal block; suspension cables (pcs.2/kit) and transparent power cable

- **3** - cavo di alimentazione a 3 poli (ON/OFF) / 3 poles feeding cable (ON/OFF)
- **5** - cavo di alimentazione a 5 poli (DALI e ON/OFF + emergenza) / 5 poles feeding cable (DALI and ON/OFF + emergency)



L = 2000 mm
Ø 0,75 mmq

CAVO DI ALIMENTAZIONE TRASPARENTE TRANSPARENT ELECTRIFIED FEEDING CABLE

Cod. / Code CVTXX075L020

- **3** poli (ON/OFF) / poles (ON/OFF)
- **5** poli (DALI e ON/OFF + emergenza) / poles (DALI and ON/OFF + emergency)
- **7** poli (DALI + emergenza) / poles (DALI + emergency)



L = 2000 mm

CAVO DI SOSPENSIONE SUSPENSION CABLE

Cod. / Code KS009

È necessario ordinare 2 pz per ogni lampada. It is necessary to order 2 pcs. for each lamp.



ROSONE QUADRATO ELETTRIFICATO ELECTRIFIED SQUARE CEILING ROSE

Cod. / Code KS02504E

Lamiera di acciaio verniciata di colore bianco dry, 2 fori per il passaggio del cavo di alimentazione e di sospensione con morsettiera di connessione. Powder coated in white dry colour sheet-steel, 2 holes for the passage of transparent power cable and suspension cable, with terminal block.

PMO

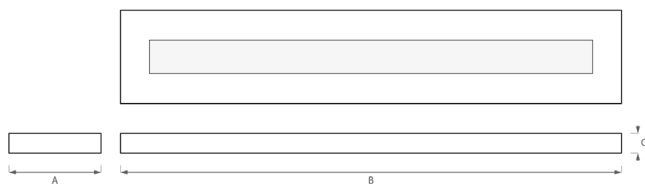
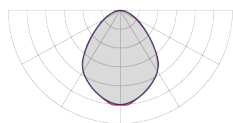

Potenza Power [W]	Temp. colore Colour Temp. [K]	IRC CRI	Flusso lum. Lum. flux [lm]	Efficienza lum. Lum. effic. [lm / W]	Dimensioni/Dimensions [mm]			Cod. / Code LED	Cod. / Code LED DALI
					A	B	C		
26	3000	>80	2496	96	240	1300	52	352100263	352100262
26	4000	>80	2678	103	240	1300	52	352100250	352100261
48	3000	>80	4608	96	240	1300	52	352100264	352100265
48	4000	>80	4944	103	240	1300	52	352100183	352100266
33	3000	>80	3168	96	240	1600	52	352100267	352100268
33	4000	>80	3399	103	240	1600	52	352100205	352100269
60	3000	>80	5760	96	240	1600	52	352100270	352100271
60	4000	>80	6180	103	240	1600	52	352100249	352100272

DLM

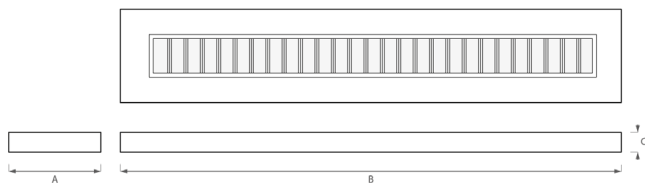
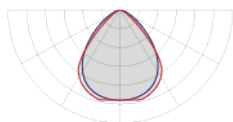

Potenza Power [W]	Temp. colore Colour Temp. [K]	IRC CRI	Flusso lum. Lum. flux [lm]	Efficienza lum. Lum. effic. [lm / W]	Dimensioni/Dimensions [mm]			Cod. / Code LED	Cod. / Code LED DALI
					A	B	C		
26	3000	>80	2600	100	240	1300	52	352100208	352100210
26	4000	>80	2782	107	240	1300	52	352100209	352100211
48	3000	>80	4800	100	240	1300	52	352100223	352100224
48	4000	>80	5136	107	240	1300	52	352100179	352100225
33	3000	>80	3300	100	240	1600	52	352100216	352100217
33	4000	>80	3531	107	240	1600	52	352100204	352100218
60	3000	>80	6000	100	240	1600	52	352100230	352100231
60	4000	>80	6420	107	240	1600	52	352100180	352100181

PST

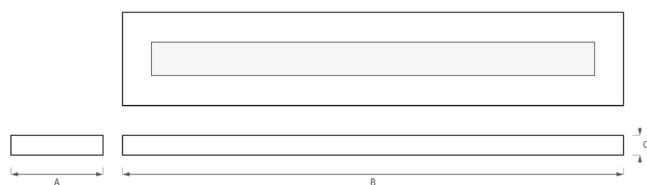
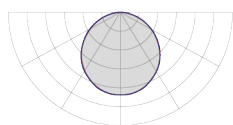

Potenza Power [W]	Temp. colore Colour Temp. [K]	IRC CRI	Flusso lum. Lum. flux [lm]	Efficienza lum. Lum. eff. [lm / W]	Dimensioni/Dimensions [mm]			Cod. / Code LED	Cod. / Code LED DALI
					A	B	C		
26	3000	>80	2002	77	240	1300	52	352100274	352100279
26	4000	>80	2158	83	240	1300	52	352100251	352100278
48	3000	>80	3696	77	240	1300	52	352100275	352100281
48	4000	>80	3984	83	240	1300	52	352100199	352100280
33	3000	>80	2541	77	240	1600	52	352100276	352100283
33	4000	>80	2739	83	240	1600	52	352100206	352100282
60	3000	>80	4620	77	240	1600	52	352100277	352100285
60	4000	>80	4980	83	240	1600	52	352100200	352100284



1) Il flusso effettivo potrebbe avere una tolleranza del ±10%. / The effective flux could have a tolerance of ±10%.

Plexi

IP50 UGR <19

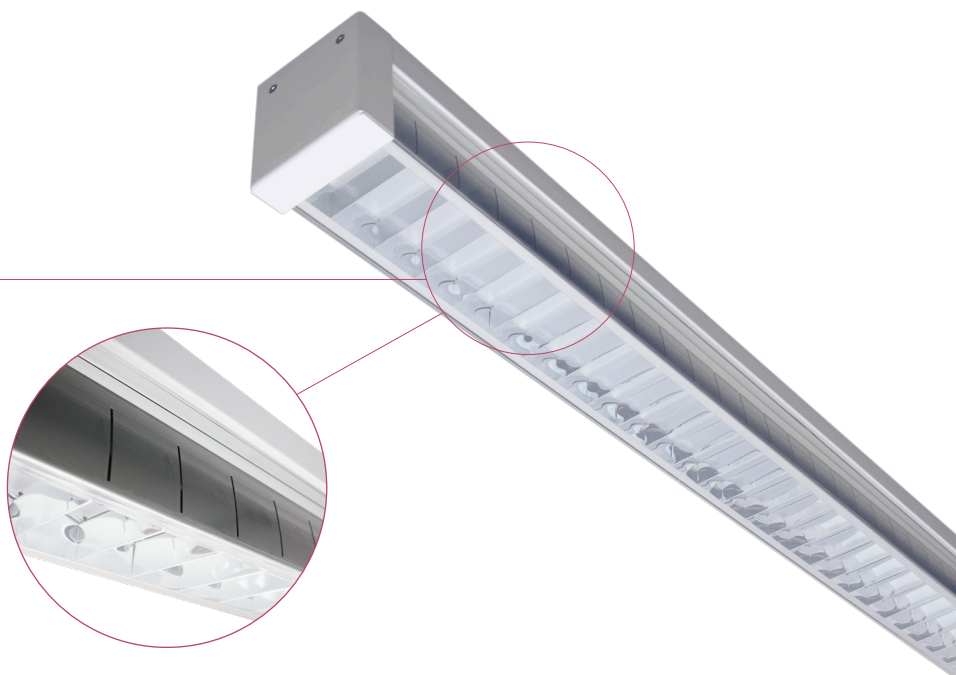

Caratteristiche tecniche

Technical Characteristics

Corpo	<ul style="list-style-type: none"> Corpo in lamiera di acciaio Diffusore esterno in PMMA trasparente antiurto 	Body	<ul style="list-style-type: none"> Sheet-steel body Shockproof PMMA transparent external diffuser
Colore	<ul style="list-style-type: none"> ○ Bianco opaco (RAL 9003) <p><u>Su richiesta:</u></p> <ul style="list-style-type: none"> ● Altri colori 	Colour	<ul style="list-style-type: none"> ○ Matt white (RAL 9003) <p><u>On request:</u></p> <ul style="list-style-type: none"> ● Other colours available
Gruppo ottico	<ul style="list-style-type: none"> DLM - MTR metacrilato antiurto trasparente 	Optical group	<ul style="list-style-type: none"> DLM- MTR transparent shockproof methacrylate
Cablaggio	<ul style="list-style-type: none"> LED ON/OFF con driver integrato LED DALI con driver integrato <p><u>Su richiesta:</u></p> <ul style="list-style-type: none"> Kit di EMERGENZA (autonomia 1/3 h) 	Wiring	<ul style="list-style-type: none"> LED ON/OFF with integrated driver LED DALI with integrated driver <p><u>On request:</u></p> <ul style="list-style-type: none"> EMERGENCY kit (1/3 h autonomy)
Grado di protezione	<ul style="list-style-type: none"> IP 50 	Protection degree	<ul style="list-style-type: none"> IP 50

Sorgenti LED

LED sources

IRC	<ul style="list-style-type: none"> >80 <p><u>Su richiesta:</u></p> <ul style="list-style-type: none"> >90 	CRI	<ul style="list-style-type: none"> >80 <p><u>On request:</u></p> <ul style="list-style-type: none"> >90
Temp. colore	<ul style="list-style-type: none"> 3000 K 4000 K <p><u>Su richiesta:</u></p> <ul style="list-style-type: none"> TUNABLE WHITE 2700-6500 K 	Colour Temp.	<ul style="list-style-type: none"> 3000 K 4000 K <p><u>On request:</u></p> <ul style="list-style-type: none"> TUNABLE WHITE 2700-6500 K

Ottiche

Diffusers

DLM

Ottica darklight in alluminio speculare ad emissione "batwing". Valori di luminanza <math><1000\text{ cd/m}^2</math> per angoli >math>65^\circ</math>. Film interno in policarbonato opale anabbagliante per una maggiore uniformità luminosa. Conforme ad essere installata in ambienti con uso di videoterminali secondo la norma UNI EN 12464-1.

Darklight specular aluminium diffuser with "batwing" emission. Luminance values <math><1000\text{ cd/m}^2</math> for angles >math>65^\circ</math>. Internal anti-glare opal polycarbonate film for a better light uniformity. Suitable for installation in workplaces with the use of video terminals according to EN 12464-1 standard.

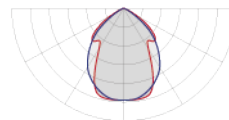

UGR <19

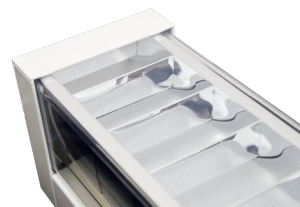

Accessori (da ordinare separatamente)
Accessories (to be ordered separately)

Sospensione / Suspension



L= 2000 mm
 Ø 0,75 mmq

**KIT SOSPENSIONE
 SUSPENSION KIT**

Cod. / Code KS20497X

Rosone quadrato elettrificato (100x100mmx 25mm) di colore bianco opaco (RAL 9003) con morsettiera; cavi di sospensione metallici ad archetto (pz.2/kit) e cavo elettrificato trasparente
 Electrified square ceiling rose (100x100mmx 25mm) matt white coloured (RAL 9003) with connection terminal block; suspension cables (pcs.2/kit) and transparent power cable

- **3** - cavo di alimentazione a 3 poli (ON/OFF)/ 3 poles feeding cable (ON/OFF)
- **5** - cavo di alimentazione a 5 poli (DALI e ON/OFF + emergenza) / 5 poles feeding cable (DALI and ON/OFF + emergency)

**CAVO DI SOSPENSIONE
 SUSPENSION CABLE**

Cod. / Code KS013

È necessario ordinare 2 pz per ogni lampada
 It is necessary to order 2 pcs. for each lamp



L= 2000 mm



L= 2000 mm
 Ø 0,75 mmq

**CAVO DI ALIMENTAZIONE TRASPARENTE
 TRANSPARENT ELECTRIFIED FEEDING
 CABLE**

Cod. / Code CVTX075L020

- **3** poli (ON/OFF)/poles (ON/OFF)
- **5** poli (DALI e ON/OFF + emergenza)/ poles (DALI and ON/OFF + emergency)
- **7** poli (DALI + emergenza)/ poles (DALI + emergency)



**ROSONE QUADRATO ELETTRIFICATO
 ELECTRIFIED SQUARE CEILING ROSE**

Cod. / Code KS02597E

Lamiera di acciaio verniciato di colore bianco opaco (RAL 9003), 2 fori per il passaggio del cavo di alimentazione e di sospensione con morsettiera di connessione
 Powder coated in matt white colour sheet-steel (RAL 9003), 2 holes for the passage of transparent power cable and suspension cable, with terminal block

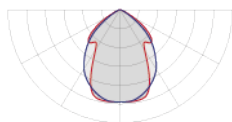
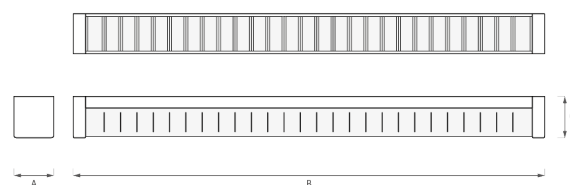

DLM



Potenza Power [W]	Temp. colore Colour Temp. [K]	IRC CRI	Flusso lum. Lum. flux [lm]	Efficienza lum. Lum. effic. [lm / W]	Dimensioni/Dimensions [mm]			Cod. / Code LED	Cod. / Code LED DALI
					A	B	C		
26	3000	>80	2366	91	100	1182	103	331300001	331300005
26	4000	>80	2548	98	100	1182	103	331300009	331300013
33	3000	>80	3003	91	100	1482	103	331300002	331300006
33	4000	>80	3234	98	100	1482	103	331300010	331300014
48	3000	>80	4368	91	100	1182	103	331300003	331300007
48	4000	>80	4704	98	100	1182	103	331300011	331300015
60	3000	>80	5460	91	100	1482	103	331300004	331300008
60	4000	>80	5880	98	100	1482	103	331300012	331300016

1) Il flusso effettivo potrebbe avere una tolleranza del ±10%. / The effective flux could have a tolerance of ±10%.

Way 2-Line

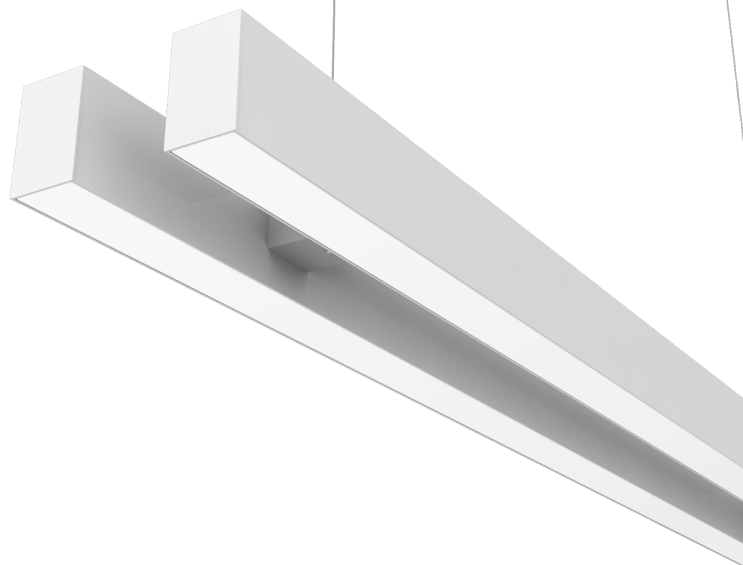

Caratteristiche tecniche

Technical Characteristics

Corpo	Profilo estruso in alluminio (6060)	Body	Extruded aluminium profile (6060)
Colore	<input type="radio"/> Bianco Dry <u>Su richiesta:</u> <input checked="" type="radio"/> Altri colori	Colour	<input type="radio"/> Dry white <u>On request:</u> <input checked="" type="radio"/> Other colours available
Gruppo ottico	<ul style="list-style-type: none"> PMO - policarbonato microprismatico (UGR<19) PST - policarbonato opale satinato 	Optical group	<ul style="list-style-type: none"> PMO - microprismatic polycarbonate (UGR<19) PST - glazed opal polycarbonate
Cablaggio	<ul style="list-style-type: none"> LED ON/OFF con driver integrato LED DALI con driver integrato <u>Su richiesta:</u> <ul style="list-style-type: none"> Kit di EMERGENZA (autonomia 1/3 h) 	Wiring	<ul style="list-style-type: none"> LED ON/OFF with integrated driver LED DALI with integrated driver <u>On request:</u> <ul style="list-style-type: none"> EMERGENCY kit (1/3 h autonomy)
Grado di protezione	<ul style="list-style-type: none"> IP 40 	Protection degree	<ul style="list-style-type: none"> IP 40

Sorgenti LED

LED sources

IRC	<ul style="list-style-type: none"> >80 <u>Su richiesta:</u> <ul style="list-style-type: none"> >90 	CRI	<ul style="list-style-type: none"> >80 <u>On request:</u> <ul style="list-style-type: none"> >90
Temp. colore	<ul style="list-style-type: none"> 3000 K 4000 K <u>Su richiesta:</u> <ul style="list-style-type: none"> TUNABLE WHITE 2700-6500 K 	Colour Temp.	<ul style="list-style-type: none"> 3000 K 4000 K <u>On request:</u> <ul style="list-style-type: none"> TUNABLE WHITE 2700-6500 K

Ottiche Diffusers

PMO

Diffusore in policarbonato microprismatico anabbagliante. Valori di luminanza < 3000 cd/m² per angoli > 65°. Film interno in policarbonato opale anabbagliante per una maggiore uniformità luminosa. Conforme ad essere installata in ambienti con uso di videotermini secondo la norma UNI EN 12464-1.

Diffuser made of anti-glare microprismatic polycarbonate. Luminance values <3000 cd/m² for angles >65°. Internal anti-glare opal polycarbonate film for a better light uniformity. Suitable for installation in workplaces with the use of video terminals according to EN 12464-1 standard.

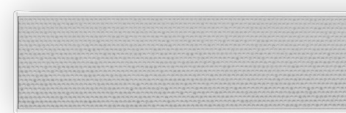
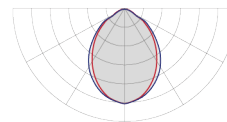

UGR
<19

PST

Diffusore in policarbonato opale satinato a finitura liscia, ideale per una distribuzione uniforme.

Diffuser in glazed opal polycarbonate with smooth finish, ideal for uniform distribution.

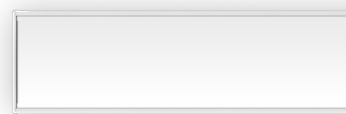
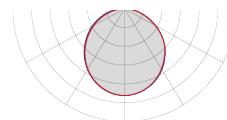

Accessori (da ordinare separatamente) Accessories (to be ordered separately)

Sospensione / Suspension



L= 2000 mm
Ø 0,75 mmq

KIT SOSPENSIONE SUSPENSION KIT

Cod. / Code **KS20304X**

Rosone quadrato elettrificato (100x100mmx 25mm) di colore bianco dry con morsettiera; cavi di sospensione metallici (pz.2/kit) e cavo elettrificato trasparente

Electrified square ceiling rose (100x100mmx 25mm) dry white coloured with connection terminal block; suspension cables (pcs.2/kit) and transparent power cable

- **3** - cavo di alimentazione a 3 poli (ON/OFF)/ 3 poles feeding cable (ON/OFF)
- **5** - cavo di alimentazione a 5 poli (DALI e ON/OFF + emergenza) / 5 poles feeding cable (DALI and ON/OFF + emergency)



L= 2000 mm

CAVO DI SOSPENSIONE SUSPENSION CABLE

Cod. / Code **KS012**

È necessario ordinare 2 pz per ogni lampada
It is necessary to order 2 pcs. for each lamp



L= 2000 mm
Ø 0,75 mmq

CAVO DI ALIMENTAZIONE TRASPARENTE TRANSPARENT ELECTRIFIED FEEDING CABLE

Cod. / Code **CVTXX075L020**

- **3** poli (ON/OFF)/poles (ON/OFF)
- **5** poli (DALI e ON/OFF + emergenza)/ poles (DALI and ON/OFF + emergency)
- **7** poli (DALI + emergenza)/ poles (DALI + emergency)



ROSONE QUADRATO ELETTRIFICATO ELECTRIFIED SQUARE CEILING ROSE

Cod. / Code **KS02504E**

Lamiera di acciaio verniciato di colore bianco dry, 2 fori per il passaggio del cavo di alimentazione e di sospensione con morsettiera di connessione.
Powder coated in white dry colour sheet-steel, 2 holes for the passage of transparent power cable and suspension cable, with terminal block.

PMO

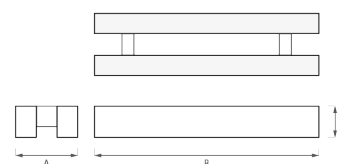
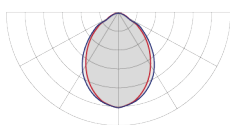

Potenza Power [W]	Temp. colore Colour Temp. [K]	IRC CRI	Flusso lum. Lum. flux [lm]	Efficienza lum. Lum. effic. [lm / W]	Dimensioni/Dimensions [mm]			Cod. / Code LED	Cod. / Code LED DALI
					A	B	C		
26	3000	>80	2184	84	170	565	78	662000233	662000243
26	4000	>80	2340	90	170	565	78	662000234	662000244
40	3000	>80	3360	84	170	845	78	662000289	662000290
40	4000	>80	3600	90	170	845	78	662000299	662000300
52	3000	>80	4368	84	170	1125	78	662000291	662000292
52	4000	>80	4680	90	170	1125	78	662000301	662000302
78	3000	>80	6552	84	170	1685	78	662000293	662000294
78	4000	>80	7020	90	170	1685	78	662000303	662000304
104	3000	>80	8736	84	170	2245	78	662000295	662000296
104	4000	>80	9360	90	170	2245	78	662000305	662000306
130	3000	>80	10920	84	170	2805	78	662000297	662000298
130	4000	>80	11700	90	170	2805	78	662000307	662000308

PST

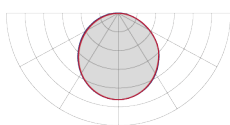

Potenza Power [W]	Temp. colore Colour Temp. [K]	IRC CRI	Flusso lum. Lum. flux [lm]	Efficienza lum. Lum. effic. [lm / W]	Dimensioni/Dimensions [mm]			Cod. / Code LED	Cod. / Code LED DALI
					A	B	C		
26	3000	>80	2210	85	170	565	78	662000197	662000215
26	4000	>80	2366	91	170	565	78	662000198	662000216
40	3000	>80	3400	85	170	845	78	662000269	662000270
40	4000	>80	3640	91	170	845	78	662000271	662000272
52	3000	>80	4420	85	170	1125	78	662000273	662000274
52	4000	>80	4732	91	170	1125	78	662000275	662000276
78	3000	>80	6630	85	170	1685	78	662000277	662000279
78	4000	>80	7098	91	170	1685	78	662000278	662000280
104	3000	>80	8840	85	170	2245	78	662000281	662000282
104	4000	>80	9464	91	170	2245	78	662000283	662000284
130	3000	>80	11050	85	170	2805	78	662000285	662000286
130	4000	>80	11830	91	170	2805	78	662000287	662000288

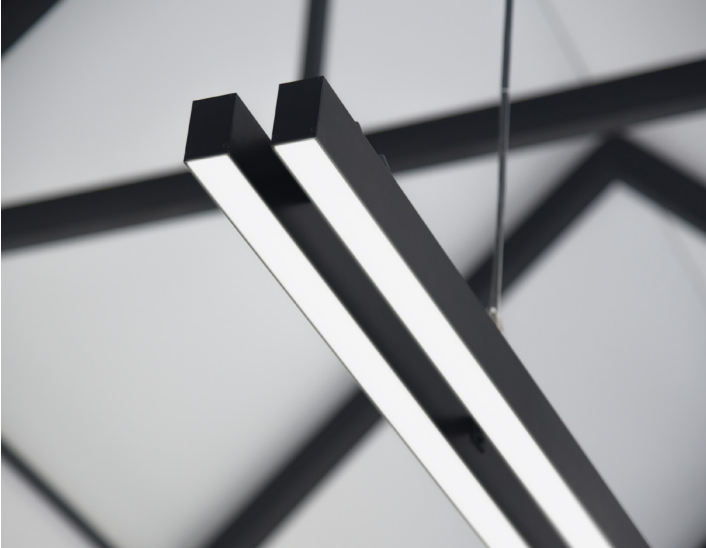

AT/Prisma



1x



2x



Caratteristiche tecniche

Technical Characteristics

Corpo · Base di cablaggio in lamiera di acciaio
· Corpo in policarbonato

Colore ○ Bianco (RAL9003)

Gruppo ottico · CPT - policarbonato traslucido

Cablaggio · LED ON/OFF con driver integrato
· LED DALI con driver integrato

Su richiesta:

· LED + SN con driver e sensore di presenza integrati, solo per la versione AT/PRISMA 2X
· Kit di EMERGENZA (autonomia 1/3 h)

Grado di protezione · IP 54
Su richiesta:
· IK 10

Body · Sheet steel wiring plate
· Polycarbonate body

Colour ○ White (RAL9003)

Optical group · CPT - translucent polycarbonate

Wiring · LED ON/OFF with integrated driver
· LED DALI with integrated driver

On request:

· LED + SN with integrated driver and motion sensor, only for AT/PRISMA 2X version
· EMERGENCY kit (1/3 h autonomy)

Protection degree · IP 54
On request:
· IK 10

Sorgenti LED

LED sources

IRC · >80

CRI · >80

Temp. colore · 3000 K
· 4000 K
Su richiesta:
· 5000 K
· 6500 K

Colour Temp. · 3000 K
· 4000 K
On request:
· 5000 K
· 6500 K

Ottiche Diffusers

CPT

Diffusore in policarbonato traslucido, stabilizzato ai raggi UV, ad altissima resistenza meccanica. Glow-wire test a 850°C secondo le norme CEI EN 60695-2-11.
 Translucent polycarbonate diffuser, UV stabilized with high mechanical resistance. Glow-wire test 850°C according to the CEI EN 60695-2-11 directives.

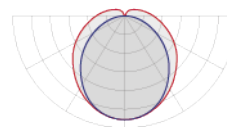

Accessori (da ordinare separatamente)

Accessories (to be ordered separately)



GABBIA PROTETTIVA PROTECTIVE GRID

Cod. / Code **GBP3420010002**

Protezione metallica di colore bianco.
White metal protection

• Dim. 220 x 1300 x 130mm



CPT

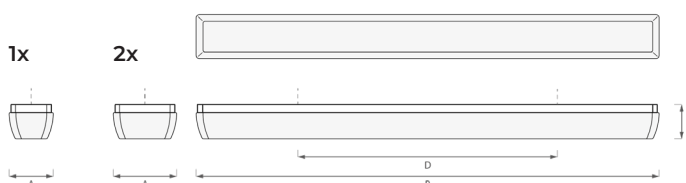
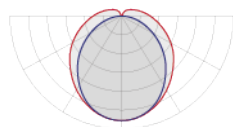

	Potenza Power [W]	Temp. colore Colour Temp. [K]	IRC CRI	Flusso lum. Lum. flux [lm]	Efficienza lum. Lum. effic. [lm / W]	Dimensioni / Dimensions [mm]				Cod. / Code LED	Cod. / Code LED DALI
						A	B	C	D		
1x	16	3000	>80	2062	128	109	1160	85	650	342000119	342000120
1x	16	4000	>80	2170	135	109	1160	85	650	342000131	342000132
1x	20	3000	>80	2480	124	109	1160	85	650	342000123	342000124
1x	20	4000	>80	2610	130	109	1160	85	650	342000135	342000136
1x	27	3000	>80	3468	128	109	1160	85	650	342000127	342000128
1x	27	4000	>80	3650	135	109	1160	85	650	342000139	342000140
2x	31	3000	>80	4009	129	159	1160	85	650	342000143	342000144
2x	31	4000	>80	4220	136	159	1160	85	650	342000155	342000156
2x	37	3000	>80	4874	131	159	1160	85	650	342000147	342000148
2x	37	4000	>80	5130	138	159	1160	85	650	342000159	342000160
2x	51	3000	>80	6783	133	159	1160	85	650	342000151	342000152
2x	51	4000	>80	7140	140	159	1160	85	650	342000163	342000164

Mirror

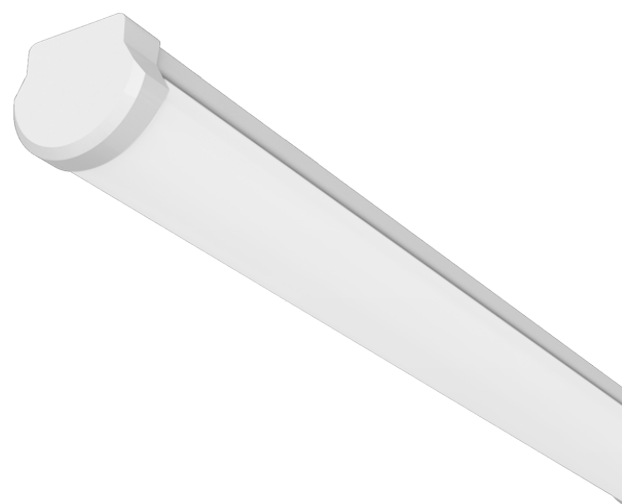

1x



2x

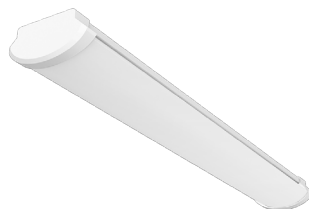

Caratteristiche tecniche

Technical Characteristics

Corpo	<ul style="list-style-type: none"> · Lamiera di acciaio · Testate di chiusura in ABS 	Body	<ul style="list-style-type: none"> · Sheet-steel · ABS end-caps
Colore	○ Bianco (RAL9003)	Colour	○ White (RAL9003)
Gruppo ottico	· CPT - policarbonato traslucido	Optical group	· CPT - translucent polycarbonate
Cablaggio	<ul style="list-style-type: none"> · LED ON/OFF con driver integrato · LED DALI con driver integrato <p><u>Su richiesta:</u></p> <ul style="list-style-type: none"> · LED + SN con driver e sensore di presenza integrati, solo per la versione MIRROR 2X · Kit di EMERGENZA (autonomia 1/3 h) 	Wiring	<ul style="list-style-type: none"> · LED ON/OFF with integrated driver · LED DALI with integrated driver <p><u>On request:</u></p> <ul style="list-style-type: none"> · LED + SN with integrated driver and motion sensor, only for MIRROR 2X version · EMERGENCY kit (1/3 h autonomy)
Grado di protezione	<ul style="list-style-type: none"> · IP 40 <p><u>Su richiesta:</u></p> <ul style="list-style-type: none"> · IK 10 	Protection degree	<ul style="list-style-type: none"> · IP 40 <p><u>On request:</u></p> <ul style="list-style-type: none"> · IK 10

Sorgenti LED

LED sources

IRC	<ul style="list-style-type: none"> · >80 <p><u>Su richiesta:</u></p> <ul style="list-style-type: none"> · >90 	CRI	<ul style="list-style-type: none"> · >80 <p><u>On request:</u></p> <ul style="list-style-type: none"> · >90
Temp. colore	<ul style="list-style-type: none"> · 3000 K · 4000 K <p><u>Su richiesta:</u></p> <ul style="list-style-type: none"> · 5000 K · 6500 K 	Colour Temp.	<ul style="list-style-type: none"> · 3000 K · 4000 K <p><u>On request:</u></p> <ul style="list-style-type: none"> · 5000 K · 6500 K

Ottiche Diffusers

CPT

Diffusore in policarbonato traslucido, stabilizzato ai raggi UV, ad altissima resistenza meccanica. Glow-wire test a 850°C secondo le norme CEI EN 60695-2-11.
 Translucent polycarbonate diffuser, UV stabilized with high mechanical resistance. Glow-wire test 850°C according to the CEI EN 60695-2-11 directives.

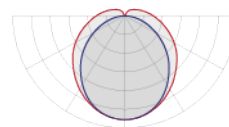

Accessori (da ordinare separatamente) Accessories (to be ordered separately)



GABBIA PROTETTIVA PROTECTIVE GRID

Cod. / Code **GBP359001000X**
 Protezione metallica di colore bianco.
 White metal protection

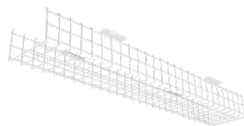

- **1** - Dim. 220 x 700 x 130mm
- **2** - Dim. 220 x 1300 x 130mm
- **3** - Dim. 220 x 1600 x 130mm

CPT

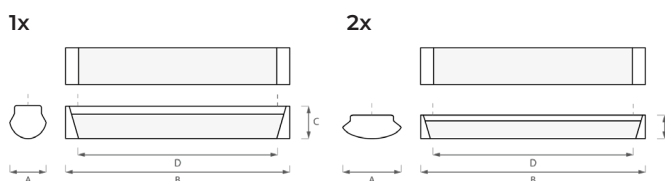
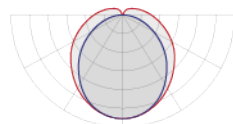

	Potenza Power [W]	Temp. colore Colour Temp. [K]	IRC CRI	Flusso lum. Lum. flux [lm]	Efficienza lum. Lum. effic. [lm / W]	Dimensioni / Dimensions [mm]				Cod. / Code LED	Cod. / Code LED DALI
						A	B	C	D		
1x	8	3000	>80	1017	127	91	610	82	500	359000175	359000176
1x	8	4000	>80	1070	133	91	610	82	500	359000177	359000178
1x	10	3000	>80	1216	121	91	610	82	500	359000132	359000133
1x	10	4000	>80	1280	128	91	610	82	500	359000052	359000093
1x	16	3000	>80	1986	124	91	1170	82	1000	359000179	359000180
1x	16	4000	>80	2090	130	91	1170	82	1000	359000183	359000184
1x	20	3000	>80	2394	119	91	1170	82	1000	359000181	359000182
1x	20	4000	>80	2520	126	91	1170	82	1000	359000185	359000186
1x	20	3000	>80	2489	124	91	1450	82	1000	359000187	359000188
1x	20	4000	>80	2620	131	91	1450	82	1000	359000191	359000192
1x	24	3000	>80	2983	124	91	1450	82	1000	359000189	359000190
1x	24	4000	>80	3140	130	91	1450	82	1000	359000193	359000194
2x	16	3000	>80	2024	126	146	610	58	500	359000195	359000196
2x	16	4000	>80	2130	133	146	610	58	500	359000199	359000200
2x	19	3000	>80	2394	126	146	610	58	500	359000197	359000198
2x	19	4000	>80	2520	132	146	610	58	500	359000201	359000202
2x	31	3000	>80	3962	127	146	1170	58	1000	359000203	359000204
2x	31	4000	>80	4170	134	146	1170	58	1000	359000211	359000212
2x	37	3000	>80	4817	130	146	1170	58	1000	359000207	359000208
2x	37	4000	>80	5070	137	146	1170	58	1000	359000215	359000216
2x	38	3000	>80	4912	129	146	1450	58	1000	359000219	359000220
2x	38	4000	>80	5170	136	146	1450	58	1000	359000229	359000230
2x	46	3000	>80	5966	129	146	1450	58	1000	359000223	359000224
2x	46	4000	>80	6280	136	146	1450	58	1000	359000233	359000234

1) Il flusso effettivo potrebbe avere una tolleranza del ±10%. / The effective flux could have a tolerance of ±10%.



Koled

IP66

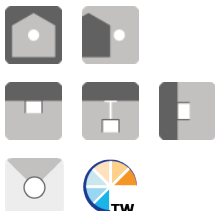

Caratteristiche tecniche

Technical Characteristics

Corpo	Tubo diffusore in policarbonato satinato Testate laterali in alluminio	Body	Glazed polycarbonate diffuser tube Aluminium end-caps
Colore	○ Bianco opaco (RAL 9003) <u>Su richiesta:</u> ● Altri colori	Colour	○ Matt white (RAL 9003) <u>On request:</u> ● Other colours available
Gruppo ottico	· POT - policarbonato opale	Optical group	· POT - opal polycarbonate
Cablaggio	· LED ON/OFF con driver integrato · LED DALI con driver integrato <u>Su richiesta:</u> · Kit di EMERGENZA (autonomia 1/3 h)	Wiring	· LED ON/OFF with integrated driver · LED DALI with integrated driver <u>On request:</u> · EMERGENCY kit (1/3 h autonomy)
Grado di protezione	· IP 66	Protection degree	· IP 66

Sorgenti LED

LED sources

IRC	· >80 <u>Su richiesta:</u> · >90	CRI	· >80 <u>On request:</u> · >90
Temp. colore	· 3000 K · 4000 K <u>Su richiesta:</u> · TUNABLE WHITE 2700-6500 K	Colour Temp.	· 3000 K · 4000 K <u>On request:</u> · TUNABLE WHITE 2700-6500 K

Ottiche

Diffusers

POT

Diffusore in policarbonato opale o a finitura liscia, ideale per una distribuzione uniforme.

Diffuser in opal polycarbonate with smooth finish, ideal for uniform distribution.

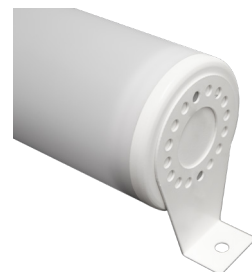
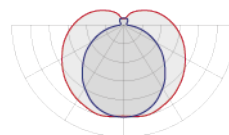

Accessori (da ordinare separatamente)
Accessories (to be ordered separately)

Sospensione / Suspension



L= 2000 mm

KIT DI SOSPENSIONE BIANCO
WHITE SUSPENSION KIT

Cod. / Code KS20597X

Rosone tondo elettrificato (Ø 100mm x H. 22mm) di colore bianco opaco (RAL 9003) con morsetteria; cavi di sospensione metallici (pz.2/kit) e cavo elettrificato trasparente
Electrified round ceiling rose (Ø100mm x H. 22mm) matt white powder coated (RAL 9003) with connection terminal block; suspension cables (pcs.2/kit) and transparent power cable

- **3** - cavo di alimentazione a 3 poli (ON/OFF) / 3 poles feeding cable (ON/OFF)
- **5** - cavo di alimentazione a 5 poli (DALI e ON/OFF + emergenza) / 5 poles feeding cable (DALI and ON/OFF + emergency)



Ø= 100 mm
H= 22 mm

ROSONE TONDO ELETTRIFICATO
ELECTRIFIED ROUND CEILING ROSE

Cod. / Code KS20097M

Lamiera d'acciaio verniciato di colore bianco opaco (RAL 9003), 1 foro per il passaggio del cavo di alimentazione con morsetteria di connessione
Matt white powder coated sheet-steel ceiling rose (RAL 9003) with connection terminal block



L= 2000 mm
Ø= 0,75 mmq

CAVO DI ALIMENTAZIONE TRASPARENTE
TRANSPARENT ELECTRIFIED FEEDING CABLE

Cod. / Code CVTXX075L020

- **3** poli (ON/OFF) / poles (ON/OFF)
- **5** poli (DALI e ON/OFF + emergenza) / poles (DALI and ON/OFF + emergency)
- **7** poli (DALI + emergenza) / poles (DALI + emergency)



L= 2000 mm

CAVO DI SOSPENSIONE
SUSPENSION CABLE

Cod. / Code KS001

È necessario ordinare 2 pz. per ogni lampada
It is necessary to order 2 pcs. for each lamp

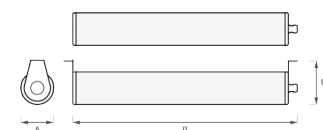
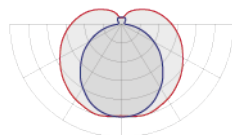

POT



Potenza Power [W]	Temp. colore Colour Temp. [K]	IRC CRI	Flusso lum. Lum. flux [lm]	Efficienza lum. Lum. effic. [lm / W]	Dimensioni/Dimensions [mm]			Cod. / Code LED	Cod. / Code LED DALI
					A	B	C		
13	3000	>80	1273	97	135	650	100	381800067	381800068
13	4000	>80	1373	105	135	650	100	381800069	381800070
26	3000	>80	2546	97	135	650	100	381800071	381800072
26	4000	>80	2746	105	135	650	100	381800073	381800074
26	3000	>80	2546	97	135	1210	100	381800075	381800076
26	4000	>80	2746	105	135	1210	100	381800057	381800077
52	3000	>80	5092	97	135	1210	100	381800078	381800079
52	4000	>80	5492	105	135	1210	100	381800058	381800080

1) Il flusso effettivo potrebbe avere una tolleranza del ±10%. / The effective flux could have a tolerance of ±10%.



Tukoon

IP54

IP65



Caratteristiche tecniche

Technical Characteristics

Corpo	<ul style="list-style-type: none"> • Estruso di alluminio completo di testate • Tubo in policarbonato trasparente 	Body	<ul style="list-style-type: none"> • Extruded aluminium profile with end-caps • Transparent polycarbonate tube
Colore	<ul style="list-style-type: none"> ○ Bianco opaco (RAL 9003) <p><u>Su richiesta:</u></p> <ul style="list-style-type: none"> ● Altri colori 	Colour	<ul style="list-style-type: none"> ○ Matt white (RAL 9003) <p><u>On request:</u></p> <ul style="list-style-type: none"> ● Other colours available
Gruppo ottico	<ul style="list-style-type: none"> • PTR - policarbonato trasparente 	Optical group	<ul style="list-style-type: none"> • PTR - transparent polycarbonate
Cablaggio	<ul style="list-style-type: none"> • ¹⁾ LED ON/OFF • ¹⁾ LED DALI <p><u>Su richiesta:</u></p> <ul style="list-style-type: none"> • ¹⁾ Circuito RGB 	Wiring	<ul style="list-style-type: none"> • ¹⁾ LED ON/OFF • ¹⁾ LED DALI <p><u>On request:</u></p> <ul style="list-style-type: none"> • ¹⁾ RGB circuit
Grado di protezione	<ul style="list-style-type: none"> IP 54 <p><u>Su richiesta:</u></p> <ul style="list-style-type: none"> • IP65 	Protection degree	<ul style="list-style-type: none"> IP 54 <p><u>On request:</u></p> <ul style="list-style-type: none"> • IP65

Sorgenti LED

LED sources

IRC	<ul style="list-style-type: none"> >90 <p><u>Su richiesta:</u></p> <ul style="list-style-type: none"> • >80 	CRI	<ul style="list-style-type: none"> >90 <p><u>On request:</u></p> <ul style="list-style-type: none"> • >80
Temp. colore	<ul style="list-style-type: none"> • 3000 K • 4000 K <p><u>Su richiesta:</u></p> <ul style="list-style-type: none"> • TUNABLE WHITE 2700-6500 K • LED RGB 	Colour Temp.	<ul style="list-style-type: none"> • 3000 K • 4000 K <p><u>On request:</u></p> <ul style="list-style-type: none"> • TUNABLE WHITE 2700-6500 K • RGB LED

Ottiche

Diffusers

PTR

Diffusore in policarbonato trasparente a finitura liscia.
Diffuser in transparent polycarbonate with smooth finish.

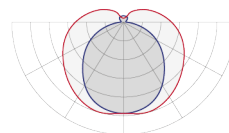

Accessori (da ordinare separatamente)
Accessories (to be ordered separately)

Sospensione / Suspension



2 pcs.kit
L= 2000 mm

**KIT DI SOSPENSIONE
 SUSPENSION KIT**
Cod. / Code KS720
 Cavi metallici di sospensione,
 relativa minuteria inclusa
*Metal cables,
 fixing parts included*



Ø= 100 mm
H= 22 mm

**ROSONE TONDO ELETTRIFICATO
 ELECTRIFIED ROUND CEILING ROSE**
Cod. / Code KS20097M

Lamiera d'acciaio verniciato di colore bianco opaco (RAL 9003), 1 foro per il passaggio del cavo di alimentazione con morsetteria di connessione
Matt white powder coated sheet-steel ceiling rose (RAL 9003) with connection terminal block

Alimentatori / Drivers

		Potenza Power [W]	Tensione in ingresso Lum. effic. [V ; Hz]	Dimensioni / Dimensions [mm]	Cod. / Code	
IP20	ON/OFF	20	220-240 ; 50	148 x 45,8 x 22,5	711000013	
		50	110-240 ; 50/60	172,2 x 63 x 30	711000015	
		75	110-240 ; 50/60	193,2 x 63 x 30	711000016	
		150	220-240 ; 50/60	180 x 65,5 x 31,2	711000042	
	DALI	35	220-240 ; 50/60 220-240 ; 0	195 x 43 x 30,2	711000044	
		60	220-240 ; 50/60 220-240 ; 0	225 x 43 x 30,2	711000045	
		100	220-240 ; 50/60 220-240 ; 0	295 x 43 x 29,8	711000046	
		150	220-240 ; 50/60 220-240 ; 0	325 x 43 x 29,8	711000047	
	DMX	55	220-240 ; 50/60	147 x 75 x 39	711000039	
		100	110-240 ; 50/60	207 x 76 x 35	711000011	
	IP67	ON/OFF	20	110-240 ; 50/60 220-240 ; 0	118 x 35 x 26	711000010
			60	110-240 ; 50/60 220-240 ; 0	162,5 x 42,5 x 32	711000018
100			110-240 ; 50/60 220-240 ; 0	190 x 52 x 37	711000019	
150			110-240 ; 50/60	191 x 63 x 37,5	711000020	

PTR

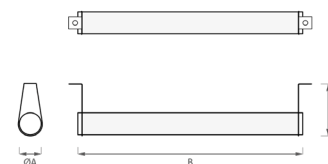
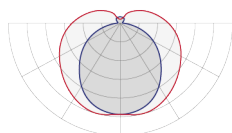

Potenza Power [W]	Temp. colore Colour Temp. [K]	IRC CRI	Flusso lum. Lum. flux [lm]	Efficienza lum. Lum. effic. [lm / W]	Dimensioni/Dimensions [mm]			Cod. / Code LED
					A	B	C	
9	3000	>90	521	58	28	600	66	720000012
9	4000	>90	563	63	28	600	66	720000013
18	3000	>90	1042	58	28	1160	66	720000014
18	4000	>90	1125	63	28	1160	66	720000015

1) Il flusso effettivo potrebbe avere una tolleranza del ±10%. / The effective flux could have a tolerance of ±10%.

Sticky

IP20



Caratteristiche tecniche

Technical Characteristics

Corpo	Estruso di alluminio completo di rosone tondo	Body	Extruded aluminium profile with round ceiling rose
Colore	<input type="radio"/> Bianco Dry <input checked="" type="radio"/> Nero Dry Su richiesta: <input checked="" type="radio"/> Altri colori	Colour	<input type="radio"/> Dry white <input checked="" type="radio"/> Dry black On request: <input checked="" type="radio"/> Other colours available
Gruppo ottico	· PMMA - Lente in PMMA (35°)	Optical group	· PMMA - PMMA Lens (35° beam angle)
Cablaggio	<ul style="list-style-type: none"> · LED ON/OFF con driver integrato · LED DALI con driver integrato 	Wiring	<ul style="list-style-type: none"> · LED ON/OFF with integrated driver · LED DALI with integrated driver
Grado di protezione	· IP 20	Protection degree	· IP 20

Sorgenti LED

LED sources

IRC	· >80	CRI	· >80
Temp. colore	<ul style="list-style-type: none"> · 3000 K · 4000 K 	Colour Temp.	<ul style="list-style-type: none"> · 3000 K · 4000 K

Ottiche Diffusers

PMMA

Lente in PMMA trasparente ad altissima efficienza >95%, stabilizzato ai raggi UV.
PMMA Lens highly efficient up to 95% transparent lens, UV rays stabilized.

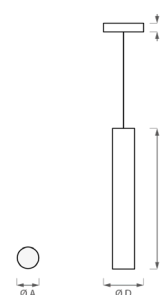
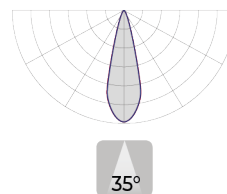

PMMA



Potenza Power [W]	Temp. colore Colour Temp. [K]	IRC CRI	Flusso lum. Lum. flux [lm]	Efficienza lum. Lum. effic. [lm / W]	Dimensioni / Dimensions [mm]				Cod. / Code LED	Cod. / Code LED DALI
					A (Ø)	B	C	D (Ø)		
○ Bianco dry / Dry white										
7	3000	>80	700	100	55	350	22	100	363800021	363800022
7	4000	>80	760	108	55	350	22	100	363800023	363800024
7	3000	>80	700	100	55	500	22	100	363800025	363800026
7	4000	>80	760	108	55	500	22	100	363800027	363800028
● Nero dry / Dry black										
7	3000	>80	700	100	55	350	22	100	363800013	363800014
7	4000	>80	760	108	55	350	22	100	363800015	363800016
7	3000	>80	700	100	55	500	22	100	363800017	363800018
7	4000	>80	760	108	55	500	22	100	363800019	363800020

Circle

IP40

UGR
<19

Caratteristiche tecniche

Technical Characteristics

Corpo	Profilo estruso in alluminio (6060)	Body	Extruded aluminium profile (6060)
Colore	<ul style="list-style-type: none"> ○ Bianco opaco (RAL 9010) ● Nero opaco (RAL 9005) Su richiesta: <ul style="list-style-type: none"> ● Metallizzati ● Altri colori 	Colour	<ul style="list-style-type: none"> ○ Matt white (RAL 9010) ● Matt black (RAL 9005) On request: <ul style="list-style-type: none"> ● Metallic ● Other colours available
Gruppo ottico	<ul style="list-style-type: none"> · PMO - policarbonato microprismatico (UGR<19) · MOT - metacrilato opale 	Optical group	<ul style="list-style-type: none"> · PMO - microprismatic polycarbonate (UGR<19) · MOT - opal methacrylate
Cablaggio	<ul style="list-style-type: none"> · LED ON/OFF con driver integrato · LED DALI con driver integrato Su richiesta: <ul style="list-style-type: none"> · Circuito RGB DMX · Kit di EMERGENZA (autonomia 1/3 h) 	Wiring	<ul style="list-style-type: none"> · LED ON/OFF with integrated driver · LED DALI with integrated driver On request: <ul style="list-style-type: none"> · DMX RGB circuit · EMERGENCY kit (1/3 h autonomy)
Grado di protezione	· IP 40	Protection degree	· IP 40

Sorgenti LED

LED sources

IRC	<ul style="list-style-type: none"> · >80 Su richiesta: <ul style="list-style-type: none"> · >90 	CRI	<ul style="list-style-type: none"> · >80 On request: <ul style="list-style-type: none"> · >90
Temp. colore	<ul style="list-style-type: none"> · 3000 K · 4000 K Su richiesta: <ul style="list-style-type: none"> · TUNABLE WHITE 2700-6500 K · LED RGB 	Colour Temp.	<ul style="list-style-type: none"> · 3000 K · 4000 K On request: <ul style="list-style-type: none"> · TUNABLE WHITE 2700-6500 K · RGB LED

Ottiche Diffusers

PMO

Diffusore in policarbonato microprismatico anabbagliante. Valori di luminanza < 3000 cd/m² per angoli > 65°. Film interno in policarbonato opale anabbagliante per una maggiore uniformità luminosa. Conforme ad essere installata in ambienti con uso di videoterminali secondo la norma UNI EN 12464-1.

Diffuser made of anti-glare microprismatic polycarbonate. Luminance values <3000 cd/m² for angles >65°. Internal anti-glare opal polycarbonate film for a better light uniformity. Suitable for installation in workplaces with the use of video terminals according to EN 12464-1 standard.

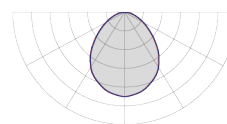

UGR
<19



MOT

Diffusore in metacrilato opale ad alta trasmittanza, ideale per una distribuzione uniforme.

Diffuser in opal methacrylate with high transmittance, ideal for uniform distribution.

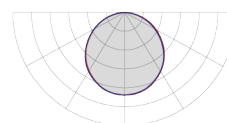

Accessori (da ordinare separatamente) Accessories (to be ordered separately)

Sospensione / Suspension



L= 2000 mm

KIT DI SOSPENSIONE BIANCO WHITE SUSPENSION KIT

Cod. / Code **KS20126x**

Rosone tondo elettrificato (Ø 100mm x H. 22mm) di colore bianco opaco (RAL 9010) con morsettiera; cavi di sospensione metallici (pz.2/kit) e cavo elettrificato trasparente
Electrified round ceiling rose (Ø 100mm x H. 22mm) matt white powder coated (RAL 9010) with connection terminal block; suspension cables (pcs.2/kit) and transparent power cable

- **3** - cavo di alimentazione a 3 poli (ON/OFF) / 3 poles feeding cable (ON/OFF)
- **5** - cavo di alimentazione a 5 poli (DALI e ON/OFF + emergenza) / 5 poles feeding cable (DALI and ON/OFF + emergency)



L= 2000 mm

KIT DI SOSPENSIONE NERO BLACK SUSPENSION KIT

Cod. / Code **KS20130x**

Rosone tondo elettrificato (Ø 100mm x H. 22mm) di colore nero opaco (RAL 9005) con morsettiera; cavi di sospensione metallici (pz.2/kit) e cavo elettrificato trasparente
Electrified round ceiling rose (Ø 100mm x H. 22mm) matt black powder coated (RAL 9005) with connection terminal block; suspension cables (pcs.2/kit) and transparent power cable

- **3** - cavo di alimentazione a 3 poli (ON/OFF) / 3 poles feeding cable (ON/OFF)
- **5** - cavo di alimentazione a 5 poli (DALI e ON/OFF + emergenza) / 5 poles feeding cable (DALI and ON/OFF + emergency)

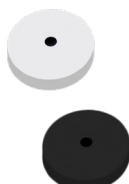

Ø= 100 mm
H= 22 mm

ROSONE TONDO ELETRIFICATO ELECTRIFIED ROUND CEILING ROSE

Cod. / Code **KS200xM**

Lamiera d'acciaio verniciato, 1 foro per il passaggio del cavo di alimentazione con morsettiera di connessione
Powder coated sheet-steel ceiling rose with connection terminal block terminal block

- **26** : Colore bianco opaco (RAL 9010) / Matt white colour (RAL 9010)
- **30** : Colore nero opaco (RAL 9005) / Matt black colour (RAL 9005)



L= 2000 mm

CAVO DI SOSPENSIONE SUSPENSION CABLE

Cod. / Code **KS001**

È necessario ordinare 3 pz. per ogni lampada
It is necessary to order 3 pcs. for each lamp



L= 2000 mm
Ø= 0,75 mmq

CAVO DI ALIMENTAZIONE TRASPARENTE TRANSPARENT ELECTRIFIED FEEDING CABLE

Cod. / Code **CVTxx075L020**

- **3** poli (ON/OFF) / poles (ON/OFF)
- **5** poli (DALI e ON/OFF + emergenza) / poles (DALI and ON/OFF + emergency)
- **7** poli (DALI + emergenza) / poles (DALI + emergency)

PMO

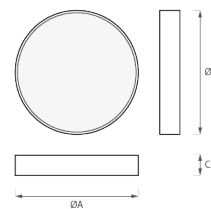
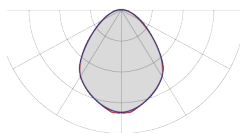

Potenza Power [W]	Temp. colore Colour Temp. [K]	IRC CRI	Flusso lum. Lum. flux [lm]	Efficienza lum. Lum. effic. [lm / W]	Dimensioni / Dimensions [mm]		Cod. / Code LED	Cod. / Code LED DALI
					A (Ø)	C		
○ RAL 9010								
25	3000	>80	3760	150	450	140	364100115	364100117
25	4000	>80	3960	158	450	140	364100119	364100121
28	3000	>80	4000	143	610	140	364100123	364100125
28	4000	>80	4225	151	610	140	364100127	364100129
57	3000	>80	8060	141	850	140	364100131	364100133
57	4000	>80	8510	149	850	140	364100135	364100137
102	3000	>80	14525	142	1130	140	364100139	364100141
102	4000	>80	15360	151	1130	140	364100143	364100145
● RAL 9005								
25	3000	>80	3760	150	450	140	364100114	364100116
25	4000	>80	3960	158	450	140	364100118	364100120
28	3000	>80	4000	143	610	140	364100122	364100124
28	4000	>80	4225	151	610	140	364100126	364100128
57	3000	>80	8060	141	850	140	364100130	364100132
57	4000	>80	8510	149	850	140	364100134	364100136
102	3000	>80	14525	142	1130	140	364100138	364100140
102	4000	>80	15360	151	1130	140	364100142	364100144

MOT

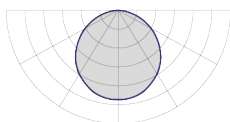

Potenza Power [W]	Temp. colore Colour Temp. [K]	IRC CRI	Flusso lum. Lum. flux [lm]	Efficienza lum. Lum. effic. [lm / W]	Dimensioni / Dimensions [mm]		Cod. / Code LED	Cod. / Code LED DALI
					A (Ø)	C		
○ RAL 9010								
25	3000	>80	3575	143	450	140	364100045	364100047
25	4000	>80	3760	150	450	140	364100049	364100051
28	3000	>80	3800	136	610	140	364100053	364100055
28	4000	>80	4015	143	610	140	364100057	364100059
57	3000	>80	7660	134	850	140	364100061	364100063
57	4000	>80	8085	141	850	140	364100065	364100067
102	3000	>80	13800	135	1130	140	364100069	364100071
102	4000	>80	14590	143	1130	140	364100073	364100075
● RAL 9005								
25	3000	>80	3575	143	450	140	364100044	364100046
25	4000	>80	3760	150	450	140	364100048	364100050
28	3000	>80	3800	136	610	140	364100052	364100054
28	4000	>80	4015	143	610	140	364100056	364100058
57	3000	>80	7660	134	850	140	364100060	364100062
57	4000	>80	8085	141	850	140	364100064	364100066
102	3000	>80	13800	135	1130	140	364100068	364100070
102	4000	>80	14590	143	1130	140	364100072	364100074



Cosmo

IP40

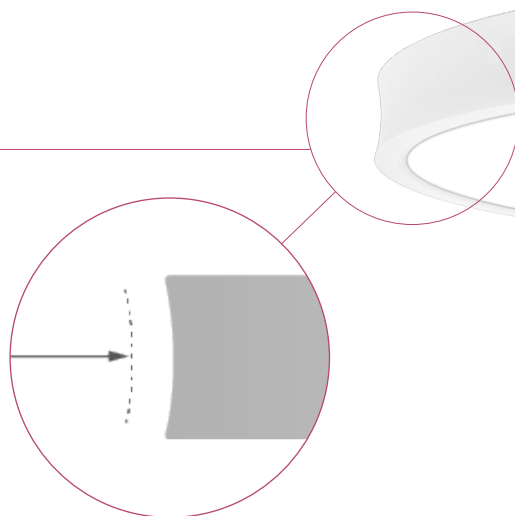
UGR
<19

Caratteristiche tecniche

Technical Characteristics

Corpo	Profilo estruso in alluminio (6060)	Body	Extruded aluminium profile (6060)
Colore	<input type="radio"/> Bianco opaco (RAL 9010) <input checked="" type="radio"/> Nero opaco (RAL 9005) Su richiesta: <input type="radio"/> Metallizzati <input type="radio"/> Altri colori	Colour	<input type="radio"/> Matt white (RAL 9010) <input checked="" type="radio"/> Matt black (RAL 9005) On request: <input type="radio"/> Metallic <input type="radio"/> Other colours available
Gruppo ottico	<ul style="list-style-type: none"> PMO - policarbonato microprismatico (UGR<19) MOT - metacrilato opale 	Optical group	<ul style="list-style-type: none"> PMO - microprismatic polycarbonate (UGR<19) MOT - opal methacrylate
Cablaggio	<ul style="list-style-type: none"> LED ON/OFF con driver integrato LED DALI con driver integrato Su richiesta: <ul style="list-style-type: none"> Circuito RGB DMX Kit di EMERGENZA (autonomia 1/3 h) 	Wiring	<ul style="list-style-type: none"> LED ON/OFF with integrated driver LED DALI with integrated driver On request: <ul style="list-style-type: none"> DMX RGB circuit EMERGENCY kit (1/3 h autonomy)
Grado di protezione	<ul style="list-style-type: none"> IP 40 	Protection degree	<ul style="list-style-type: none"> IP 40

Sorgenti LED

LED sources

IRC	<ul style="list-style-type: none"> >80 Su richiesta: <ul style="list-style-type: none"> >90 	CRI	<ul style="list-style-type: none"> >80 On request: <ul style="list-style-type: none"> >90
Temp. colore	<ul style="list-style-type: none"> 3000 K 4000 K Su richiesta: <ul style="list-style-type: none"> TUNABLE WHITE 2700-6500 K LED RGB 	Colour Temp.	<ul style="list-style-type: none"> 3000 K 4000 K On request: <ul style="list-style-type: none"> TUNABLE WHITE 2700-6500 K RGB LED

Ottiche Diffusers

PMO

Diffusore in policarbonato microprismatico anabbagliante. Valori di luminanza < 3000 cd/m² per angoli > 65°. Film interno in policarbonato opale anabbagliante per una maggiore uniformità luminosa. Conforme ad essere installata in ambienti con uso di videoterminali secondo la norma UNI EN 12464-1.

Diffuser made of anti-glare microprismatic polycarbonate. Luminance values <3000 cd/m² for angles >65°. Internal anti-glare opal polycarbonate film for a better light uniformity. Suitable for installation in workplaces with the use of video terminals according to EN 12464-1 standard.

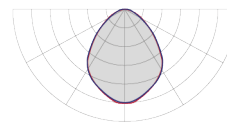

UGR
<19



MOT

Diffusore in metacrilato opale ad alta trasmittanza, ideale per una distribuzione uniforme.

Diffuser in opal methacrylate with high transmittance, ideal for uniform distribution.

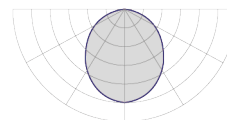

Accessori (da ordinare separatamente)

Accessories (to be ordered separately)

Sospensione / Suspension



L= 2000 mm

KIT DI SOSPENSIONE BIANCO WHITE SUSPENSION KIT

Cod. / Code **KS20226x**

Rosone tondo elettrificato (Ø 100mm x H. 22mm) di colore bianco opaco (RAL 9010) con morsettiera; cavi di sospensione metallici (pz.2/kit) e cavo elettrificato trasparente
Electrified round ceiling rose (Ø 100mm x H. 22mm) matt white powder coated (RAL 9010) with connection terminal block; suspension cables (pcs.2/kit) and transparent power cable

- **3** - cavo di alimentazione a 3 poli (ON/OFF) / 3 poles feeding cable (ON/OFF)
- **5** - cavo di alimentazione a 5 poli (DALI e ON/OFF + emergenza) / 5 poles feeding cable (DALI and ON/OFF + emergency)



L= 2000 mm

KIT DI SOSPENSIONE NERO BLACK SUSPENSION KIT

Cod. / Code **KS20230x**

Rosone tondo elettrificato (Ø 100mm x H. 22mm) di colore nero opaco (RAL 9005) con morsettiera; cavi di sospensione metallici (pz.2/kit) e cavo elettrificato trasparente
Electrified round ceiling rose (Ø 100mm x H. 22mm) matt black powder coated (RAL 9005) with connection terminal block; suspension cables (pcs.2/kit) and transparent power cable

- **3** - cavo di alimentazione a 3 poli (ON/OFF) / 3 poles feeding cable (ON/OFF)
- **5** - cavo di alimentazione a 5 poli (DALI e ON/OFF + emergenza) / 5 poles feeding cable (DALI and ON/OFF + emergency)

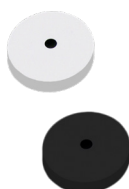

Ø= 100 mm
H= 22 mm

ROSONE TONDO ELETRIFICATO ELECTRIFIED ROUND CEILING ROSE

Cod. / Code **KS200xM**

Lamiera d'acciaio verniciato, 1 foro per il passaggio del cavo di alimentazione con morsettiera di connessione
Powder coated sheet-steel ceiling rose with connection terminal block terminal block

- **26** : Colore bianco opaco (RAL 9010) / Matt white colour (RAL 9010)
- **30** : Colore nero opaco (RAL 9005) / Matt black colour (RAL 9005)



L= 2000 mm

CAVO DI SOSPENSIONE SUSPENSION CABLE

Cod. / Code **KS001**

È necessario ordinare 4 pz. per ogni lampada
It is necessary to order 4 pcs. for each lamp



L= 2000 mm
Ø= 0,75 mmq

CAVO DI ALIMENTAZIONE TRASPARENTE TRANSPARENT ELECTRIFIED FEEDING CABLE

Cod. / Code **CVTxX075L020**

- **3** poli (ON/OFF) / poles (ON/OFF)
- **5** poli (DALI e ON/OFF + emergenza) / poles (DALI and ON/OFF + emergency)
- **7** poli (DALI + emergenza) / poles (DALI + emergency)

PMO

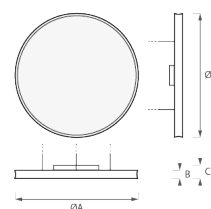
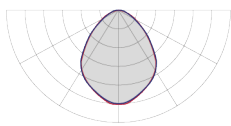

Potenza Power [W]	Temp. colore Colour Temp. [K]	IRC CRI	Flusso lum. Lum. flux [lm]	Efficienza lum. Lum. effic. [lm / W]	Dimensioni / Dimensions [mm]			Cod. / Code LED	Cod. / Code LED DALI
					A (∅)	B	C		
○ RAL 9010									
28	3000	>80	4000	143	610	57	83	352500130	352500132
28	4000	>80	4225	151	610	57	83	352500134	352500136
57	3000	>80	8060	141	850	57	83	352500138	352500140
57	4000	>80	8510	149	850	57	83	352500142	352500144
102	3000	>80	14525	142	1130	57	83	352500146	352500148
102	4000	>80	15360	151	1130	57	83	352500150	352500152
● RAL 9005									
28	3000	>80	4000	143	610	57	83	352500131	352500133
28	4000	>80	4225	151	610	57	83	352500135	352500137
57	3000	>80	8060	141	850	57	83	352500139	352500141
57	4000	>80	8510	149	850	57	83	352500143	352500145
102	3000	>80	14525	142	1130	57	83	352500147	352500149
102	4000	>80	15360	151	1130	57	83	352500151	352500127

MOT

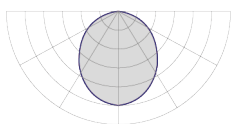

Potenza Power [W]	Temp. colore Colour Temp. [K]	IRC CRI	Flusso lum. Lum. flux [lm]	Efficienza lum. Lum. effic. [lm / W]	Dimensioni / Dimensions [mm]			Cod. / Code LED	Cod. / Code LED DALI
					A (∅)	B	C		
○ RAL 9010									
28	3000	>80	3800	136	610	57	83	352500047	352500049
28	4000	>80	4015	143	610	57	83	352500051	352500053
57	3000	>80	7660	134	850	57	83	352500055	352500057
57	4000	>80	8085	141	850	57	83	352500059	352500061
102	3000	>80	13800	135	1130	57	83	352500063	352500065
102	4000	>80	14590	143	1130	57	83	352500067	352500069
● RAL 9005									
28	3000	>80	3800	136	610	57	83	352500046	352500048
28	4000	>80	4015	143	610	57	83	352500050	352500052
57	3000	>80	7660	134	850	57	83	352500054	352500056
57	4000	>80	8085	141	850	57	83	352500058	352500060
102	3000	>80	13800	135	1130	57	83	352500062	352500064
102	4000	>80	14590	143	1130	57	83	352500066	352500068



Pigreco

IP40

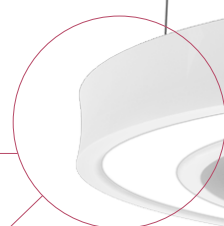
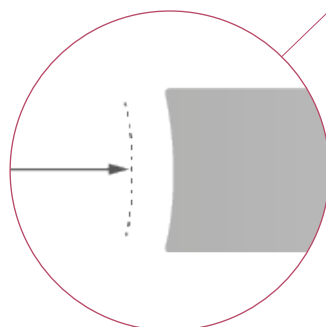

Caratteristiche tecniche

Technical Characteristics

Corpo	Profilo estruso in alluminio (6060)	Body	Extruded aluminium profile (6060)
Colore	<input type="radio"/> Bianco opaco (RAL 9010) <input checked="" type="radio"/> Nero opaco (RAL 9005) <u>Su richiesta:</u> <input type="radio"/> Metallizzati <input type="radio"/> Altri colori	Colour	<input type="radio"/> Matt white (RAL 9010) <input checked="" type="radio"/> Matt black (RAL 9005) <u>On request:</u> <input type="radio"/> Metallic <input type="radio"/> Other colours available
Gruppo ottico	· MOT - metacrilato opale	Optical group	· MOT - opal methacrylate
Cablaggio	· LED ON/OFF con driver integrato · LED DALI con driver integrato <u>Su richiesta:</u> · Circuito RGB DMX · Kit di EMERGENZA (autonomia 1/3 h)	Wiring	· LED ON/OFF with integrated driver · LED DALI with integrated driver <u>On request:</u> · DMX RGB circuit · EMERGENCY kit (1/3 h autonomy)
Grado di protezione	· IP 40	Protection degree	· IP 40

Sorgenti LED

LED sources

IRC	· >80 <u>Su richiesta:</u> · >90	CRI	· >80 <u>On request:</u> · >90
Temp. colore	· 3000 K · 4000 K <u>Su richiesta:</u> · TUNABLE WHITE 2700-6500 K · LED RGB	Colour Temp.	· 3000 K · 4000 K <u>On request:</u> · TUNABLE WHITE 2700-6500 K · RGB LED

Ottiche

Diffusers

MOT

Diffusori in metacrilato opale ad alta trasmittanza, ideale per una distribuzione uniforme.

Diffusers in opal methacrylate with high transmittance, ideal for uniform distribution.

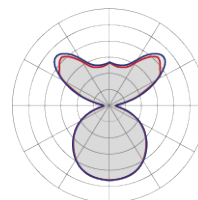

Accessori (da ordinare separatamente)
Accessories (to be ordered separately)

Sospensione / Suspension



L= 2000 mm

KIT DI SOSPENSIONE BIANCO
WHITE SUSPENSION KIT

Cod. / Code KS20126x
 Rosone tondo elettrificato (Ø 100mm x H. 22mm) di colore bianco opaco (RAL 9010) con morsettiera; cavi di sospensione metallici (pz.2/kit) e cavo elettrificato trasparente
Electrified round ceiling rose (Ø 100mm x H. 22mm) matt white powder coated (RAL 9010) with connection terminal block; suspension cables (pcs.2/kit) and transparent power cable

- **3** - cavo di alimentazione a 3 poli (ON/OFF)/ 3 poles feeding cable (ON/OFF)
- **5** - cavo di alimentazione a 5 poli (DALI e ON/OFF + emergenza) / 5 poles feeding cable (DALI and ON/OFF + emergency)

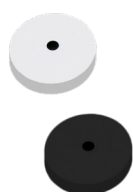

Ø= 100 mm
 H= 22 mm

ROSONE TONDO ELETRIFICATO
ELECTRIFIED ROUND CEILING ROSE

Cod. / Code KS200xM
 Lamiera d'acciaio verniciato, 1 foro per il passaggio del cavo di alimentazione con morsettiera di connessione
Powder coated sheet-steel ceiling rose with connection terminal block terminal block

- **26**: Colore bianco opaco (RAL 9010) / Matt white colour (RAL 9010)
- **30**: Colore nero opaco (RAL 9005) / Matt black colour (RAL 9005)



L= 2000 mm

KIT DI SOSPENSIONE NERO
BLACK SUSPENSION KIT

Cod. / Code KS20130x
 Rosone tondo elettrificato (Ø 100mm x H. 22mm) di colore nero opaco (RAL 9005) con morsettiera; cavi di sospensione metallici (pz.2/kit) e cavo elettrificato trasparente
Electrified round ceiling rose (Ø 100mm x H. 22mm) matt black powder coated (RAL 9005) with connection terminal block; suspension cables (pcs.2/kit) and transparent power cable

- **3** - cavo di alimentazione a 3 poli (ON/OFF)/ 3 poles feeding cable (ON/OFF)
- **5** - cavo di alimentazione a 5 poli (DALI e ON/OFF + emergenza) / 5 poles feeding cable (DALI and ON/OFF + emergency)



L= 2000 mm

CAVO DI SOSPENSIONE
SUSPENSION CABLE

Cod. / Code KS001
 È necessario ordinare 3 pz. per ogni lampada
It is necessary to order 3 pcs. for each lamp



L= 2000 mm
 Ø= 0,75 mmq

CAVO DI ALIMENTAZIONE TRASPARENTE
TRANSPARENT ELECTRIFIED FEEDING CABLE

Cod. / Code CVTxx075L020

- **3** poli (ON/OFF)/poles (ON/OFF)
- **5** poli (DALI e ON/OFF + emergenza)/ poles (DALI and ON/OFF + emergency)
- **7** poli (DALI + emergenza)/ poles (DALI + emergency)

MOT

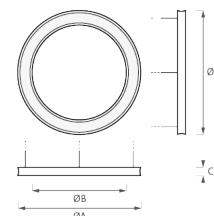
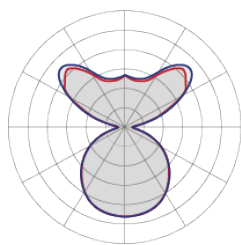

Potenza Power [W]	Temp. colore Colour Temp. [K]	IRC CRI	Flusso lum. Lum. flux [lm]	Efficienza lum. Lum. effic. [lm / W]	Dimensioni / Dimensions [mm]			Cod. / Code LED	Cod. / Code LED DALI
					A (Ø)	B (Ø)	C		
○ RAL 9010									
100	3000	>80	5200	52	850	650	57	364300029	364300030
100	4000	>80	5700	57	850	650	57	364300031	364300032
160	3000	>80	8320	52	1300	1100	57	364300033	364300034
160	4000	>80	9120	57	1300	1100	57	364300035	364300036
215	3000	>80	11180	52	1700	1500	57	364300037	364300038
215	4000	>80	12255	57	1700	1500	57	364300039	364300040
● RAL 9005									
100	3000	>80	5200	52	850	650	57	364300016	364300017
100	4000	>80	5700	57	850	650	57	364300010	364300011
160	3000	>80	8320	52	1300	1100	57	364300019	364300020
160	4000	>80	9120	57	1300	1100	57	364300008	364300018
215	3000	>80	11180	52	1700	1500	57	364300021	364300022
215	4000	>80	12255	57	1700	1500	57	364300009	364300012

1) Il flusso effettivo potrebbe avere una tolleranza del ±10%. / The effective flux could have a tolerance of ±10%.



TERRA e PARETE *FLOOR and WALL*

Stair

IP40

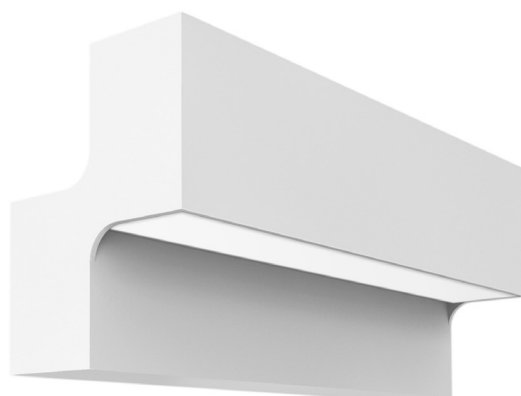

Caratteristiche tecniche

Technical Characteristics

Corpo	Profilo estruso in alluminio	Body	Extruded aluminium profile
Colore	<ul style="list-style-type: none"> ○ Bianco Dry <u>Su richiesta:</u> ● Altri colori 	Colour	<ul style="list-style-type: none"> ○ Dry white <u>On request:</u> ● Other colours available
Gruppo ottico	<ul style="list-style-type: none"> · PST - policarbonato opale satinato 	Optical group	<ul style="list-style-type: none"> · PST - glazed opal polycarbonate
Cablaggio	<ul style="list-style-type: none"> · LED ON/OFF con driver integrato · LED DALI con driver integrato <u>Su richiesta:</u> · Kit di EMERGENZA (autonomia 1/3 h) 	Wiring	<ul style="list-style-type: none"> · LED ON/OFF with integrated driver · LED DALI with integrated driver <u>On request:</u> · EMERGENCY kit (1/3 h autonomy)
Grado di protezione	<ul style="list-style-type: none"> · IP 40 	Protection degree	<ul style="list-style-type: none"> · IP 40

Sorgenti LED

LED sources

IRC	<ul style="list-style-type: none"> · >80 <u>Su richiesta:</u> · >90 	CRI	<ul style="list-style-type: none"> · >80 <u>On request:</u> · >90
Temp. colore	<ul style="list-style-type: none"> · 3000 K · 4000 K <u>Su richiesta:</u> · TUNABLE WHITE 2700-6500 K 	Colour Temp.	<ul style="list-style-type: none"> · 3000 K · 4000 K <u>On request:</u> · TUNABLE WHITE 2700-6500 K

Ottiche

Diffusers

PST

Diffusore in policarbonato opale satinato a finitura liscia, ideale per una distribuzione uniforme.

Diffuser in glazed opal polycarbonate with smooth finish, ideal for uniform distribution.

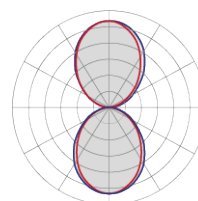

PST

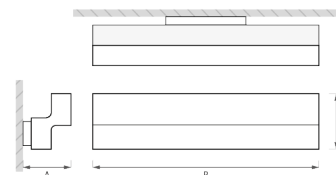
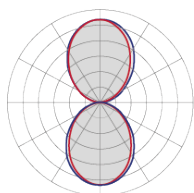

Versioni standard Standard versions



Potenza Power [W]	Temp. colore Colour Temp. [K]	IRC CRI	Flusso lum. Lum. flux [lm]		Efficienza lum. Lum. effic. [lm / W]	Dimensioni/Dimensions [mm]			Cod. /Code LED	Cod. /Code LED DALI
			↑	↓		A	B	C		
↑12 ↓12	3000	>80	↑1020	↓1020	↑85 ↓85	120	320	138	666000066	666000067
↑12 ↓12	4000	>80	↑1092	↓1092	↑91 ↓91	120	320	138	666000068	666000069
↑13 ↓13	3000	>80	↑1105	↓1105	↑85 ↓85	120	561	138	666000070	666000071
↑13 ↓13	4000	>80	↑1183	↓1183	↑91 ↓91	120	561	138	666000072	666000073
↑20 ↓20	3000	>80	↑1700	↓1700	↑85 ↓85	120	841	138	666000074	666000075
↑20 ↓20	4000	>80	↑1820	↓1820	↑91 ↓91	120	841	138	666000076	666000077
↑26 ↓26	3000	>80	↑2210	↓2210	↑85 ↓85	120	1121	138	666000078	666000079
↑26 ↓26	4000	>80	↑2366	↓2366	↑91 ↓91	120	1121	138	666000080	666000081
↑33 ↓33	3000	>80	↑2805	↓2805	↑85 ↓85	120	1401	138	666000082	666000083
↑33 ↓33	4000	>80	↑3003	↓3003	↑91 ↓91	120	1401	138	666000084	666000085



Versioni in doppia o tripla accensione, ideali anche per ambienti di degenza ospedaliera

Versions with double or triple ignition,
also ideal for hospital environments



Potenza Power [W]	Temp. colore Colour Temp. [K]	IRC CRI	Flusso lum. Lum. flux [lm]		Efficienza lum. Lum. effic. [lm / W]	Dimensioni/Dimensions [mm]			Cod. /Code LED	Cod. /Code LED DALI	
			↑	↓		A	B	C			
↑13 ↓13	-	3000	↑1105	↓1105	↑85 ↓85	120	600	138	666000086	666000087	
↑13 ↓13	-	4000	↑1183	↓1183	↑91 ↓91	120	600	138	666000088	666000089	
↑13 ↓13	3	3000	↑1105	↓1105	340	↑85 ↓85	120	600	138	666000090	666000091
↑13 ↓13	3	4000	↑1183	↓1183	360	↑91 ↓91	120	600	138	666000092	666000093
↑20 ↓20	-	3000	↑1700	↓1700	-	↑85 ↓85	120	900	138	666000094	666000095
↑20 ↓20	-	4000	↑1820	↓1820	-	↑91 ↓91	120	900	138	666000096	666000097
↑20 ↓20	3	3000	↑1700	↓1700	340	↑85 ↓85	120	900	138	666000098	666000099
↑20 ↓20	3	4000	↑1820	↓1820	360	↑91 ↓91	120	900	138	666000100	666000101
↑26 ↓26	-	3000	↑2210	↓2210	-	↑85 ↓85	120	1200	138	666000102	666000103
↑26 ↓26	-	4000	↑2366	↓2366	-	↑91 ↓91	120	1200	138	666000104	666000105
↑26 ↓26	3	3000	↑2210	↓2210	340	↑85 ↓85	120	1200	138	666000106	666000107
↑26 ↓26	3	4000	↑2366	↓2366	360	↑91 ↓91	120	1200	138	666000108	666000109

↑ Luce indiretta/Indirect light

↓ Luce diretta/Direct light

■ Luce notturna/Night light

I) Versioni standard in accensione singola/ Standard Versions with single ignition

II) Il flusso effettivo potrebbe avere una tolleranza del ±10%. / The effective flux could have a tolerance of ±10%.

Way Wall

IP40

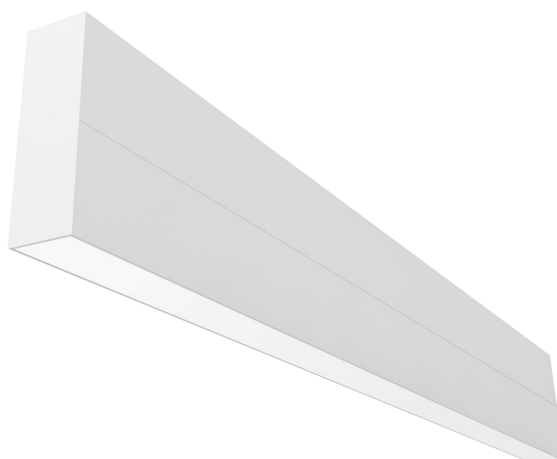

Caratteristiche tecniche

Technical Characteristics

Corpo	Profilo estruso in alluminio	Body	Extruded aluminium profile
Colore	<ul style="list-style-type: none"> ○ Bianco Dry <u>Su richiesta:</u> ● Altri colori 	Colour	<ul style="list-style-type: none"> ○ Dry white <u>On request:</u> ● Other colours available
Gruppo ottico	<ul style="list-style-type: none"> · PST - policarbonato opale satinato 	Optical group	<ul style="list-style-type: none"> · PST - glazed opal polycarbonate
Cablaggio	<ul style="list-style-type: none"> · LED ON/OFF con driver integrato · LED DALI con driver integrato <u>Su richiesta:</u> · Kit di EMERGENZA (autonomia 1/3 h) 	Wiring	<ul style="list-style-type: none"> · LED ON/OFF with integrated driver · LED DALI with integrated driver <u>On request:</u> · EMERGENCY kit (1/3 h autonomy)
Grado di protezione	<ul style="list-style-type: none"> · IP 40 	Protection degree	<ul style="list-style-type: none"> · IP 40

Sorgenti LED

LED sources

IRC	<ul style="list-style-type: none"> · >80 <u>Su richiesta:</u> · >90 	CRI	<ul style="list-style-type: none"> · >80 <u>On request:</u> · >90
Temp. colore	<ul style="list-style-type: none"> · 3000 K · 4000 K <u>Su richiesta:</u> · TUNABLE WHITE 2700-6500 K 	Colour Temp.	<ul style="list-style-type: none"> · 3000 K · 4000 K <u>On request:</u> · TUNABLE WHITE 2700-6500 K

Ottiche

Diffusers

PST

Diffusore in policarbonato opale satinato a finitura liscia, ideale per una distribuzione uniforme.

Diffuser in glazed opal polycarbonate with smooth finish, ideal for uniform distribution.

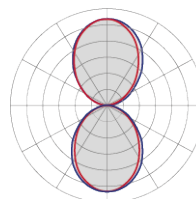

Accessori (da ordinare separatamente)

Accessories (to be ordered separately)



2 pcs. kit

TESTATE DI CHIUSURA

END CAPS

Cod. / Code TC663004

Alluminio verniciato di colore bianco Dry.
Dry white powder coated.



2 pcs. kit

STAFFA D'UNIONE

UNION BRACKET

Cod. / Code KFS663000

Per l'installazione in linea continua, in acciaio zincato. Completo di viti di fissaggio.

Galvanized steel union bracket for continuous line installation. Fixing screws included.

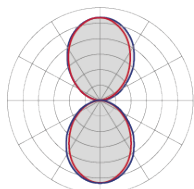

PST

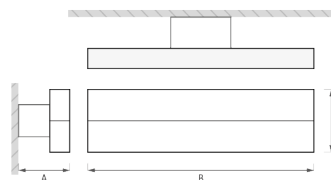

Versioni standard

Standard versions



Potenza Power [W]	Temp. colore Colour Temp. [K]	IRC CRI	Flusso lum. Lum. flux [lm]	Efficienza lum. Lum. effic. [lm / W]	Dimensioni/Dimensions [mm]			Cod. /Code LED	Cod./Code LED DALI
					A	B	C		
↑13 ↓13	3000	>80	↑1105 ↓1105	↑85 ↓85	128	561	156	663000552	663000553
↑13 ↓13	4000	>80	↑1183 ↓1183	↑91 ↓91	128	561	156	663000559	663000560
↑20 ↓20	3000	>80	↑1700 ↓1700	↑85 ↓85	128	841	156	663000554	663000555
↑20 ↓20	4000	>80	↑1820 ↓1820	↑91 ↓91	128	841	156	663000562	663000563
↑26 ↓26	3000	>80	↑2210 ↓2210	↑85 ↓85	128	1121	156	663000556	663000557
↑26 ↓26	4000	>80	↑2366 ↓2366	↑91 ↓91	128	1121	156	663000564	663000565
↑39 ↓39	3000	>80	↑3315 ↓3315	↑85 ↓85	128	1681	156	663000558	663000561
↑39 ↓39	4000	>80	↑3549 ↓3549	↑91 ↓91	128	1681	156	663000566	663000567

Versioni in doppia o tripla accensione, ideali anche per ambienti di degenza ospedaliera

Versions with double or triple ignition, also ideal for hospital environments



Potenza Power [W]	Temp. colore Colour Temp. [K]	IRC CRI	Flusso lum. Lum. flux [lm]	Efficienza lum. Lum. effic. [lm / W]	Dimensioni/Dimensions [mm]			Cod. /Code LED	Cod./Code LED DALI
					A	B	C		
↑13 ↓13	-	3000	↑1105 ↓1105	-	128	600	156	663000577	663000578
↑13 ↓13	-	4000	↑1183 ↓1183	-	128	600	156	663000579	663000580
↑13 ↓13	3	3000	↑1105 ↓1105	340	128	600	156	663000581	663000582
↑13 ↓13	3	4000	↑1183 ↓1183	360	128	600	156	663000583	663000584
↑20 ↓20	-	3000	↑1700 ↓1700	-	128	900	156	663000585	663000586
↑20 ↓20	-	4000	↑1820 ↓1820	-	128	900	156	663000587	663000588
↑20 ↓20	3	3000	↑1700 ↓1700	340	128	900	156	663000589	663000590
↑20 ↓20	3	4000	↑1820 ↓1820	360	128	900	156	663000591	663000592
↑26 ↓26	-	3000	↑2210 ↓2210	-	128	1200	156	663000593	663000594
↑26 ↓26	-	4000	↑2366 ↓2366	-	128	1200	156	663000595	663000596
↑26 ↓26	3	3000	↑2210 ↓2210	340	128	1200	156	663000597	663000598
↑26 ↓26	3	4000	↑2366 ↓2366	360	128	1200	156	663000599	663000600
↑39 ↓39	-	3000	↑3315 ↓3315	-	128	1800	156	663000601	663000602
↑39 ↓39	-	4000	↑3549 ↓3549	-	128	1800	156	663000603	663000604
↑39 ↓39	3	3000	↑3315 ↓3315	340	128	1800	156	663000605	663000606
↑39 ↓39	3	4000	↑3549 ↓3549	360	128	1800	156	663000607	663000608

↑ Luce indiretta/Indirect light

↓ Luce diretta/Direct light

■ Luce notturna/Night light

I) Versioni standard in accensione singola/ Standard Versions with single ignition

II) Il flusso effettivo potrebbe avere una tolleranza del ±10%. / The effective flux could have a tolerance of ±10%.

III) Le dimensioni fanno riferimento al solo modulo, escluse le testate di inizio e fine linea (+2mm cad.)/Dimensions refer to the module without the two end caps (+2mm each).

Skywall

IP40

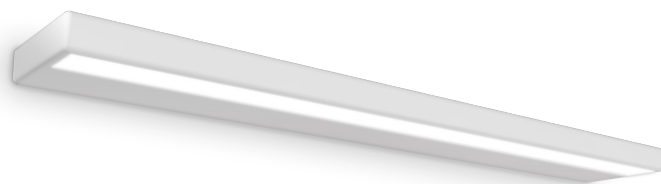

Caratteristiche tecniche

Technical Characteristics

Corpo	<ul style="list-style-type: none"> Profilo estruso in alluminio Testate di chiusura in ABS 	Body	<ul style="list-style-type: none"> Extruded aluminium profile ABS end-caps
Colore	<ul style="list-style-type: none"> <input type="radio"/> Bianco opaco (RAL9003) <p><u>Su richiesta:</u></p> <ul style="list-style-type: none"> <input checked="" type="radio"/> Altri colori 	Colour	<ul style="list-style-type: none"> <input type="radio"/> Matt white (RAL9003) <p><u>On request:</u></p> <ul style="list-style-type: none"> <input checked="" type="radio"/> Other colours available
Gruppo ottico	<ul style="list-style-type: none"> PST - Policarbonato opale satinato 	Optical group	<ul style="list-style-type: none"> PST - Glazed opal polycarbonate
Cablaggio	<ul style="list-style-type: none"> LED ON/OFF con driver integrato LED DALI con driver integrato <p><u>Su richiesta:</u></p> <ul style="list-style-type: none"> Kit di EMERGENZA (autonomia 1/3 h) 	Wiring	<ul style="list-style-type: none"> LED ON/OFF with integrated driver LED DALI with integrated driver <p><u>On request:</u></p> <ul style="list-style-type: none"> EMERGENCY kit (1/3 h autonomy)
Grado di protezione	<ul style="list-style-type: none"> IP 40 	Protection degree	<ul style="list-style-type: none"> IP 40

Sorgenti LED

LED sources

IRC	<ul style="list-style-type: none"> >80 <p><u>Su richiesta:</u></p> <ul style="list-style-type: none"> >90 	CRI	<ul style="list-style-type: none"> >80 <p><u>On request:</u></p> <ul style="list-style-type: none"> >90
Temp. colore	<ul style="list-style-type: none"> 3000 K 4000 K <p><u>Su richiesta:</u></p> <ul style="list-style-type: none"> TUNABLE WHITE 2700-6500 K 	Colour Temp.	<ul style="list-style-type: none"> 3000 K 4000 K <p><u>On request:</u></p> <ul style="list-style-type: none"> TUNABLE WHITE 2700-6500 K

Ottiche

Diffusers

PST

Diffusore in policarbonato opale satinato a finitura liscia, ideale per una distribuzione uniforme.

Diffuser in glazed opal polycarbonate with smooth finish, ideal for uniform distribution.

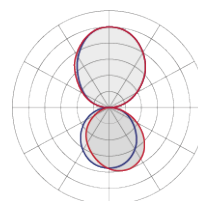

PST

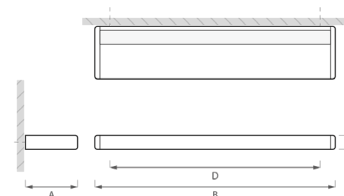
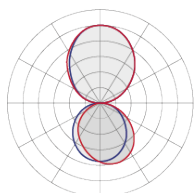

⁰¹ Versioni standard Standard versions



Potenza Power [W]	Temp. colore Colour Temp. [K]	IRC CRI	⁰¹ Flusso lum. Lum. flux [lm]	Efficienza lum. Lum. effic. [lm / W]	Dimensioni/Dimensions [mm]				Cod. /Code LED	Cod. /Code LED DALI
					A	B	C	D		
↑24 ↓24	3000	>80	↑2777 ↓2278	↑115 ↓94	130	600	35	525	402200033	402200034
↑24 ↓24	4000	>80	↑2996 ↓2424	↑124 ↓101	130	600	35	525	402200036	402200037
↑36 ↓36	3000	>80	↑4165 ↓3417	↑115 ↓94	130	900	35	825	402200039	402200040
↑36 ↓36	4000	>80	↑4494 ↓3634	↑124 ↓101	130	900	35	825	402200042	402200043
↑48 ↓48	3000	>80	↑5553 ↓4557	↑115 ↓94	130	1200	35	1125	402200045	402200046
↑48 ↓48	4000	>80	↑5991 ↓4847	↑124 ↓101	130	1200	35	1125	402200048	402200049



Versioni in doppia o tripla accensione, ideali anche per ambienti di degenza ospedaliera

Versions with double or triple ignition,
also ideal for hospital environments



Potenza Power [W]	Temp. colore Colour Temp. [K]	IRC CRI	⁰¹ Flusso lum. Lum. flux [lm]	Efficienza lum. Lum. effic. [lm / W]	Dimensioni/Dimensions [mm]				Cod. /Code LED	Cod. /Code LED DALI
					A	B	C	D		
↑24 ↓13	-	3000	↑2777 ↓1217	-	130	600	35	525	402200001	402200002
↑24 ↓13	-	4000	↑2996 ↓1313	-	130	600	35	525	402200003	402200004
↑24 ↓13	3	3000	↑2777 ↓1217	340	130	600	35	525	402200005	402200006
↑24 ↓13	3	4000	↑2996 ↓1313	360	130	600	35	525	402200007	402200008
↑36 ↓20	-	3000	↑4165 ↓1873	-	130	900	35	825	402200009	402200010
↑36 ↓20	-	4000	↑4494 ↓2020	-	130	900	35	825	402200011	402200012
↑36 ↓20	3	3000	↑4165 ↓1873	340	130	900	35	825	402200013	402200014
↑36 ↓20	3	4000	↑4494 ↓2020	360	130	900	35	825	402200015	402200016
↑48 ↓26	-	3000	↑5553 ↓2435	-	130	1200	35	1125	402200017	402200018
↑48 ↓26	-	4000	↑5991 ↓2626	-	130	1200	35	1125	402200019	402200020
↑48 ↓26	3	3000	↑5553 ↓2435	340	130	1200	35	1125	402200021	402200022
↑48 ↓26	3	4000	↑5991 ↓2626	360	130	1200	35	1125	402200023	402200024

↑ Luce indiretta/Indirect light

↓ Luce diretta/Direct light

■ Luce notturna/Night light

I) Versioni standard in accensione singola/ Standard Versions with single ignition

II) Il flusso effettivo potrebbe avere una tolleranza del ±10%. / The effective flux could have a tolerance of ±10%.

Horizon

IP40

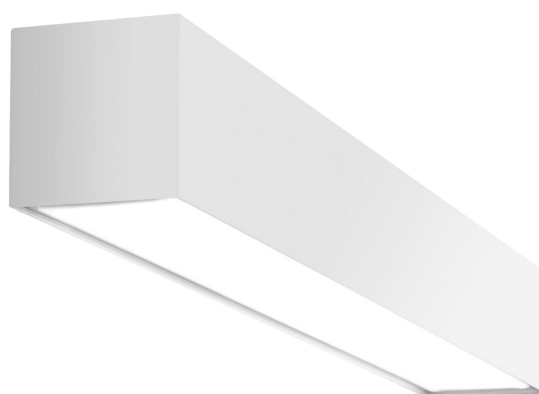

Caratteristiche tecniche

Technical Characteristics

Corpo	Lamiera di acciaio	Body	Sheet-steel
Colore	<ul style="list-style-type: none"> ○ Bianco Dry <u>Su richiesta:</u> ● Altri colori 	Colour	<ul style="list-style-type: none"> ○ Dry white <u>On request:</u> ● Other colours available
Gruppo ottico	<ul style="list-style-type: none"> · PTR - policarbonato trasparente (luce indiretta) · PST - policarbonato opale satinato (luce diretta) 	Optical group	<ul style="list-style-type: none"> · PTR - transparent polycarbonate (indirect light) · PST - glazed opal polycarbonate (direct light)
Cablaggio	<ul style="list-style-type: none"> · LED ON/OFF con driver integrato · LED DALI con driver integrato <u>Su richiesta:</u> · Kit di EMERGENZA (autonomia 1/3 h) 	Wiring	<ul style="list-style-type: none"> · LED ON/OFF with integrated driver · LED DALI with integrated driver <u>On request:</u> · EMERGENCY kit (1/3 h autonomy)
Grado di protezione	· IP 40	Protection degree	· IP 40

Sorgenti LED

LED sources

IRC	<ul style="list-style-type: none"> · >80 <u>Su richiesta:</u> · >90 	CRI	<ul style="list-style-type: none"> · >80 <u>On request:</u> · >90
Temp. colore	<ul style="list-style-type: none"> · 3000 K · 4000 K <u>Su richiesta:</u> · TUNABLE WHITE 2700-6500 K 	Colour Temp.	<ul style="list-style-type: none"> · 3000 K · 4000 K <u>On request:</u> · TUNABLE WHITE 2700-6500 K

Ottiche

Diffusers

PTR

Diffusore in policarbonato trasparente.
Diffuser in transparent.

PST

Diffusore in policarbonato opale satinato a finitura liscia, ideale per una distribuzione uniforme.
Diffuser in glazed opal polycarbonate with smooth finish, ideal for uniform distribution.

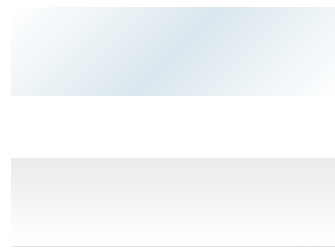
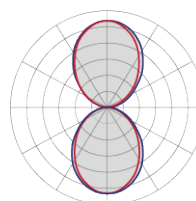

PTR PST

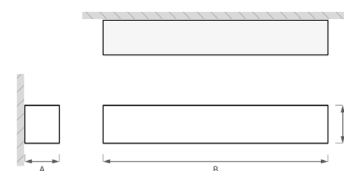
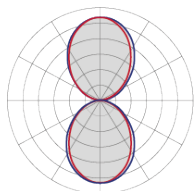

⁰¹ Versioni standard Standard versions



Potenza Power [W]	Temp. colore Colour Temp. [K]	IRC CRI	⁰¹ Flusso lum. Lum. flux [lm]	Efficienza lum. Lum. effic. [lm / W]	Dimensioni/Dimensions [mm]			Cod. /Code LED	Cod./Code LED DALI
					A	B	C		
↑13 ↓13	3000	>80	↑1443 ↓1118	↑111 ↓86	100	600	100	381100065	381100066
↑13 ↓13	4000	>80	↑1573 ↓1209	↑121 ↓93	100	600	100	381100067	381100068
↑20 ↓20	3000	>80	↑2220 ↓1720	↑111 ↓86	100	900	100	381100069	381100070
↑20 ↓20	4000	>80	↑2420 ↓1860	↑121 ↓93	100	900	100	381100071	381100072
↑26 ↓26	3000	>80	↑2886 ↓2236	↑111 ↓86	100	1200	100	381100073	381100074
↑26 ↓26	4000	>80	↑3146 ↓2418	↑121 ↓93	100	1200	100	381100075	381100076



Versioni in doppia o tripla accensione, ideali anche per ambienti di degenza ospedaliera

Versions with double or triple ignition,
also ideal for hospital environments



Potenza Power [W]	Temp. colore Colour Temp. [K]	IRC CRI	⁰¹ Flusso lum. Lum. flux [lm]	Efficienza lum. Lum. effic. [lm / W]	Dimensioni/Dimensions [mm]			Cod. /Code LED	Cod./Code LED DALI
					A	B	C		
↑13 ↓13	-	3000	↑1443 ↓1118	-	100	600	100	381100077	381100078
↑13 ↓13	-	4000	↑1573 ↓1209	-	100	600	100	381100079	381100080
↑13 ↓13	3	3000	↑1443 ↓1118	340	100	600	100	381100081	381100082
↑13 ↓13	3	4000	↑1573 ↓1209	360	100	600	100	381100083	381100084
↑20 ↓20	-	3000	↑2220 ↓1720	-	100	900	100	381100085	381100086
↑20 ↓20	-	4000	↑2420 ↓1860	-	100	900	100	381100087	381100088
↑20 ↓20	3	3000	↑2220 ↓1720	340	100	900	100	381100089	381100090
↑20 ↓20	3	4000	↑2420 ↓1860	360	100	900	100	381100091	381100092
↑26 ↓26	-	3000	↑2886 ↓2236	-	100	1200	100	381100093	381100094
↑26 ↓26	-	4000	↑3146 ↓2418	-	100	1200	100	381100095	381100096
↑26 ↓26	3	3000	↑2886 ↓2236	340	100	1200	100	381100097	381100098
↑26 ↓26	3	4000	↑3146 ↓2418	360	100	1200	100	381100099	381100100

↑ Luce indiretta/Indirect light

↓ Luce diretta/Direct light

■ Luce notturna/Night light

I) Versioni standard in accensione singola/ Standard Versions with single ignition

II) Il flusso effettivo potrebbe avere una tolleranza del ±10%. / The effective flux could have a tolerance of ±10%.

Venus

IP40

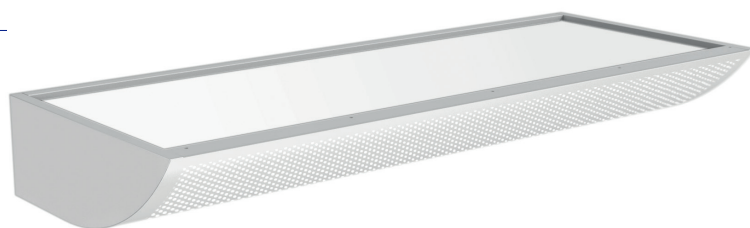

Caratteristiche tecniche

Technical Characteristics

Corpo	<ul style="list-style-type: none"> · Lamiera di acciaio · Lato inferiore in lamiera di acciaio microforata provvista di pellicola interna in policarbonato opale 	Body	<ul style="list-style-type: none"> · Sheet-steel · Lower side in micro-perforated steel-sheet with opal polycarbonate inner film
Colore	<ul style="list-style-type: none"> ○ Bianco Dry <u>Su richiesta:</u> ● Altri colori 	Colour	<ul style="list-style-type: none"> ○ Dry white <u>On request:</u> ● Other colours available
Gruppo ottico	<ul style="list-style-type: none"> · MOT - metacrilato opale 	Optical group	<ul style="list-style-type: none"> · MOT - opal methacrylate
Cablaggio	<ul style="list-style-type: none"> · LED ON/OFF con driver integrato · LED DALI con driver integrato <u>Su richiesta:</u> · Kit di EMERGENZA (autonomia 1/3 h) 	Wiring	<ul style="list-style-type: none"> · LED ON/OFF with integrated driver · LED DALI with integrated driver <u>On request:</u> · EMERGENCY kit (1/3 h autonomy)
Grado di protezione	<ul style="list-style-type: none"> · IP 40 	Protection degree	<ul style="list-style-type: none"> · IP 40

Sorgenti LED

LED sources

IRC	<ul style="list-style-type: none"> · >80 <u>Su richiesta:</u> · >90 	CRI	<ul style="list-style-type: none"> · >80 <u>On request:</u> · >90
Temp. colore	<ul style="list-style-type: none"> · 3000 K · 4000 K <u>Su richiesta:</u> · TUNABLE WHITE 2700-6500 K 	Colour Temp.	<ul style="list-style-type: none"> · 3000 K · 4000 K <u>On request:</u> · TUNABLE WHITE 2700-6500 K

Ottiche

Diffusers

MOT

Diffusore in metacrilato opale ad alta trasmittanza, ideale per una distribuzione uniforme.

Diffuser in opal methacrylate with high transmittance, ideal for uniform distribution.

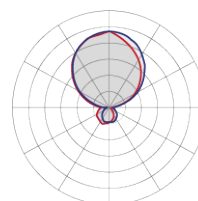

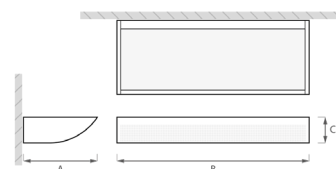
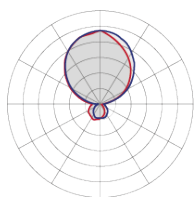

MOT



Potenza Power [W]	Temp. colore Colour Temp. [K]	IRC CRI	Flusso lum. Lum. flux [lm]	Efficienza lum. Lum. effic. [lm / W]	Dimensioni/Dimensions [mm]			Cod. / Code LED	Cod. / Code LED DALI
					A	B	C		
13	3000	>80	↑1127 ↓272	107	230	610	81	389100048	389100054
13	4000	>80	↑1212 ↓293	115	230	610	81	389100060	389100066
24	3000	>80	↑2080 ↓503	107	230	610	81	389100051	389100057
24	4000	>80	↑2240 ↓542	115	230	610	81	389100063	389100069
26	3000	>80	↑2407 ↓583	107	230	1210	81	389100049	389100055
26	4000	>80	↑4135 ↓1001	115	230	1210	81	389100061	389100067
48	3000	>80	↑4444 ↓1076	107	230	1210	81	389100052	389100058
48	4000	>80	↑2843 ↓688	115	230	1210	81	389100064	389100070
33	3000	>80	↑3055 ↓740	107	230	1510	81	389100050	389100056
33	4000	>80	↑5169 ↓2626	115	230	1510	81	389100062	389100068
60	3000	>80	↑5553 ↓1251	107	230	1510	81	389100053	389100059
60	4000	>80	↑5555 ↓1345	115	230	1510	81	389100065	389100071



↑ Luce indiretta/Indirect light

↓ Luce diretta/Direct light

1) Il flusso effettivo potrebbe avere una tolleranza del ±10%. / The effective flux could have a tolerance of ±10%.

Jelly

IP40



Caratteristiche tecniche

Technical Characteristics

Corpo	Lamiera di acciaio	Body	Sheet-steel
Colore	<ul style="list-style-type: none"> ○ Bianco opaco (RAL 9003) <u>Su richiesta:</u> ● Altri colori 	Colour	<ul style="list-style-type: none"> ○ Matt white (RAL 9003) <u>On request:</u> ● Other colours available
Gruppo ottico	· POL - policarbonato opale	Optical group	· POL - opal polycarbonate
Cablaggio	<ul style="list-style-type: none"> · LED ON/OFF con driver integrato · LED DALI con driver integrato <u>Su richiesta:</u> · Kit di EMERGENZA (autonomia 1/3 h) 	Wiring	<ul style="list-style-type: none"> · LED ON/OFF with integrated driver · LED DALI with integrated driver <u>On request:</u> · EMERGENCY kit (1/3 h autonomy)
Grado di protezione	· IP 40	Protection degree	· IP 40

Sorgenti LED

LED sources

IRC	<ul style="list-style-type: none"> · >80 <u>Su richiesta:</u> · >90 	CRI	<ul style="list-style-type: none"> · >80 <u>On request:</u> · >90
Temp. colore	<ul style="list-style-type: none"> · 3000 K · 4000 K 	Colour Temp.	<ul style="list-style-type: none"> · 3000 K · 4000 K

Ottiche

Diffusers

POL

Diffusore in policarbonato opale a finitura liscia, ideale per una distribuzione uniforme.
Diffuser in opal polycarbonate with smooth finish, ideal for uniform distribution.

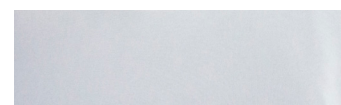
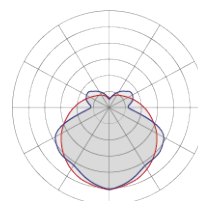

POL

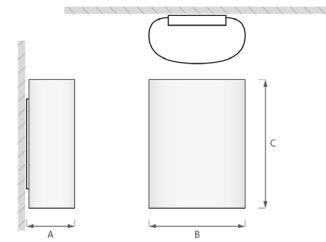
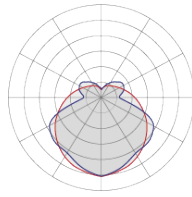

Potenza Power [W]	Temp. colore Colour Temp. [K]	IRC CRI	Flusso lum. Lum. flux [lm]	Efficienza lum. Lum. effic. [lm / W]	Dimensioni/Dimensions [mm]			Cod. / Code LED	Cod. / Code LED DALI
					A	B	C		
13	3000	>80	1209	93	150	300	400	381200019	381200020
13	4000	>80	1300	100	150	300	400	381200023	381200024
24	3000	>80	2232	93	150	300	400	381200021	381200022
24	4000	>80	2400	100	150	300	400	381200025	381200026



1) Il flusso effettivo potrebbe avere una tolleranza del ±10%. / The effective flux could have a tolerance of ±10%.

Tondo/Quadro

IP54



Tondo L



Quadro L



Caratteristiche tecniche

Technical Characteristics

Corpo	· Piastra di fissaggio in acciaio	Body	· Sheet-steel fixing plate
Colore	○ Bianco	Colour	○ White
Gruppo ottico	· CPT - Policarbonato traslucido	Optical group	· CPT - Translucent polycarbonate
Cablaggio	<ul style="list-style-type: none"> · LED ON/OFF con driver integrato · LED DALI con driver integrato · LED + SN con sensore di presenza e driver integrato Su richiesta: <ul style="list-style-type: none"> · Kit di EMERGENZA (autonomia 1/3 h) 	Wiring	<ul style="list-style-type: none"> · LED ON/OFF with integrated driver · LED DALI with integrated driver · LED + SN with integrated sensor and driver On request: <ul style="list-style-type: none"> · EMERGENCY kit (1/3 h autonomy)
Grado di protezione	· IP 54	Protection degree	· IP 54

Sorgenti LED

LED sources

IRC	>80	CRI	>80
Temp. colore	<ul style="list-style-type: none"> · 3000 K · 4000 K 	Colour Temp.	<ul style="list-style-type: none"> · 3000 K · 4000 K

Ottiche Diffusers

CPT

Diffusore in policarbonato traslucido, stabilizzato ai raggi UV, ad altissima resistenza meccanica. Glow-wire test a 850°C secondo le norme CEI EN 60695-2-11.

Translucent polycarbonate diffuser, UV stabilized with high mechanical resistance. Glow-wire test 850°C according to the CEI EN 60695-2-11 directives.

Tondo L

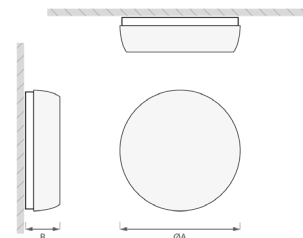
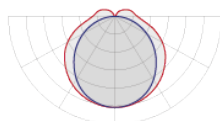

CPT



Potenza Power [W]	Temp. colore Colour Temp. [K]	IRC CRI	Flusso lum. Lum. flux [lm]	Efficienza lum. Lum. effic. [lm / W]	Dimensioni/Dimensions [mm]		Cod./ Code LED	Cod./ Code LED DALI	Cod./ Code LED + SN
					A (Ø)	B			
10	3000	>80	1159	115	300	85	363500027	-	363500035
10	4000	>80	1220	122	300	85	363500001	-	363500005
12	3000	>80	1425	118	300	85	363500057	363500065	363500089
12	4000	>80	1500	125	300	85	363500061	363500069	363500093
14	3000	>80	1653	118	300	85	363500058	363500066	363500090
14	4000	>80	1740	124	300	85	363500062	363500070	363500094
16	3000	>80	1881	117	300	85	363500059	363500067	363500091
16	4000	>80	1980	123	300	85	363500063	363500071	363500095
24	3000	>80	2698	112	300	85	363500060	363500068	363500092
24	4000	>80	2840	118	300	85	363500064	363500072	363500096

Quadro L

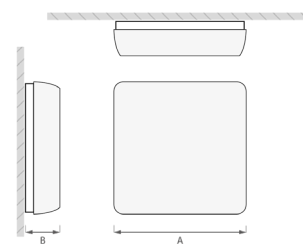
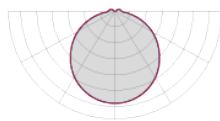

CPT



Potenza Power [W]	Temp. colore Colour Temp. [K]	IRC CRI	Flusso lum. Lum. flux [lm]	Efficienza lum. Lum. effic. [lm / W]	Dimensioni/Dimensions [mm]		Cod./ Code LED	Cod./ Code LED DALI	Cod./ Code LED + SN
					A	B			
10	3000	>80	1178	117	330	85	381700025	-	381700039
10	4000	>80	1240	124	330	85	381700001	-	381700040
12	3000	>80	1444	120	330	85	381700059	381700067	381700091
12	4000	>80	1520	126	330	85	381700055	381700063	381700087
14	3000	>80	1672	119	330	85	381700060	381700068	381700092
14	4000	>80	1760	125	330	85	381700056	381700064	381700088
16	3000	>80	1900	118	330	85	381700061	381700069	381700093
16	4000	>80	2000	125	330	85	381700057	381700065	381700089
24	3000	>80	2736	114	330	85	381700062	381700070	381700094
24	4000	>80	2880	120	330	85	381700058	381700066	381700090



Pill

IP65



Pill



Pill R



Caratteristiche tecniche

Technical Characteristics

Corpo · Policarbonato stabilizzato ai raggi UV

Body · UV raiis stabilized polycarbonate

Colore ○ Bianco

Colour ○ White

Gruppo ottico · POT- Policarbonato opale

Optical group · POT - Opal polycarbonate

Cablaggio · LED ON/OFF con driver integrato

Wiring · LED ON/OFF with integrated driver

Grado di protezione · IP 65

Protection degree · IP 65

Sorgenti LED

LED sources

IRC >80

CRI >80

Temp. colore · 4000 K

Colour Temp. · 4000 K

Ottiche Diffusers

POT

Diffusore in policarbonato opale ad alta trasmittanza. Glow-wire test a 850°C secondo le norme CEI EN 60695-2-11.

Opal polycarbonate diffuser with high transmittance. Glow-wire test 850°C according to the CEI EN 60695-2-11 directives.

Pill

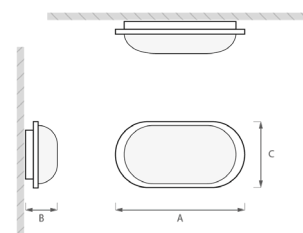
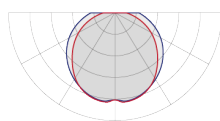

CPT



Potenza Power [W]	Temp. colore Colour Temp. [K]	IRC CRI	Flusso lum. Lum. flux [lm]	Efficienza lum. Lum. effic. [lm / W]	Dimensioni/Dimensions [mm]			Cod./ Code LED
					A	B	C	
15	4000	>80	1580	105	215	62	115	363700001
20	4000	>80	2100	105	271	76	146	363700002

Pill R

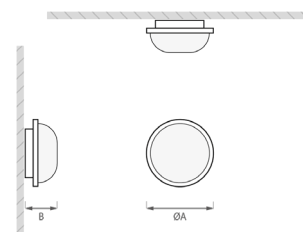
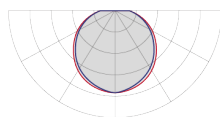

CPT



Potenza Power [W]	Temp. colore Colour Temp. [K]	IRC CRI	Flusso lum. Lum. flux [lm]	Efficienza lum. Lum. effic. [lm / W]	Dimensioni/Dimensions [mm]		Cod./ Code LED
					Ø A	B	
15	4000	>80	1470	98	167	62	363600001
20	4000	>80	1960	98	221	72	363600002



Courtesy

IP66



Caratteristiche tecniche

Technical Characteristics

Corpo	Alluminio pressofuso idoneo per scatole porta frutto rettangolari (503)	Body	Diecast aluminium suitable for rectangular flush mounting boxes (503)
Colore	○ Bianco	Colour	○ White
Gruppo ottico	· VTR - vetro temprato trasparente, fascio di emissione 38°	Optical group	· VTR - transparent tempered glass, 38° beam angle
Cablaggio	· LED ON/OFF con driver integrato	Wiring	· LED ON/OFF with integrated driver
Grado di protezione	· IP 66	Protection degree	· IP 66

Sorgenti LED

LED sources

IRC	· >80	CRI	· >80
Temp. colore	· 3000/4000/6000 K - settabile	Colour Temp.	· 3000/4000/6000 K - switchable

Ottiche

Diffusers

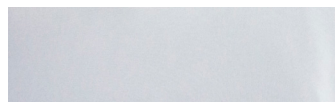

VTR

Diffusore in vetro temprato trasparente, angolo di emissione 38°.
Diffuser in transparent tempered glass, 38° beam angle.

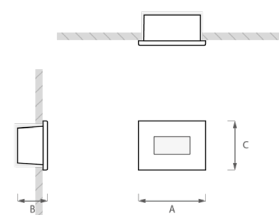
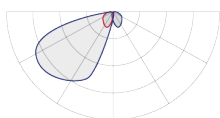

VTR



Potenza Power [W]	Temp. colore Colour Temp. [K]	IRC CRI	Flusso lum. Lum. flux [lm]	Efficienza lum. Lum. effic. [lm / W]	Dimensioni/Dimensions [mm]				Cod./ Code LED
					A	B	C		
3	 3000 4000 6000	>80	200	66	115	81	50	87,5x53x55	900000638



1) Il flusso effettivo potrebbe avere una tolleranza del ±10%. / The effective flux could have a tolerance of ±10%.

Way UP

IP40

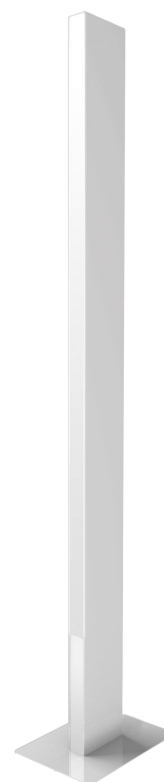

Caratteristiche tecniche

Technical Characteristics

Corpo	Profilo estruso in alluminio	Body	Extruded aluminium profile
Colore	<input type="radio"/> Bianco Dry <input checked="" type="radio"/> Nero Dry <u>Su richiesta:</u> <input type="radio"/> Metallizzati <input type="radio"/> Altri colori	Colour	<input type="radio"/> Dry white <input checked="" type="radio"/> Dry black <u>On request:</u> <input type="radio"/> Metallic <input type="radio"/> Other colours available
Gruppo ottico	· PST - policarbonato opale satinato	Optical group	· PST - glazed opal polycarbonate
Cablaggio	· LED ON/OFF <u>Su richiesta:</u> · Circuito RGB · Kit di EMERGENZA (autonomia 1/3 h)	Wiring	· LED ON/OFF <u>On request:</u> · RGB circuit · EMERGENCY kit (1/3 h autonomy)
Grado di protezione	IP 40	Protection degree	IP 40

Sorgenti LED

LED sources

IRC	· >80 <u>Su richiesta:</u> · >90	CRI	· >80 <u>On request:</u> · >90
Temp. colore	· 3000 K · 4000 K <u>Su richiesta:</u> · TUNABLE WHITE 2700-6500 K · LED RGB	Colour Temp.	· 3000 K · 4000 K <u>On request:</u> · TUNABLE WHITE 2700-6500 K · RGB LED

Ottiche

Diffusers

PST

Diffusore in policarbonato opale satinato a finitura liscia, ideale per una distribuzione uniforme.

Diffuser in glazed opal polycarbonate with smooth finish, ideal for uniform distribution.

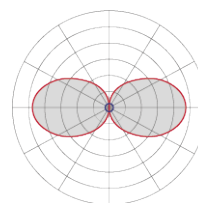

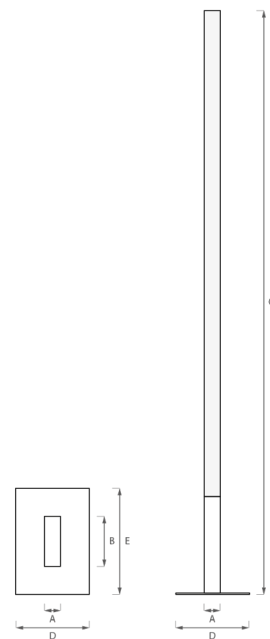
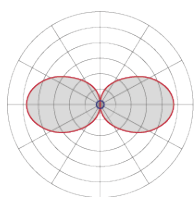

PST

Potenza Power [W]	Temp. colore Colour Temp. [K]	IRC CRI	Flusso lum. Lum. flux [lm]	Efficienza lum. Lum. effic. [lm / W]	Dimensioni/Dimensions [mm]					Cod. / Code LED
					A	B	C	D	E	
○ Bianco Dry/Dry white										
66	3000	>80	5610	85	50	156	1818	230	330	667000013
66	4000	>80	6006	91	50	156	1818	230	330	667000014
● Nero Dry/Dry black										
66	3000	>80	5610	85	50	156	1818	230	330	667000020
66	4000	>80	6006	91	50	156	1818	230	330	667000022



1) Il flusso effettivo potrebbe avere una tolleranza del ±10%. / The effective flux could have a tolerance of ±10%.

Way UP++

IP40



Caratteristiche tecniche

Technical Characteristics

Corpo	Profilo estruso in alluminio	Body	Extruded aluminium profile
Colore	<input type="radio"/> Bianco Dry <input checked="" type="radio"/> Nero Dry <u>Su richiesta:</u> <input type="radio"/> Metallizzati <input type="radio"/> Altri colori	Colour	<input type="radio"/> Dry white <input checked="" type="radio"/> Dry black <u>On request:</u> <input type="radio"/> Metallic <input type="radio"/> Other colours available
Gruppo ottico	· PST - policarbonato opale satinato	Optical group	· PST - glazed opal polycarbonate
Cablaggio	· LED ON/OFF <u>Su richiesta:</u> · Circuito RGB · Kit di EMERGENZA (autonomia 1/3 h)	Wiring	· LED ON/OFF <u>On request:</u> · RGB circuit · EMERGENCY kit (1/3 h autonomy)
Grado di protezione	IP 40	Protection degree	IP 40

Sorgenti LED

LED sources

IRC	· >80 <u>Su richiesta:</u> · >90	CRI	· >80 <u>On request:</u> · >90
Temp. colore	· 3000 K · 4000 K <u>Su richiesta:</u> · TUNABLE WHITE 2700-6500 K · LED RGB	Colour Temp.	· 3000 K · 4000 K <u>On request:</u> · TUNABLE WHITE 2700-6500 K · RGB LED

Ottiche

Diffusers

PST

Diffusore in policarbonato opale satinato a finitura liscia, ideale per una distribuzione uniforme.

Diffuser in glazed opal polycarbonate with smooth finish, ideal for uniform distribution.

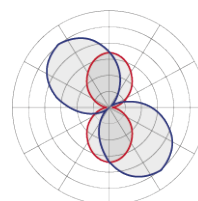

PST

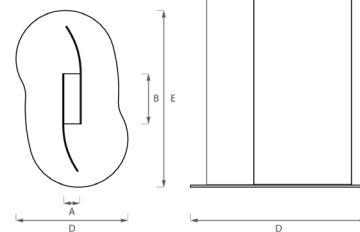
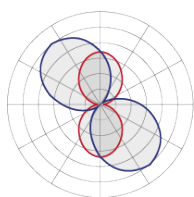

Potenza Power [W]	Temp. colore Colour Temp. [K]	IRC CRI	Flusso lum. Lum. flux [lm]	Efficienza lum. Lum. effic. [lm / W]	Dimensioni/Dimensions [mm]					Cod. / Code LED
					A	B	C	D	E	
○ Bianco Dry/Dry white										
66	3000	>80	5610	85	50	156	1818	350	550	668000006
66	4000	>80	6006	91	50	156	1818	350	550	668000007
● Nero Dry/Dry black										
66	3000	>80	5610	85	50	156	1818	350	550	668000012
66	4000	>80	6006	91	50	156	1818	350	550	668000014



1) Il flusso effettivo potrebbe avere una tolleranza del ±10%. / The effective flux could have a tolerance of ±10%.



INDU- STRIALE *INDUSTRIAL*

Superlite

Sistema di illuminazione per **fila continua a LED** con cinque ottiche a lenti ideali per diversi tipi di applicazione. Grazie ad una gamma completa di accessori, è un **sistema flessibile e configurabile** adatto in particolare al settore **industriale e retail**.

*Continuous LED lighting system with five lens optics suitable for different types of applications. Thanks to a complete range of accessories, it is a **flexible and configurable system** particularly indicated for **industrial and retail sector**.*

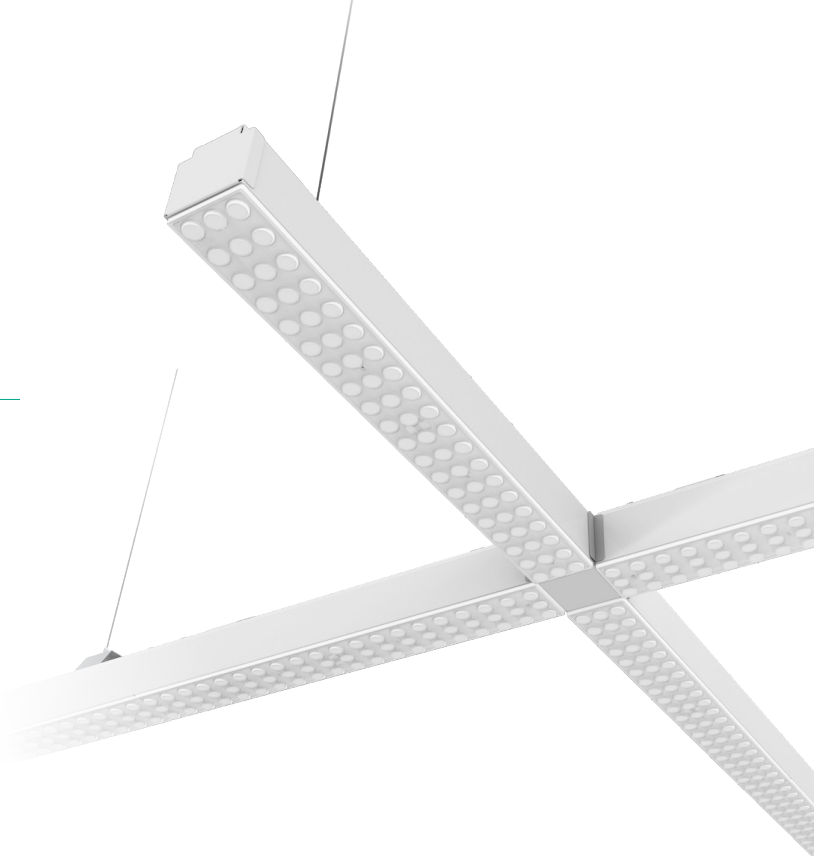

Caratteristiche tecniche

Technical Characteristics

Corpo	Lamiera di acciaio	Body	Sheet-steel
Colore	○ Bianco Opaco (RAL 9003) <u>Su richiesta:</u> ● Altri colori	Colour	○ Matt white (RAL 9003) <u>On request:</u> ● Other colours available
Gruppo ottico	· PMMA - Lente in PMMA (Medium 60°, Wide 90°, Extra wide 110°, Retail Sym, High Rack)	Optical group	· PMMA - PMMA Lens (Medium 60°, Wide 90°, Extra wide 110°, Retail Sym, High Rack)
Cablaggio	· LED ON/OFF con driver integrato · LED DALI con driver integrato <u>Su richiesta:</u> · Kit di EMERGENZA (autonomia 1/3 h)	Wiring	· LED ON/OFF with integrated driver · LED DALI with integrated driver <u>On request:</u> · EMERGENCY kit (1/3 h autonomy)
Grado di protezione	· IP 40	Protection degree	· IP 40

Sorgenti LED

LED sources

IRC	· >80	CRI	· >80
Temp. colore	· 4000 K	Colour Temp.	· 4000 K

Gruppi ottici

Optical groups

PMMA

Lente in PMMA trasparente ad altissima efficienza >95%.
 Possibilità di avere vari fasci di illuminazione in base all'ambiente di installazione.
PMMA Lens highly efficient up to 95% transparent lens.
Several light distribution beams available according to installation.



Lenti / Lens

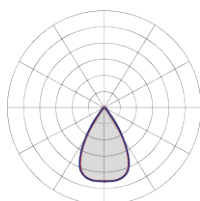

Medium
60°

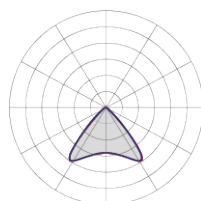

Wide
90°

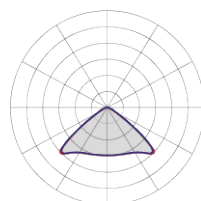

Extra Wide
110°

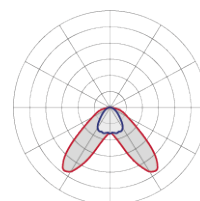

Retail Sym

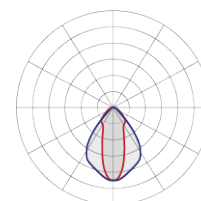

High Rack

Accessori (da ordinare separatamente)

Accessories (to be ordered separately)



2 pcs. kit

TESTATE DI CHIUSURA

END CAPS

Cod. / Code **TC645297**

Lamiera d'acciaio verniciata di colore bianco opaco (RAL 9003).

Matt white powder coated sheet-steel (RAL 9003).

Giunti / Connectors



STAFFA D'UNIONE

UNION BRACKET

Cod. / Code **KFS645221**

Per l'installazione in linea continua, in acciaio zincato. Completo di viti di fissaggio.

Galvanized steel union bracket for continuous line installation. Fixing screws included.

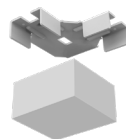

KIT DI UNIONE 2 VIE (90°)

2 WAYS UNION KIT (90°)

Cod. / Code **IN645297L**

Per l'installazione ad angolo (90°), in acciaio zincato. Completo di viti di fissaggio.

Galvanized steel corner union bracket (90°). Fixing screws included.

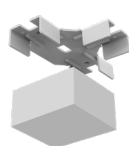

KIT DI UNIONE 3 VIE (T)

3 WAYS UNION KIT (T)

Cod. / Code **IN645297T**

Per l'installazione a T, in acciaio zincato. Completo di viti di fissaggio.

Galvanized steel T-way union bracket. Fixing screws included.



KIT DI UNIONE 4 VIE (X)

4 WAYS UNION KIT (X)

Cod. / Code **IN645297X**

Per l'installazione a X, in acciaio zincato. Completo di viti di fissaggio.

Galvanized steel X-way union bracket. Fixing screws included.

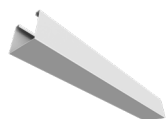

MODULO CIECO LINEARE

LINEAR INFILL MODULE

Cod. / Code **MC645297X**

Lamiera di acciaio verniciata di colore bianco opaco (RAL 9003). Staffe di unione incluse

Matt white powder coated sheet-steel (RAL 9003). Union brackets included

- **0500** : L = 500mm
- **1000** : L = 1000mm
- **1500** : L = 1500mm
- **2000** : L = 2000mm

Sospensione / Suspension



L = 2000 mm

KIT DI SOSPENSIONE

SUSPENSION KIT

Cod. / Code **KS802**

Comprensivo di molla, cavo metallico, bloccafune e viti di fissaggio.

S pring, metal cable, function locks and fixing screws included.

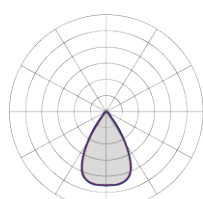

Medium
60°

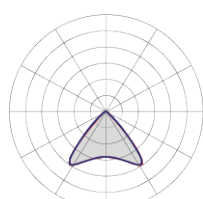

Wide
90°

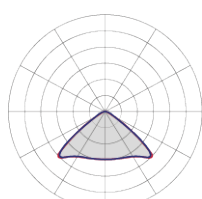

Extra Wide
110°

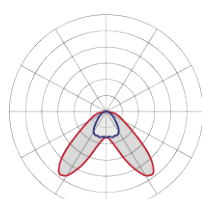

Retail Sym

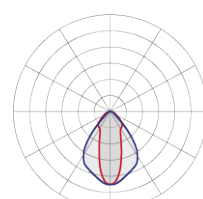

High Rack

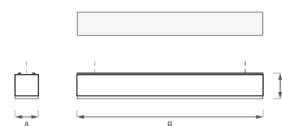

PMMA



Potenza Power [W]	Temp. colore Colour Temp. [K]	IRC CRI	Flusso lum. Lum. flux [lm]	Efficienza lum. Lum. effic. [lm / W]	Dimensioni/Dimensions [mm]			Cod. / Code LED	Cod. / Code LED DALI
					A	B	C		
Medium 60°									
22	4000	>80	3278	149	63	500	65	645200041	645200046
32	4000	>80	4513	142	63	500	65	645200001	645200006
44	4000	>80	6555	149	63	1000	65	645200051	645200056
64	4000	>80	9025	142	63	1000	65	645200011	645200016
66	4000	>80	9833	149	63	1500	65	645200061	645200066
88	4000	>80	13110	149	63	2000	65	645200071	645200076
96	4000	>80	13538	142	63	1500	65	645200021	645200026
128	4000	>80	18050	142	63	2000	65	645200031	645200036
Wide 90°									
22	4000	>80	3278	149	63	500	65	645200042	645200047
32	4000	>80	4513	142	63	500	65	645200002	645200007
44	4000	>80	6555	149	63	1000	65	645200052	645200057
64	4000	>80	9025	142	63	1000	65	645200012	645200017
66	4000	>80	9833	149	63	1500	65	645200062	645200067
88	4000	>80	13110	149	63	2000	65	645200072	645200077
96	4000	>80	13538	142	63	1500	65	645200022	645200027
128	4000	>80	18050	142	63	2000	65	645200032	645200037
Extra wide 110°									
22	4000	>80	3278	149	63	500	65	645200043	645200048
32	4000	>80	4513	142	63	500	65	645200003	645200008
44	4000	>80	6555	149	63	1000	65	645200053	645200058
64	4000	>80	9025	142	63	1000	65	645200013	645200018
66	4000	>80	9833	149	63	1500	65	645200063	645200068
88	4000	>80	13110	149	63	2000	65	645200073	645200078
96	4000	>80	13538	142	63	1500	65	645200023	645200028
128	4000	>80	18050	142	63	2000	65	645200033	645200038

Potenza Power [W]	Temp. colore Colour Temp. [K]	IRC CRI	Flusso lum. Lum. flux [lm]	Efficienza lum. Lum. effic. [lm / W]	Dimensioni/Dimensions [mm]			Cod. / Code LED	Cod. / Code LED DALI
					A	B	C		
Retail Sym									
22	4000	>80	3278	149	63	500	65	645200044	645200049
32	4000	>80	4513	142	63	500	65	645200004	645200009
44	4000	>80	6555	149	63	1000	65	645200054	645200059
64	4000	>80	9025	142	63	1000	65	645200014	645200019
66	4000	>80	9833	149	63	1500	65	645200064	645200069
88	4000	>80	13110	149	63	2000	65	645200074	645200079
96	4000	>80	13538	142	63	1500	65	645200024	645200029
128	4000	>80	18050	142	63	2000	65	645200034	645200039
High Rack									
22	4000	>80	3278	149	63	500	65	645200045	645200050
32	4000	>80	4513	142	63	500	65	645200005	645200010
44	4000	>80	6555	149	63	1000	65	645200055	645200060
64	4000	>80	9025	142	63	1000	65	645200015	645200020
66	4000	>80	9833	149	63	1500	65	645200065	645200070
88	4000	>80	13110	149	63	2000	65	645200075	645200080
96	4000	>80	13538	142	63	1500	65	645200025	645200030
128	4000	>80	18050	142	63	2000	65	645200035	645200040



Lumiforce



1X



2X

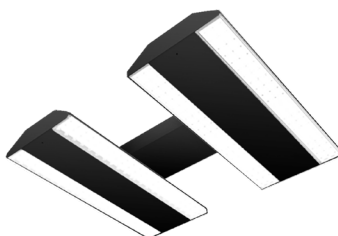

Caratteristiche tecniche

Technical Characteristics

Corpo	· Lamiera di alluminio	Body	· Aluminium sheet
Colore	○ Bianco opaco (RAL 9003) ● Nero opaco (RAL 9005)	Colour	○ Matt white (RAL 9003) ● Matt black (RAL 9005)
Gruppo ottico	· PMMA - Lente in PMMA (30°, 60°, 90°)	Optical group	· PMMA - PMMA Lens (30°, 60°, 90°)
Cablaggio	· LED-F ON/OFF con fusibile di protezione · LED-F DALI con fusibile di protezione <u>Su richiesta:</u> · Kit di EMERGENZA (autonomia 1/3 h)	Wiring	· LED-F ON/OFF with fused terminal block · LED-F DALI with fused terminal block <u>On request:</u> · EMERGENCY kit (1/3 h autonomy)
Grado di protezione	· IP 54 · IK 7	Protection degree	· IP 54 · IK 7

Sorgenti LED

LED sources

IRC	>80	CRI	>80
Temp. colore	· 4000 K	Colour Temp.	· 4000 K

Gruppi ottici

Optical groups

PMMA

Lente in PMMA trasparente ad altissima efficienza >95%, stabilizzato ai raggi UV. Possibilità di avere vari fasci di illuminazione in base all'ambiente di installazione.
PMMA Lens highly efficient up to 95% transparent lens, UV rays stabilized.
Several light distribution beams available according to installation.



Lenti / Lens

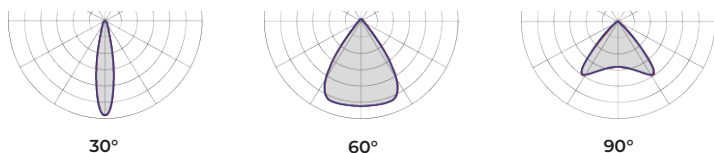

Accessori (da ordinare separatamente)
Accessories (to be ordered separately)

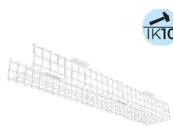

GABBIA PROTETTIVA
PROTECTIVE GRID

Cod. / Code GBP4640x

Protezione metallica.

Per la versione LUMIFORCE 2X è necessario ordinare 2pz.
 Metal protection.

It is necessary to order 2 pcs. for LUMIFORCE 2X version.

• **97** : colore bianco / white colour

• **30** : colore nero / black colour

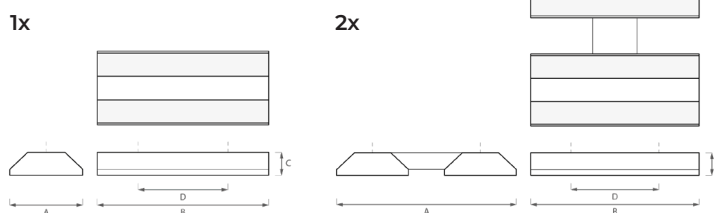

PMMA



	Potenza Power [W]	Lente Lens	Temp. colore Colour Temp. [K]	IRC CRI	Flusso lum. Lum. flux [lm]	Efficienza lum. Lum. effic. [lm / W]	Dimensioni / Dimensions [mm]				Cod. / Code LED-F	Cod. / Code LED-F DALI
							A	B	C	D		
○ RAL 9003												
1x	64	30°	4000	>80	11264	176	256	600	80	400	464000060	464000061
1x	64	60°	4000	>80	11264	176	256	600	80	400	464000062	464000063
1x	64	90°	4000	>80	11264	176	256	600	80	400	464000064	464000065
1x	96	30°	4000	>80	15840	165	256	600	80	400	464000066	464000067
1x	96	60°	4000	>80	15840	165	256	600	80	400	464000068	464000069
1x	96	90°	4000	>80	15840	165	256	600	80	400	464000070	464000071
2x	64+64	30°	4000	>80	22528	176	640	600	80	400	464000087	464000088
2x	64+64	60°	4000	>80	22528	176	640	600	80	400	464000089	464000090
2x	64+64	90°	4000	>80	22528	176	640	600	80	400	464000091	464000092
2x	96+96	30°	4000	>80	31680	165	640	600	80	400	464000093	464000094
2x	96+96	60°	4000	>80	31680	165	640	600	80	400	464000095	464000096
2x	96+96	90°	4000	>80	31680	165	640	600	80	400	464000097	464000098
● RAL 9005												
1x	64	30°	4000	>80	11264	176	256	600	80	400	464000075	464000076
1x	64	60°	4000	>80	11264	176	256	600	80	400	464000077	464000078
1x	64	90°	4000	>80	11264	176	256	600	80	400	464000079	464000080
1x	96	30°	4000	>80	15840	165	256	600	80	400	464000081	464000082
1x	96	60°	4000	>80	15840	165	256	600	80	400	464000083	464000084
1x	96	90°	4000	>80	15840	165	256	600	80	400	464000085	464000086
2x	64+64	30°	4000	>80	22528	176	640	600	80	400	464000099	464000100
2x	64+64	60°	4000	>80	22528	176	640	600	80	400	464000101	464000102
2x	64+64	90°	4000	>80	22528	176	640	600	80	400	464000103	464000104
2x	96+96	30°	4000	>80	31680	165	640	600	80	400	464000105	464000106
2x	96+96	60°	4000	>80	31680	165	640	600	80	400	464000107	464000108
2x	96+96	90°	4000	>80	31680	165	640	600	80	400	464000109	464000110

1) Il flusso effettivo potrebbe avere una tolleranza del ±10%. / The effective flux could have a tolerance of ±10%

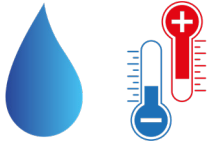

Mach

Industriale | Industrial

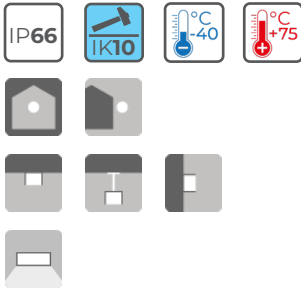

Mach

Mach Extreme

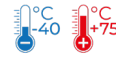

Caratteristiche tecniche

Technical Characteristics

<p>Corpo</p> <ul style="list-style-type: none"> · Profilo estruso in alluminio · Testate di chiusura in alluminio <p>Colore</p> <ul style="list-style-type: none"> ● Grigio (trattamento anti-corrosione) <p>Gruppo ottico</p> <ul style="list-style-type: none"> · VSB - vetro temprato sabbiato <p>Cablaggio</p> <ul style="list-style-type: none"> · LED ON/OFF con driver integrato · LED DALI con driver integrato <p><u>Su richiesta:</u></p> <ul style="list-style-type: none"> · Kit di EMERGENZA (autonomia 1/3 h) <p>Grado di protezione</p> <ul style="list-style-type: none"> · IP 66 · IK 10 	<p>Body</p> <ul style="list-style-type: none"> · Extruded aluminium profile · Aluminium end caps <p>Colour</p> <ul style="list-style-type: none"> ● Grey (anti-corrosion treatment) <p>Optical group</p> <ul style="list-style-type: none"> · VSB - sandblast tempered glass <p>Wiring</p> <ul style="list-style-type: none"> · LED ON/OFF with integrated driver · LED DALI with integrated driver <p><u>On request:</u></p> <ul style="list-style-type: none"> · EMERGENCY kit (1/3 h autonomy) <p>Protection degree</p> <ul style="list-style-type: none"> · IP 66 · IK 10
---	---

Sorgenti LED

LED sources

<p>IRC</p> <ul style="list-style-type: none"> · >80 <p><u>Su richiesta:</u></p> <ul style="list-style-type: none"> · >90 <p>Temp. colore</p> <ul style="list-style-type: none"> · 4000 K 	<p>CRI</p> <ul style="list-style-type: none"> · >80 <p><u>On request:</u></p> <ul style="list-style-type: none"> · >90 <p>Colour Temp.</p> <ul style="list-style-type: none"> · 4000 K
---	---

Ottiche

Diffusers

VSB

Diffusore in vetro temprato con finitura sabbiata.
Resistente agli shock termici e agli urti.
*Diffuser made of tempered glass with sandblast finishing.
Shocks and impacts resistant.*

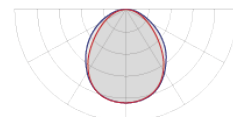

Accessori (da ordinare separatamente)
Accessories (to be ordered separately)

Parete / Wall



STAFFA DI FISSAGGIO REGOLABILE
ADJUSTABLE WALL BRACKET

Cod. / Code KPR459023

Lamiera di acciaio zincato, verniciata bianco.
 Completo di viti di fissaggio.

Galvanized steel sheet, white powder coated.
Fixing screws included.

2 pcs. kit

VSB

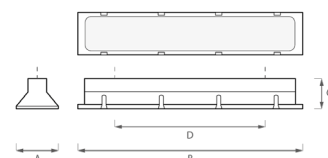
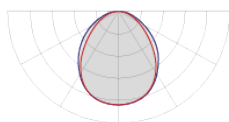

Mach



Potenza Power [W]	Temp. colore Colour Temp. [K]	IRC CRI	Flusso lum. Lum. flux [lm]	Efficienza lum. Lum. effic. [lm / W]	Dimensioni / Dimensions [mm]				Cod. / Code LED	Cod. / Code LED DALI
					A	B	C	D		
8	4000	>80	1000	125	105	624	75	534	459000222	459000223
10	4000	>80	1200	120	105	624	75	534	459000092	459000108
14	4000	>80	1670	119	105	624	75	534	459000226	459000227
16	4000	>80	1960	122	105	1224	75	1134	459000230	459000231
20	4000	>80	2360	118	105	1224	75	1134	459000234	459000235
27	4000	>80	3310	122	105	1224	75	1134	459000238	459000239
20	4000	>80	2460	123	105	1524	75	1434	459000242	459000243
24	4000	>80	2950	122	105	1524	75	1434	459000246	459000247
33	4000	>80	4120	124	105	1524	75	1434	459000250	459000251
16	4000	>80	1970	123	105	624	75	534	459000254	459000255
19	4000	>80	2330	122	105	624	75	534	459000257	459000258
27	4000	>80	3290	121	105	624	75	534	459000260	459000261
31	4000	>80	3860	124	105	1224	75	1134	459000263	459000264
37	4000	>80	4700	127	105	1224	75	1134	459000266	459000267
51	4000	>80	6530	128	105	1224	75	1134	459000269	459000270
38	4000	>80	4790	126	105	1524	75	1434	459000274	459000275
46	4000	>80	5810	126	105	1524	75	1434	459000278	459000279
71	4000	>80	9040	127	105	1524	75	1434	459000080	459000205

Mach Extreme



Potenza Power [W]	Temp. eserc. Operat. Temp. [°C]	Temp. colore Colour Temp. [K]	IRC CRI	Flusso lum. Lum. flux [lm]	Efficienza lum. Lum. effic. [lm / W]	Dimensioni / Dimensions [mm]				Cod. / Code LED	Cod. / Code LED DALI
						A	B	C	D		
24	-40 +75	4000	>80	3050	127	105	1524	75	1434	459000210	459000216
33	-40 +70	4000	>80	4120	124	105	1524	75	1434	459000211	459000217
37	-40 +70	4000	>80	4700	127	105	1224	75	1134	459000284	459000288
51	-40 +65	4000	>80	6530	128	105	1224	75	1134	459000285	459000289
46	-40 +70	4000	>80	5810	126	105	1524	75	1434	459000286	459000290
71	-40 +65	4000	>80	9040	127	105	1524	75	1434	459000287	459000291

1) Il flusso effettivo potrebbe avere una tolleranza del ±10%. / The effective flux could have a tolerance of ±10%.



Tekno

Industriale | Industrial



Caratteristiche tecniche

Technical Characteristics

Corpo	· Acciaio stampato monoblocco (INOX AISI 304)	Body	· Injection-moulded stainless steel (AISI 304 INOX)
Colore	● INOX AISI 304	Colour	● INOX AISI 304
Gruppo ottico	· VSB - vetro temprato sabbiato	Optical group	· VSB - sandblast tempered glass
Cablaggio	· LED ON/OFF con driver integrato · LED DALI con driver integrato <u>Su richiesta:</u> · Kit di EMERGENZA (autonomia 1/3 h)	Wiring	· LED ON/OFF with integrated driver · LED DALI with integrated driver <u>On request:</u> · EMERGENCY kit (1/3 h autonomy)
Grado di protezione	· IP 65 · IK 10	Protection degree	· IP 65 · IK 10

Sorgenti LED

LED sources

IRC	· >80 <u>Su richiesta:</u> · >90	CRI	· >80 <u>On request:</u> · >90
Temp. colore	· 4000 K	Colour Temp.	· 4000 K

Ottiche Diffusers

VSB

Riflettore interno in lamiera di acciaio, verniciato di colore bianco. Diffusore in vetro temprato con finitura sabbata VSB, resistente agli shock termici e agli urti. Guarnizione interne di tenuta (IP66).

Sheet-steel internal reflector white powder coated. Diffuser made of tempered glass with sandblast finishing. Shocks and impacts resistant.

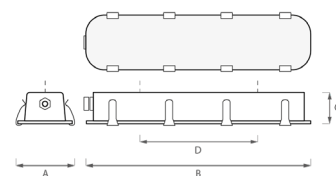
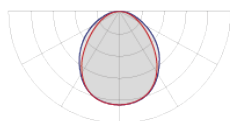
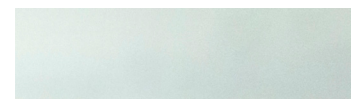
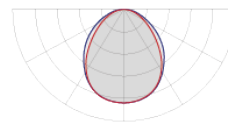

VSB



Potenza Power [W]	Temp. colore Colour Temp. [K]	IRC CRI	Flusso lum. Lum. flux [lm]	Efficienza lum. Lum. effic. [lm / W]	Dimensioni / Dimensions [mm]				Cod. / Code LED	Cod. / Code LED DALI
					A	B	C	D		
9	4000	>80	1040	115	120	680	67	360	458100105	458100106
11	4000	>80	1280	116	120	680	67	360	458100107	458100108
15	4000	>80	1760	117	120	680	67	360	458100070	458100071
18	4000	>80	2090	116	120	1290	67	850	458100072	458100073
22	4000	>80	2580	117	120	1290	67	850	458100074	458100075
30	4000	>80	3540	118	120	1290	67	850	458100076	458100077
43	4000	>80	5100	118	120	1290	67	850	458100078	458100079
22	4000	>80	2540	115	120	1600	67	1050	458100080	458100081
27	4000	>80	3190	118	120	1600	67	1050	458100082	458100083
37	4000	>80	4460	120	120	1600	67	1050	458100084	458100085
54	4000	>80	6410	118	120	1600	67	1050	458100086	458100087

1) Il flusso effettivo potrebbe avere una tolleranza del ±10%. / The effective flux could have a tolerance of ±10%.



Igloo

Industriale | Industrial

IP66

IK10



Caratteristiche tecniche

Technical Characteristics

Corpo	<ul style="list-style-type: none"> · Policarbonato stabilizzato ai raggi UV, autoestinguente V2 · Clips di chiusura in fibra di vetro e poliammide 	Body	<ul style="list-style-type: none"> · V2 self-extinguishing injection-moulded polycarbonate, UV rays stabilized · Fiberglass and polyamide sealing brackets
Colore	● Grigio (RAL 7035)	Colour	● Grey (RAL 7035)
Gruppo ottico	· CPT - policarbonato traslucido	Optical group	· CPT - translucent polycarbonate
Cablaggio	<ul style="list-style-type: none"> · LED ON/OFF con driver integrato · LED DALI con driver integrato <p><u>Su richiesta:</u></p> <ul style="list-style-type: none"> · Kit di EMERGENZA (autonomia 1/3 h) 	Wiring	<ul style="list-style-type: none"> · LED ON/OFF with integrated driver · LED DALI with integrated driver <p><u>On request:</u></p> <ul style="list-style-type: none"> · EMERGENCY kit (1/3 h autonomy)
Grado di protezione	<ul style="list-style-type: none"> · IP 66 · IK 10 	Protection degree	<ul style="list-style-type: none"> · IP 66 · IK 10

Sorgenti LED

LED sources

IRC	<ul style="list-style-type: none"> · >80 <p><u>Su richiesta:</u></p> <ul style="list-style-type: none"> · >90 	CRI	<ul style="list-style-type: none"> · >80 <p><u>On request:</u></p> <ul style="list-style-type: none"> · >90
Temp. colore	· 4000 K	Colour Temp.	· 4000 K

Ottiche

Diffusers

CPT

Diffusore in policarbonato traslucido, stabilizzato ai raggi UV, ad altissima resistenza meccanica.

Translucent polycarbonate diffuser, UV stabilized with high mechanical resistance.

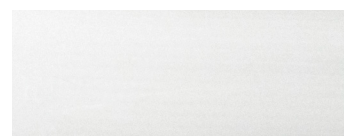
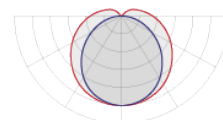

Accessori (da ordinare separatamente)
Accessories (to be ordered separately)

Parete / Wall

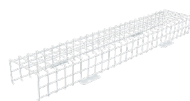

GABBIA PROTETTIVA
PROTECTIVE GRID

Cod. / Code GBP461001000X

Protezione metallica di colore bianco.

White metal protection

- **1** : 700 x 200 x 130 mm
- **2** : 1300 x 220 x 130 mm
- **3** : 1600 x 220 x 130 mm



2 pcs. kit

STAFFA DI FISSAGGIO REGOLABILE
ADJUSTABLE WALL BRACKET

Cod. / Code KPR459023

Lamiera di acciaio zincato, verniciata bianco.
 Completo di viti di fissaggio.

Galvanized steel sheet, white powder coated.
 Fixing screws included.

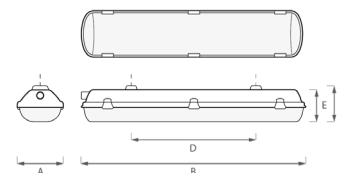
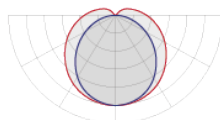

CPT



Potenza Power [W]	Temp. colore Colour Temp. [K]	IRC CRI	Flusso lum. Lum. flux [lm]	Efficienza lum. Lum. effic. [lm / W]	Dimensioni / Dimensions [mm]					Cod. / Code LED	Cod. / Code LED DALI
					A	B	C	D	E		
8	4000	>80	1170	146	95	662	111	350	100	461000234	461000567
10	4000	>80	1410	141	95	662	111	350	100	461000341	461000289
14	4000	>80	1960	140	95	662	111	350	100	461000290	461000568
16	4000	>80	2300	143	95	1272	111	700	100	461000374	461000570
20	4000	>80	2770	138	95	1272	111	700	100	461000300	461000574
27	4000	>80	3870	143	95	1272	111	700	100	461000252	461000578
38	4000	>80	5570	146	95	1272	111	700	100	461000466	461000582
20	4000	>80	2880	144	95	1572	111	940	100	461000351	461000584
24	4000	>80	3450	143	95	1572	111	940	100	461000353	461000587
33	4000	>80	4820	146	95	1572	111	940	100	461000147	461000590
45	4000	>80	6890	153	95	1572	111	940	100	461000468	461000593
16	4000	>80	2420	151	145	612	111	475	100	461000235	461000598
19	4000	>80	2980	156	145	612	111	475	100	461000325	461000602
27	4000	>80	4090	151	145	612	111	475	100	461000141	461000606
31	4000	>80	4840	156	145	1172	111	700	100	461000218	461000610
37	4000	>80	5950	160	145	1172	111	700	100	461000434	461000615
51	4000	>80	8180	160	145	1172	111	700	100	461000139	461000619
84	4000	>80	11900	141	145	1172	111	700	100	461000525	461000623
38	4000	>80	6050	159	145	1452	111	940	100	461000154	461000625
46	4000	>80	7440	161	145	1452	111	940	100	461000321	461000629
71	4000	>80	10230	144	145	1452	111	940	100	461000158	461000297
104	4000	>80	14880	143	145	1452	111	940	100	461000524	461000635
^{II)} 106	4000	>80	14810	139	145	1452	111	940	100	461000527	461000528

I) Il flusso effettivo potrebbe avere una tolleranza del ±10%. / The effective flux could have a tolerance of ±10%.

II) Questi prodotti sono dotati di un diffusore in policarbonato trasparente e un riflettore per consentire l'emissione a fascio stretto concentrante / These products are equipped with a transparent polycarbonate diffuser and reflector to allow narrow-beam emission

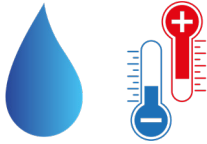

Igloo INOX

Industriale | Industrial

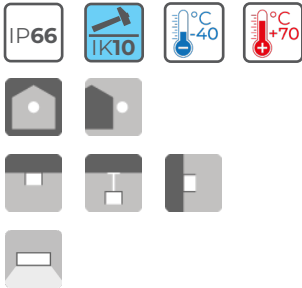

Igloo INOX

Igloo INOX Extreme



Caratteristiche tecniche

Technical Characteristics

- Corpo**
- Policarbonato stabilizzato ai raggi UV, autoestinguento V2
 - Clips di chiusura in acciaio INOX
- Colore**
- Grigio (RAL 7035)
- Gruppo ottico**
- CPT - policarbonato traslucido
- Cablaggio**
- LED ON/OFF con driver integrato
 - LED DALI con driver integrato
- Su richiesta:
- Kit di EMERGENZA (autonomia 1/3 h)
- Grado di protezione**
- IP 66
 - IK 10

- Body**
- V2 self-extinguishing injection-moulded polycarbonate, UV rays stabilized
 - Stainless steel sealing brackets
- Colour**
- Grey (RAL 7035)
- Optical group**
- CPT - translucent polycarbonate
- Wiring**
- LED ON/OFF with integrated driver
 - LED DALI with integrated driver
- On request:
- EMERGENCY kit (1/3 h autonomy)
- Protection degree**
- IP 66
 - IK 10

Sorgenti LED

LED sources

- IRC**
- >80
- Su richiesta:
- >90
- Temp. colore**
- 4000 K
- CRI**
- >80
- On request:
- >90
- Colour Temp.**
- 4000 K

Ottiche

Diffusers

CPT

Diffusore in policarbonato traslucido, stabilizzato ai raggi UV, ad altissima resistenza meccanica.
Translucent polycarbonate diffuser, UV stabilized with high mechanical resistance.

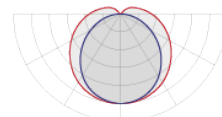

Parete / Wall

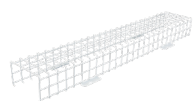

GABBIA PROTETTIVA
PROTECTIVE GRID
Cod. / Code **GBP461001000X**
Protezione metallica di colore bianco.
White metal protection
• **1** : 700 x 200 x 130 mm
• **2** : 1300 x 220 x 130 mm
• **3** : 1600 x 220 x 130 mm



2 pcs. kit

STAFFA DI FISSAGGIO REGOLABILE
ADJUSTABLE WALL BRACKET
Cod. / Code **KPR459023**
Lamiera di acciaio zincato, verniciata bianco.
Completo di viti di fissaggio.
Galvanized steel sheet, white powder coated.
Fixing screws included.

CPT

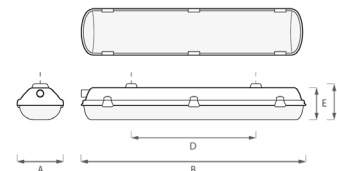
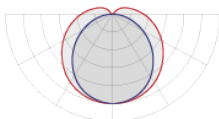

Igloo INOX



Potenza Power [W]	Temp. colore Colour Temp. [K]	IRC CRI	Flusso lum. Lum. flux [lm]	Efficienza lum. Lum. effic. [lm / W]	Dimensioni / Dimensions [mm]					Cod. / Code LED	Cod. / Code LED DALI
					A	B	C	D	E		
8	4000	>80	1170	146	95	662	111	350	100	471000316	471000318
10	4000	>80	1410	141	95	662	111	350	100	471000216	471000236
14	4000	>80	1960	140	95	662	111	350	100	471000317	471000319
16	4000	>80	2300	143	95	1272	111	700	100	471000320	471000321
20	4000	>80	2770	138	95	1272	111	700	100	471000324	471000325
27	4000	>80	3870	143	95	1272	111	700	100	471000328	471000329
38	4000	>80	5570	146	95	1272	111	700	100	471000332	471000333
20	4000	>80	2880	144	95	1572	111	940	100	471000334	471000335
24	4000	>80	3450	143	95	1572	111	940	100	471000338	471000339
33	4000	>80	4820	146	95	1572	111	940	100	471000342	471000343
45	4000	>80	6890	153	95	1572	111	940	100	471000346	471000347
16	4000	>80	2420	151	145	612	111	475	100	471000348	471000349
19	4000	>80	2980	156	145	612	111	475	100	471000352	471000353
27	4000	>80	4090	151	145	612	111	475	100	471000356	471000357
31	4000	>80	4840	156	145	1172	111	700	100	471000360	471000361
37	4000	>80	5950	160	145	1172	111	700	100	471000364	471000365
51	4000	>80	8180	160	145	1172	111	700	100	471000368	471000369
84	4000	>80	11900	141	145	1172	111	700	100	471000372	471000373
38	4000	>80	6050	159	145	1452	111	940	100	471000374	471000375
46	4000	>80	7440	161	145	1452	111	940	100	471000378	471000379
71	4000	>80	10230	144	145	1452	111	940	100	471000207	471000290
104	4000	>80	14880	143	145	1452	111	940	100	471000382	471000383

Igloo Extreme



Potenza Power [W]	Temp. eserc. Operat. Temp. [°C]	Temp. colore Colour Temp. [K]	IRC CRI	Flusso lum. Lum. flux [lm]	Efficienza lum. Lum. effic. [lm / W]	Dimensioni / Dimensions [mm]					Cod. / Code LED	Cod. / Code LED DALI
						A	B	C	D	E		
24	-40 +65	4000	>80	3450	143	95	1572	111	940	100	471000295	471000296
33	-40 +60	4000	>80	4820	146	95	1572	111	940	100	471000297	471000298
24	-40 +70	4000	>80	3650	152	145	1452	111	940	100	471000299	471000300
33	-40 +65	4000	>80	5090	154	145	1452	111	940	100	471000301	471000302
37	-40 +65	4000	>80	5880	158	145	1172	111	700	100	471000384	471000385
51	-40 +60	4000	>80	8190	160	145	1172	111	700	100	471000386	471000387
46	-40 +65	4000	>80	7290	158	145	1452	111	940	100	471000388	471000389
71	-40 +60	4000	>80	11330	159	145	1452	111	940	100	471000390	471000391

1) Il flusso effettivo potrebbe avere una tolleranza del ±10%. / The effective flux could have a tolerance of ±10%.



DOWN- LIGHTS

Pearl ECO

IP
44/20

Pearl ECO



Pearl ECO/Q



Caratteristiche tecniche

Technical Characteristics

Corpo	· Alluminio	Body	· Aluminium
Colore	○ Bianco	Colour	○ White
Gruppo ottico	· MOT - metacrilato opale	Optical group	· MOT - opal methacrylate
Cablaggio	<ul style="list-style-type: none"> · LED ON/OFF con driver remoto incluso · LED DALI con driver remoto incluso Su richiesta: <ul style="list-style-type: none"> · Kit di EMERGENZA (autonomia 1/3 h) 	Wiring	<ul style="list-style-type: none"> · LED ON/OFF with included remote driver · LED DALI with included remote driver On request: <ul style="list-style-type: none"> · EMERGENCY kit (1/3 h autonomy)
Grado di protezione	· IP 44/20	Protection degree	· IP 44/20

Sorgenti LED

LED sources

IRC	· >80	CRI	· >80
Temp. colore	<ul style="list-style-type: none"> · 3000 K · 4000 K 	Colour Temp.	<ul style="list-style-type: none"> · 3000 K · 4000 K

Gruppi ottici

Optical groups

MOT

Diffusore in metacrilato opale ad alta trasmittanza, ideale per una distribuzione uniforme.

Diffuser in opal methacrylate with high transmittance, ideal for uniform distribution.

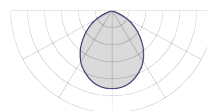

Pearl ECO

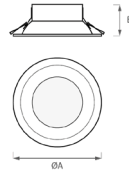
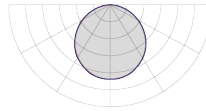

Potenza Power [W]	Temp. colore Colour Temp. [K]	IRC CRI	Flusso lum. Lum. flux [lm]	Efficienza lum. Lum. effic. [lm / W]	Dimensioni / Dimensions [mm]			Cod. / Code LED	Cod. / Code LED DALI
					A (∅)	B	(∅)		
12	3000	>80	1428	119	190	74	170	557400135	557400136
12	4000	>80	1536	128	190	74	170	557400143	557400144
12	3000	>80	1284	107	190	74	170	557400151	557400152
12	4000	>80	1380	115	190	74	170	557400159	557400160
15	3000	>80	2025	135	220	74	200	557400167	557400168
15	4000	>80	2175	145	220	74	200	557400179	557400180
15	3000	>80	1815	121	220	74	200	557400191	557400192
15	4000	>80	1950	130	220	74	200	557400203	557400204
16	3000	>80	1808	113	190	74	170	557400139	557400140
16	4000	>80	1936	121	190	74	170	557400147	557400148
16	3000	>80	1616	101	190	74	170	557400155	557400156
16	4000	>80	1728	108	190	74	170	557400163	557400164
19	3000	>80	2527	133	220	74	200	557400171	557400172
19	4000	>80	2717	143	220	74	200	557400183	557400184
19	3000	>80	2261	119	220	74	200	557400195	557400196
19	4000	>80	2432	128	220	74	200	557400207	557400208
26	3000	>80	3276	126	220	74	200	557400175	557400176
26	4000	>80	3536	136	220	74	200	557400187	557400188
26	3000	>80	2938	113	220	74	200	557400199	557400200
26	4000	>80	3172	122	220	74	200	557400211	557400212

Pearl ECO/Q

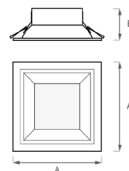
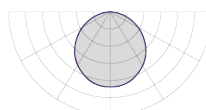

Potenza Power [W]	Temp. colore Colour Temp. [K]	IRC CRI	Flusso lum. Lum. flux [lm]	Efficienza lum. Lum. effic. [lm / W]	Dimensioni / Dimensions [mm]			Cod. / Code LED	Cod. / Code LED DALI
					A	B			
10	3000	>80	1070	107	170	96	155x155	575600002	575600003
10	4000	>80	1118	111	170	96	155x155	575600004	575600005
15	3000	>80	1380	92	170	96	155x155	575600006	575600007
15	4000	>80	1451	96	170	96	155x155	575600008	575600009
19	3000	>80	2220	116	225	96	210x210	575600010	575600011
19	4000	>80	2323	122	225	96	210x210	575600012	575600013
22	3000	>80	2463	111	225	96	210x210	575600014	575600015
22	4000	>80	2584	117	225	96	210x210	575600016	575600017
25	3000	>80	2660	106	255	96	240x240	575600018	575600019
25	4000	>80	2800	112	255	96	240x240	575600020	575600021
29	3000	>80	3130	107	255	96	240x240	575600022	575600023
29	4000	>80	3300	113	255	96	240x240	575600024	575600025

1) Il flusso effettivo potrebbe avere una tolleranza del ±10%. / The effective flux could have a tolerance of ±10%

Giove

IP
44/20

Giove



Giove Q



Caratteristiche tecniche

Technical Characteristics

Corpo	· Alluminio pressofuso	Body	· Die-cast aluminium
Colore	○ Bianco	Colour	○ White
Gruppo ottico	· POL - policarbonato opale · VTR 50° - vetro temprato, fascio 50° · VTR 60° - vetro temprato, fascio 60°	Optical group	· POL - opal polycarbonate · VTR 50° - tempered glass, 50° beam angle · VTR 60° - tempered glass, 60° beam angle
Cablaggio	· LED ON/OFF con driver remoto incluso · LED DALI con driver remoto incluso <u>Su richiesta:</u> · Kit di EMERGENZA (autonomia 1/3 h)	Wiring	· LED ON/OFF with included remote driver · LED DALI with included remote driver <u>On request:</u> · EMERGENCY kit (1/3 h autonomy)
Grado di protezione	· IP 44/20	Protection degree	· IP 44/20

Sorgenti LED

LED sources

IRC	· >80 <u>Su richiesta:</u> · >90	CRI	· >80 <u>On request:</u> · >90
Temp. colore	· 3000 K · 4000 K	Colour Temp.	· 3000 K · 4000 K

Gruppi ottici

Optical groups

POL

Diffusore in policarbonato opale a finitura liscia, ideale per una distribuzione uniforme.
 Diffuser in opal polycarbonate with smooth finish, ideal for uniform distribution.

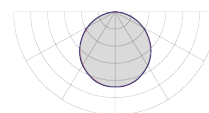

VTR

Diffusore in vetro temprato, fascio di emissione 50° e 60°.
 Tempered glass diffuser, 50° and 60° beam angle.

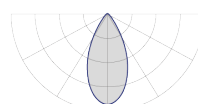

Giove

POL

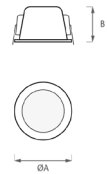
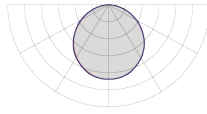

Potenza Power [W]	Temp. colore Colour Temp. [K]	IRC CRI	Flusso lum. Lum. flux [lm]	Efficienza lum. Lum. effic. [lm / W]	Dimensioni / Dimensions [mm]			Cod. / Code LED	Cod. / Code LED DALI
					A (Ø)	B	(Ø)		
15	3000	>80	1056	70	120	70	105	575000060	575000061
15	4000	>80	1099	73	120	70	105	575000066	575000067
20	3000	>80	1471	73	120	70	105	575000062	575000063
20	4000	>80	1533	76	120	70	105	575000068	575000069
24	3000	>80	1784	74	120	70	105	575000163	575000165
24	4000	>80	1861	77	120	70	105	575000164	575000166
20	3000	>80	1471	73	160	100	148	575000072	575000073
20	4000	>80	1533	76	160	100	148	575000078	575000079
28	3000	>80	2002	71	160	100	148	575000074	575000075
28	4000	>80	2085	74	160	100	148	575000080	575000081
35	3000	>80	2504	71	160	100	148	575000076	575000077
35	4000	>80	2678	76	160	100	148	575000082	575000083
20	3000	>80	1471	73	205	100	188	575000084	575000085
20	4000	>80	1533	76	205	100	188	575000090	575000091
28	3000	>80	2002	71	205	100	188	575000086	575000087
28	4000	>80	2085	74	205	100	188	575000092	575000093
42	3000	>80	2863	68	205	100	188	575000088	575000089
42	4000	>80	2981	70	205	100	188	575000094	575000095
20	3000	>80	1471	73	230	117	218	575000096	575000097
20	4000	>80	1533	76	230	117	218	575000102	575000103
28	3000	>80	2002	71	230	117	218	575000098	575000099
28	4000	>80	2085	74	230	117	218	575000104	575000105
42	3000	>80	2863	68	230	117	218	575000100	575000101
42	4000	>80	2981	70	230	117	218	575000106	575000107
50	3000	>80	3372	67	230	117	218	575000108	575000109
50	4000	>80	3608	72	230	117	218	575000110	575000111

Giove Q

POL

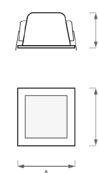
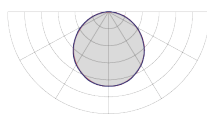

Potenza Power [W]	Temp. colore Colour Temp. [K]	IRC CRI	Flusso lum. Lum. flux [lm]	Efficienza lum. Lum. effic. [lm / W]	Dimensioni / Dimensions [mm]			Cod. / Code LED	Cod. / Code LED DALI
					A	B			
15	3000	>80	1056	70	120	70	105x105	575100013	575100016
15	4000	>80	1099	73	120	70	105x105	575100019	575100022
20	3000	>80	1471	73	120	70	105x105	575100014	575100017
20	4000	>80	1533	76	120	70	105x105	575100020	575100023
24	3000	>80	1784	74	120	70	105x105	575100116	575100118
24	4000	>80	1861	77	120	70	105x105	575100117	575100119
20	3000	>80	1471	73	160	101	148x148	575100037	575100040
20	4000	>80	1533	76	160	101	148x148	575100043	575100046
28	3000	>80	2002	71	160	101	148x148	575100038	575100041
28	4000	>80	2085	74	160	101	148x148	575100044	575100047
35	3000	>80	2504	71	160	101	148x148	575100039	575100042
35	4000	>80	2678	76	160	101	148x148	575100045	575100048
20	3000	>80	1471	73	205	101	188x188	575100061	575100064
20	4000	>80	1533	76	205	101	188x188	575100067	575100070
28	3000	>80	2002	71	205	101	188x188	575100062	575100065
28	4000	>80	2085	74	205	101	188x188	575100068	575100071
42	3000	>80	2863	68	205	101	188x188	575100063	575100066
42	4000	>80	2981	70	205	101	188x188	575100069	575100072
20	3000	>80	1471	73	230	112	218x218	575100089	575100093
20	4000	>80	1533	76	230	112	218x218	575100097	575100101
28	3000	>80	2002	71	230	112	218x218	575100090	575100094
28	4000	>80	2085	74	230	112	218x218	575100098	575100102
42	3000	>80	2863	68	230	112	218x218	575100091	575100095
42	4000	>80	2981	70	230	112	218x218	575100099	575100103
50	3000	>80	3372	67	230	112	218x218	575100092	575100096
50	4000	>80	3608	72	230	112	218x218	575100100	575100104

1) Il flusso effettivo potrebbe avere una tolleranza del ±10%. / The effective flux could have a tolerance of ±10%

Giove

VTR

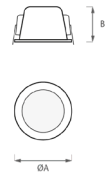
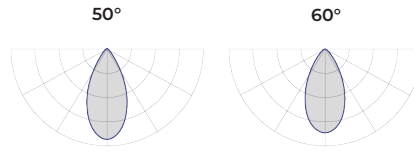

Potenza Power [W]	Lente Lens	Temp. colore Colour Temp. [K]	IRC CRI	Flusso lum. Lum. flux [lm]	Efficienza lum. Lum. effic. [lm / W]	Dimensioni / Dimensions [mm]			Cod. / Code LED	Cod. / Code LED DALI
						A (Ø)	B	Ø (Ø)		
15	50°	3000	>80	1537	102	120	70	105	575000008	575000009
15	50°	4000	>80	1599	106	120	70	105	575000014	575000015
20	50°	3000	>80	2141	107	120	70	105	575000010	575000011
20	50°	4000	>80	2230	111	120	70	105	575000016	575000017
24	50°	3000	>80	2596	108	120	70	105	575000159	575000013
24	50°	4000	>80	2708	112	120	70	105	575000160	575000019
20	50°	3000	>80	2141	107	160	100	148	575000020	575000021
20	50°	4000	>80	2230	111	160	100	148	575000026	575000027
28	50°	3000	>80	2913	104	160	100	148	575000022	575000023
28	50°	4000	>80	3034	108	160	100	148	575000028	575000029
35	50°	3000	>80	3643	104	160	100	148	575000024	575000025
35	50°	4000	>80	3896	111	160	100	148	575000030	575000031
20	60°	3000	>80	2141	107	205	100	188	575000032	575000033
20	60°	4000	>80	2230	111	205	100	188	575000038	575000039
28	60°	3000	>80	2913	104	205	100	188	575000034	575000035
28	60°	4000	>80	3034	108	205	100	188	575000040	575000041
42	60°	3000	>80	4165	99	205	100	188	575000036	575000037
42	60°	4000	>80	4337	103	205	100	188	575000042	575000043
20	60°	3000	>80	2141	107	230	117	218	575000044	575000045
20	60°	4000	>80	2230	111	230	117	218	575000050	575000051
28	60°	3000	>80	2913	104	230	117	218	575000046	575000047
28	60°	4000	>80	3034	108	230	117	218	575000052	575000053
42	60°	3000	>80	4165	99	230	117	218	575000048	575000049
42	60°	4000	>80	4337	103	230	117	218	575000054	575000055
50	60°	3000	>80	4906	98	230	117	218	575000056	575000057
50	60°	4000	>80	5248	104	230	117	218	575000058	575000059

Giove Q

VTR

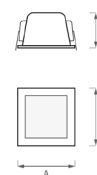
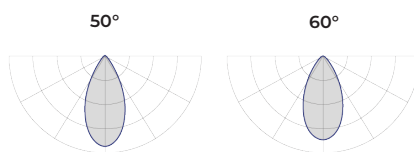

Potenza Power [W]	Lente Lens	Temp. colore Colour Temp. [K]	IRC CRI	Flusso lum. Lum. flux [lm]	Efficienza lum. Lum. effic. [lm / W]	Dimensioni / Dimensions [mm]			Cod. / Code LED	Cod. / Code LED DALI
						A	B			
15	50°	3000	>80	1537	102	120	70	105x105	575100001	575100004
15	50°	4000	>80	1599	106	120	70	105x105	575100007	575100010
20	50°	3000	>80	2141	107	120	70	105x105	575100002	575100005
20	50°	4000	>80	2230	111	120	70	105x105	575100008	575100011
24	50°	3000	>80	2596	108	120	70	105x105	575100112	575100114
24	50°	4000	>80	2708	112	120	70	105x105	575100113	575100115
20	50°	3000	>80	2141	107	160	101	148x148	575100025	575100028
20	50°	4000	>80	2230	111	160	101	148x148	575100031	575100034
28	50°	3000	>80	2913	104	160	101	148x148	575100026	575100029
28	50°	4000	>80	3034	108	160	101	148x148	575100032	575100035
35	50°	3000	>80	3643	104	160	101	148x148	575100027	575100030
35	50°	4000	>80	3896	111	160	101	148x148	575100033	575100036
20	60°	3000	>80	2141	107	205	101	188x188	575100049	575100052
20	60°	4000	>80	2230	111	205	101	188x188	575100055	575100058
28	60°	3000	>80	2913	104	205	101	188x188	575100050	575100053
28	60°	4000	>80	3034	108	205	101	188x188	575100056	575100059
42	60°	3000	>80	4165	99	205	101	188x188	575100051	575100054
42	60°	4000	>80	4337	103	205	101	188x188	575100057	575100060
20	60°	3000	>80	2141	107	230	112	218x218	575100073	575100077
20	60°	4000	>80	2230	111	230	112	218x218	575100081	575100085
28	60°	3000	>80	2913	104	230	112	218x218	575100074	575100078
28	60°	4000	>80	3034	108	230	112	218x218	575100082	575100086
42	60°	3000	>80	4165	99	230	112	218x218	575100075	575100079
42	60°	4000	>80	4337	103	230	112	218x218	575100083	575100087
50	60°	3000	>80	4906	98	230	112	218x218	575100076	575100080
50	60°	4000	>80	5248	104	230	112	218x218	575100084	575100088

1) Il flusso effettivo potrebbe avere una tolleranza del ±10%. / The effective flux could have a tolerance of ±10%

Disque



Disque



Disque Q



Caratteristiche tecniche

Technical Characteristics

Corpo	· Alluminio e materiale termoplastico	Body	· Aluminium and thermoplastic material
Colore	○ Bianco	Colour	○ White
Gruppo ottico	· MOT - metacrilato opale, fascio 120°	Optical group	· MOT - opal methacrylate, 120° beam angle
Cablaggio	· LED ON/OFF con driver integrato incluso	Wiring	· LED ON/OFF with integrated driver
Grado di protezione	· IP 44/20	Protection degree	· IP 44/20

Sorgenti LED

LED sources

IRC	· >80	CRI	· >80
Temp. colore	· 3000 K · 4000 K	Colour Temp.	· 3000 K · 4000 K

Gruppi ottici
Optical groups

MOT

Diffusore in metacrilato opale ad alta trasmittanza, ideale per una distribuzione uniforme.

Diffuser in opal methacrylate with high transmittance, ideal for uniform distribution.

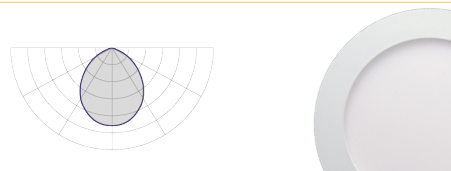

Disque

MOT

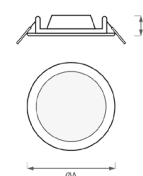
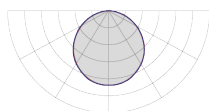

Potenza Power [W]	Temp. colore Colour Temp. [K]	IRC CRI	Flusso lum. Lum. flux [lm]	Efficienza lum. Lum. effic. [lm / W]	Dimensioni / Dimensions [mm]			Cod. / Code LED
					A (Ø)	B	Ø (Ø)	
6	3000	>80	350	58	115	31	100-110	572000055
6	4000	>80	390	65	115	31	100-110	572000056
12	3000	>80	780	65	170	32	150-160	572000057
12	4000	>80	850	70	170	32	150-160	572000058
18	3000	>80	1350	75	220	32	200-210	572000059
18	4000	>80	1450	80	220	32	200-210	572000060
20	3000	>80	1500	75	240	32	220-230	572000061
20	4000	>80	1600	80	240	32	220-230	572000062

Disque Q

MOT

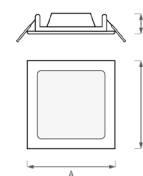
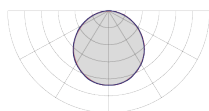

Potenza Power [W]	Temp. colore Colour Temp. [K]	IRC CRI	Flusso lum. Lum. flux [lm]	Efficienza lum. Lum. effic. [lm / W]	Dimensioni / Dimensions [mm]			Cod. / Code LED
					A	B	Ø (Ø)	
6	3000	>80	350	58	115	32	105X105	573600001
6	4000	>80	390	65	115	32	105X105	573600002
12	3000	>80	780	65	165	32	155X155	573600003
12	4000	>80	850	70	165	32	155X155	573600004
18	3000	>80	1350	75	220	32	205X205	573600005
18	4000	>80	1450	80	220	32	205X205	573600006

1) Il flusso effettivo potrebbe avere una tolleranza del ±10%. / The effective flux could have a tolerance of ±10%

LDR

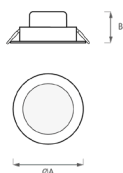
IP
44/20

Caratteristiche tecniche

Technical Characteristics

Corpo	· Alluminio e materiale termoplastico	Body	· Aluminium and thermoplastic material
Colore	○ Bianco	Colour	○ White
Gruppo ottico	· PSO - policarbonato opale, fascio 90°	Optical group	· PSO - opal polycarbonate, 90° beam angle
Cablaggio	· LED DIM TRIAC con driver integrato <u>Su richiesta:</u> · Kit di EMERGENZA (autonomia 1 h)	Wiring	· LED DIM TRIAC with integrated driver <u>On request:</u> · EMERGENCY kit (1 h autonomy)
Grado di protezione	· IP 44/20	Protection degree	· IP 44/20

Sorgenti LED

LED sources

IRC	· >80	CRI	· >80
Temp. colore	· 3000/4000/6000 K - settabile	Colour Temp.	· 3000/4000/6000 K - switchable

Gruppi ottici

Optical groups

PSO

Diffusore in policarbonato opale, ideale per una distribuzione uniforme.
Diffuser in opal polycarbonate, ideal for uniform distribution.

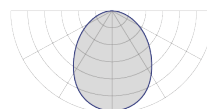

PSO



Potenza Power [W]	Fascio Beam angle	Temp. colore Colour Temp. [K]	IRC CRI	Flusso lum. Lum. flux [lm]	Efficienza lum. Lum. eff. [lm / W]	Dimensioni / Dimensions [mm]			Cod. / Code LED DIM TRIAC
						A (Ø)	B	Ø	
10	90°	3000/4000/6000	>80	930/1000/100	93/100/100	113	59	90 - 102	573500009
14	90°	3000/4000/6000	>80	1300/1400/1400	92/100/100	145	66	120 - 130	573500010
17	90°	3000/4000/6000	>80	1580/1700/1700	92/100/100	174	69	145 - 155	573500011
25	90°	3000/4000/6000	>80	2400/2600/2600	96/104/104	244	85	195 - 210	573500012

DWN UGR

IP 44/20 UGR <19

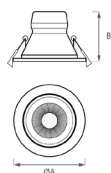

Caratteristiche tecniche

Technical Characteristics

Corpo	· Alluminio e materiale termoplastico	Body	· Aluminium and thermoplastic material
Colore	○ Bianco	Colour	○ White
Gruppo ottico	· FCT - lente in alluminio satinato, fascio 60°	Optical group	· FCT - satin aluminium lens, 60° beam angle
Cablaggio	· LED ON/OFF con driver remoto incluso · LED DALI con driver remoto incluso <u>Su richiesta:</u> · Kit di EMERGENZA (autonomia 1/3 h)	Wiring	· LED ON/OFF with included remote driver · LED DALI with included remote driver <u>On request:</u> · EMERGENCY kit (1/3 h autonomy)
Grado di protezione	· IP 44/20	Protection degree	· IP 44/20

Sorgenti LED

LED sources

IRC	· >80	CRI	· >80
Temp. colore	· 3000/4000/6000 K - settabile	Colour Temp.	· 3000/4000/6000 K - switchable

Gruppi ottici

Optical groups

FCT

Riflettore interno in alluminio anodizzato puro con diffusore satinato a protezione della sorgente luminosa. Ottica con emissione luminosa controllata con valori di luminanza <3000 ca/m² per angoli di emissione superiori a 65° su tutti i piani (UGR<19), idonea per l'installazione in presenza di videotermini in conformità con le norme UNI EN 12464-1. Apertura di fascio 60°.

Internal reflector in pure anodized aluminium with satin diffuser to protect the light source. Controlled light emission optics with luminance values <3000 ca/m² for emission angles >65° (UGR<19), suitable for installation in workplaces with the use of videoterminals according to UNI EN 12464-1 standards. 60° beam angle.



60° UGR <19



Potenza Power [W]	Fascio Beam angle	Temp. colore Colour Temp. [K]	IRC CRI	Flusso lum. Lum. flux [lm]	Efficienza lum. Lum. effic. [lm / W]	Dimensioni / Dimensions [mm]			Cod. / Code LED	Cod. / Code LED DALI
						A (Ø)	B	Ø		
6	60°	3000/4000/6000	>80	455/490/490	75/81/81	95	57	68-80	538100011	-
10	60°	3000/4000/6000	>80	800/880/800	80/88/88	113	69	90-102	538100012	538100013
15	60°	3000/4000/6000	>80	1200/1320/1320	80/88/88	145	82	120-130	538100014	538100015
20	60°	3000/4000/6000	>80	1640/1800/1800	82/90/90	174	89	145-155	538100016	538100009
35	60°	3000/4000/6000	>80	2870/3150/3150	82/90/90	232	113	195-210	538100017	538100010

I) Il flusso effettivo potrebbe avere una tolleranza del ±10%. / The effective flux could have a tolerance of ±10%

Visual

IP20 UGR <17



Visual



Visual Q



Caratteristiche tecniche

Technical Characteristics

Corpo · Alluminio pressofuso

Colore ○ Bianco

Gruppo ottico Riflettore metallizzato e lente in policarbonato (UGR<17)

- Fascio 50°
- Fascio 55°
- Fascio 60°

Cablaggio

- LED ON/OFF con driver remoto incluso
- LED DALI con driver remoto incluso

Su richiesta:

- Kit di EMERGENZA (autonomia 1/3 h)

Grado di protezione

- IP 20

Body · Die-cast aluminium

Colour ○ White

Optical group Metallic reflector and polycarbonate lens (UGR<17)

- 50° beam angle
- 55° beam angle
- 60° beam angle

Wiring

- LED ON/OFF with included remote driver
- LED DALI with included remote driver

On request:

- EMERGENCY kit (1/3 h autonomy)

Protection degree

- IP 20

Sorgenti LED

LED sources

IRC

- >80

Su richiesta:

- >90

Temp. colore

- 3000 K
- 4000 K

CRI

- >80

On request:

- >90

Colour Temp.

- 3000 K
- 4000 K

Gruppi ottici

Optical groups

Lente in policarbonato trasparente con riflettore metallizzato ad emissione luminosa controllata (UGR<17) con valori di luminanza <1500 cd/m² per angoli di emissione superiori ai 65° su tutti i piani e quindi conforme ad essere installata in ambienti con uso di videotermini secondo la norma UNI EN 12464-1.

Versioni disponibili con angoli di emissione 50°, 55° e 60°.

Transparent polycarbonate lens with controlled light emission metallic reflector (UGR<17). Luminance values <1500 cd/m² for emission angles >65, suitable for installation in workplaces with the use of videoterminals according to UNI EN 12464-1 standards. Versions available with 50°, 55° and 60° beam angles.

UGR
<19



50°

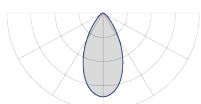

55°



60°



Visual

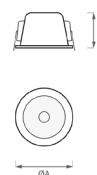
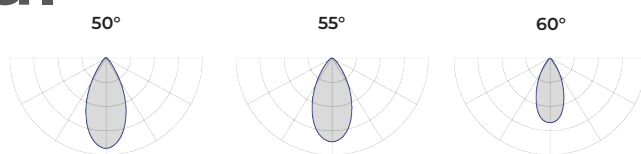

Potenza Power [W]	Lente Lens	Temp. colore Colour Temp. [K]	IRC CRI	Flusso lum. Lum. flux [lm]	Efficienza lum. Lum. effic. [lm / W]	Dimensioni / Dimensions [mm]			Cod. / Code LED	Cod. / Code LED DALI
						A (Ø)	B	(Ø)		
12	50°	3000	>80	1245	103	80	60	70	575200063	575200064
12	50°	4000	>80	1309	109	80	60	70	575200061	575200062
12	55°	3000	>80	1343	111	105	80	100	575200001	575200004
12	55°	4000	>80	1410	117	105	80	100	575200007	575200010
17	55°	3000	>80	1860	109	105	80	100	575200002	575200005
17	55°	4000	>80	1950	114	105	80	100	575200008	575200011
21	55°	3000	>80	2187	104	105	80	100	575200003	575200006
21	55°	4000	>80	2295	109	105	80	100	575200009	575200012
12	55°	3000	>80	1343	111	125	90	115	575200019	575200022
12	55°	4000	>80	1410	117	125	90	115	575200013	575200016
17	55°	3000	>80	1860	109	125	90	115	575200020	575200023
17	55°	4000	>80	1950	114	125	90	115	575200014	575200017
24	55°	3000	>80	2498	104	125	90	115	575200021	575200024
24	55°	4000	>80	2625	109	125	90	115	575200015	575200018
17	55°	3000	>80	1860	109	155	105	145	575200025	575200028
17	55°	4000	>80	1950	114	155	105	145	575200031	575200034
24	55°	3000	>80	2498	104	155	105	145	575200026	575200029
24	55°	4000	>80	2625	109	155	105	145	575200032	575200035
32	55°	3000	>80	3079	96	155	105	145	575200027	575200030
32	55°	4000	>80	3233	101	155	105	145	575200033	575200036
17	60°	3000	>80	2059	121	210	114	200	575200037	575200052
17	60°	4000	>80	2145	126	210	114	200	575200055	575200058
25	60°	3000	>80	2802	112	210	114	200	575200050	575200053
25	60°	4000	>80	2918	116	210	114	200	575200056	575200059
39	60°	3000	>80	4005	102	210	114	200	575200051	575200054
39	60°	4000	>80	4170	106	210	114	200	575200057	575200060

Visual Q

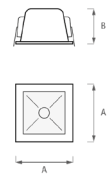
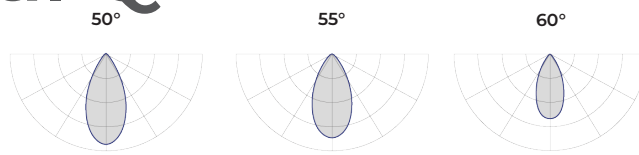

Potenza Power [W]	Lente Lens	Temp. colore Colour Temp. [K]	IRC CRI	Flusso lum. Lum. flux [lm]	Efficienza lum. Lum. effic. [lm / W]	Dimensioni / Dimensions [mm]			Cod. / Code LED	Cod. / Code LED DALI
						A	B			
12	50°	3000	>80	1245	103	80	49	70x70	573700001	573700002
12	50°	4000	>80	1309	109	80	49	70x70	573700003	573700004
12	55°	3000	>80	1343	111	105	63	95x95	573700005	573700006
12	55°	4000	>80	1410	117	105	63	95x95	573700007	573700008
17	55°	3000	>80	1860	109	105	63	95x95	573700009	573700010
17	55°	4000	>80	1950	114	105	63	95x95	573700011	573700012
21	55°	3000	>80	2187	104	105	63	95x95	573700013	573700014
21	55°	4000	>80	2295	109	105	63	95x95	573700015	573700016
12	55°	3000	>80	1343	111	125	72	115x115	573700017	573700018
12	55°	4000	>80	1410	117	125	72	115x115	573700019	573700020
17	55°	3000	>80	1860	109	125	72	115x115	573700021	573700022
17	55°	4000	>80	1950	114	125	72	115x115	573700023	573700024
24	55°	3000	>80	2498	104	125	72	115x115	573700025	573700026
24	55°	4000	>80	2625	109	125	72	115x115	573700027	573700028
17	55°	3000	>80	1860	109	155	85	142x142	573700029	573700030
17	55°	4000	>80	1950	114	155	85	142x142	573700031	573700032
24	55°	3000	>80	2498	104	155	85	142x142	573700033	573700034
24	55°	4000	>80	2625	109	155	85	142x142	573700035	573700036
32	55°	3000	>80	3079	96	155	85	142x142	573700037	573700038
32	55°	4000	>80	3233	101	155	85	142x142	573700039	573700040
17	60°	3000	>80	2059	121	210	103	196x196	573700041	573700042
17	60°	4000	>80	2145	126	210	103	196x196	573700043	573700044
25	60°	3000	>80	2802	112	210	103	196x196	573700045	573700046
25	60°	4000	>80	2918	116	210	103	196x196	573700047	573700048
39	60°	3000	>80	4005	102	210	103	196x196	573700049	573700050
39	60°	4000	>80	4170	106	210	103	196x196	573700051	573700052

1) Il flusso effettivo potrebbe avere una tolleranza del ±10%. / The effective flux could have a tolerance of ±10%

Shade

IP
40/20UGR
<19

Caratteristiche tecniche

Technical Characteristics

Corpo	<ul style="list-style-type: none"> Alluminio pressofuso 	Body	<ul style="list-style-type: none"> Die-cast aluminium
Colore	<ul style="list-style-type: none"> ○ Bianco (RAL 9003) <p><u>Su richiesta:</u></p> <ul style="list-style-type: none"> ● Grigio ● Nero 	Colour	<ul style="list-style-type: none"> ○ White (RAL 9003) <p><u>Su richiesta:</u></p> <ul style="list-style-type: none"> ● Grey ● Black
Gruppo ottico	<ul style="list-style-type: none"> Riflettore interno in alluminio metallizzato, copertura inferiore in VTR - vetro trasparente. Fascio 45° 	Optical group	<ul style="list-style-type: none"> Internal reflector in metallic aluminium, VTR - transparent glass lower cover. 45° beam angle
Cablaggio	<ul style="list-style-type: none"> LED ON/OFF con driver remoto incluso LED DALI con driver remoto incluso <p><u>Su richiesta:</u></p> <ul style="list-style-type: none"> Kit di EMERGENZA (autonomia 1/3 h) 	Wiring	<ul style="list-style-type: none"> LED ON/OFF with included remote driver LED DALI with included remote driver <p><u>On request:</u></p> <ul style="list-style-type: none"> EMERGENCY kit (1/3 h autonomy)
Grado di protezione	<ul style="list-style-type: none"> IP 40/20 	Protection degree	<ul style="list-style-type: none"> IP 40/20

Sorgenti LED

LED sources

IRC	<ul style="list-style-type: none"> >80 >90 	CRI	<ul style="list-style-type: none"> >80 >90
Temp. colore	<ul style="list-style-type: none"> 3000 K 4000 K 	Colour Temp.	<ul style="list-style-type: none"> 3000 K 4000 K

Gruppi ottici

Optical groups

VTR

Riflettore interno in alluminio sfaccettato con copertura in vetro trasparente (VTR). Ottica con emissione luminosa controllata con valori di luminanza <15000 ca/m² per angoli di emissione superiori a 65° su tutti i piani (UGR<19), idonea per l'installazione in presenza di videotermini in conformità con le norme UNI EN 12464-1. Apertura di fascio 45°.

Internal reflector in multifaceted aluminium and transparent glass cover (VTR). Controlled light emission optics with luminance values <15000 ca/m² for emission angles >65° (UGR<19), suitable for installation in workplaces with the use of videotermini according to UNI EN 12464-1 standards. 45° beam angle.

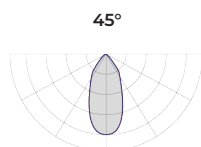
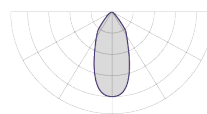

VTR



Potenza Power [W]	Lente Lens	Temp. colore Colour Temp. [K]	IRC CRI	Flusso lum. Lum. flux [lm]	Efficienza lum. Lum. effic. [lm / W]	Dimensioni / Dimensions [mm]			Cod. / Code LED	Cod. / Code LED DALI
						A (Ø)	B	Ø (Ø)		
10	45°	3000	>80	1200	120	151	128	140	575900001	575900005
10	45°	4000	>80	1250	125	151	128	140	575900009	575900013
10	45°	3000	>90	1000	100	151	128	140	575900017	575900021
10	45°	4000	>90	1120	112	151	128	140	575900025	575900029
19	45°	3000	>80	2300	121	151	128	140	575900002	575900006
19	45°	4000	>80	2400	126	151	128	140	575900010	575900014
19	45°	3000	>90	1900	100	151	128	140	575900018	575900022
19	45°	4000	>90	2150	114	151	128	140	575900026	575900030
26	45°	3000	>80	3100	119	151	128	140	575900003	575900007
26	45°	4000	>80	3250	125	151	128	140	575900011	575900015
30	45°	3000	>90	2900	97	151	128	140	575900019	575900023
30	45°	4000	>90	3200	107	151	128	140	575900027	575900031
33	45°	3000	>80	4100	124	151	128	140	575900004	575900008
33	45°	4000	>80	4300	130	151	128	140	575900012	575900016
39	45°	3000	>90	4000	103	151	128	140	575900020	575900024
39	45°	4000	>90	4250	109	151	128	140	575900028	575900032

1) Il flusso effettivo potrebbe avere una tolleranza del ±10%. / The effective flux could have a tolerance of ±10%



Rain

IP
65/20

UGR
<19



Caratteristiche tecniche

Technical Characteristics

Corpo · Alluminio pressofuso

Body · Die-cast aluminium

Colore ○ Bianco (RAL 9003)

Colour ○ White (RAL 9003)

Su richiesta:

● Grigio

● Nero

Su richiesta:

● Grey

● Black

Gruppo ottico Riflettore interno in alluminio metallizzato, copertura inferiore in VTR - vetro trasparente. Fascio 60°

Optical group Internal reflector in metallic aluminium, VTR - transparent glass lower cover. 60° beam angle

Su richiesta:

· Fascio 15°

· Fascio 30°

· Fascio 45°

On request:

· 15° beam angle

· 30° beam angle

· 45° beam angle

Cablaggio · LED ON/OFF con driver remoto incluso
· LED DALI con driver remoto incluso

Wiring · LED ON/OFF with included remote driver
· LED DALI with included remote driver

Su richiesta:

· Kit di EMERGENZA (autonomia 1/3 h)

On request:

· EMERGENCY kit (1/3 h autonomy)

Grado di protezione · IP 65/20

Protection degree · IP 65/20

Sorgenti LED

LED sources

IRC · >80
· >90

CRI · >80
· >90

Temp. colore · 3000 K
· 4000 K

Colour Temp. · 3000 K
· 4000 K

Gruppi ottici

Optical groups

VTR

Riflettore interno in alluminio sfaccettato con copertura in vetro trasparente (VTR). Ottica con emissione luminosa controllata con valori di luminanza <15000 ca/m² per angoli di emissione superiori a 65° su tutti i piani (UGR<19), idonea per l'installazione in presenza di videotermini in conformità con le norme UNI EN 12464-1. Apertura di fascio 60°.

Internal reflector in multifaceted aluminium and transparent glass cover (VTR). Controlled light emission optics with luminance values <15000 ca/m² for emission angles >65° (UGR<19), suitable for installation in workplaces with the use of videoterminals according to UNI EN 12464-1 standards. 60° beam angle.

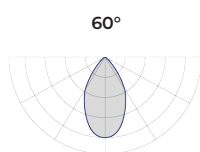
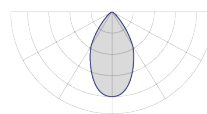

VTR



Potenza Power [W]	Lente Lens	Temp. colore Colour Temp. [K]	IRC CRI	Flusso lum. Lum. flux [lm]	Efficienza lum. Lum. eff. [lm / W]	Dimensioni / Dimensions [mm]			Cod. / Code LED	Cod. / Code LED DALI
						A (Ø)	B	(Ø)		
10	60°	3000	>80	1255	125	150	132	140	576000001	576000004
10	60°	4000	>80	1257	125	150	132	140	576000007	576000010
10	60°	3000	>90	1050	105	150	132	140	576000013	576000016
10	60°	4000	>90	1100	110	150	132	140	576000019	576000022
19	60°	3000	>80	2360	124	150	132	140	576000002	576000005
19	60°	4000	>80	2363	124	150	132	140	576000008	576000011
19	60°	3000	>90	2000	105	150	132	140	576000014	576000017
19	60°	4000	>90	2150	113	150	132	140	576000020	576000023
26	60°	3000	>80	3190	122	150	132	140	576000003	576000006
26	60°	4000	>80	3268	122	150	132	140	576000009	576000012
26	60°	3000	>90	3000	100	150	132	140	576000015	576000018
26	60°	4000	>90	3230	107	150	132	140	576000021	576000024

1) Il flusso effettivo potrebbe avere una tolleranza del ±10%. / The effective flux could have a tolerance of ±10%

Point



Point R



Point R/ADJ



Point R/ADJ Frameless



Point S



Point S/ADJ



Point S/ADJ Frameless



Caratteristiche tecniche

Technical Characteristics

Corpo	· Alluminio pressofuso	Body	· Die-cast aluminium
Colore	○ Bianco	Colour	○ White
Gruppo ottico	Riflettore interno in policarbonato metallizzato. Fascio 55°	Optical group	Internal reflector in metallic polycarbonate. 55° beam angle
Cablaggio	· LED ON/OFF con driver remoto incluso · LED DALI con driver remoto incluso <u>Su richiesta:</u> · Kit di EMERGENZA (autonomia 1/3 h)	Wiring	· LED ON/OFF with included remote driver · LED DALI with included remote driver <u>On request:</u> · EMERGENCY kit (1/3 h autonomy)
Grado di protezione	· IP 40/20	Protection degree	· IP 40/20

Sorgenti LED

LED sources

IRC	· >80 · >90	CRI	· >80 · >90
Temp. colore	· 3000 K · 4000 K	Colour Temp.	· 3000 K · 4000 K

Gruppi ottici

Optical groups

Riflettore interno in policarbonato metallizzato con lente opale protettiva.
Apertura di fascio 55°.
Internal reflector in metallic polycarbonate with opal protective lens.
55° beam angle.

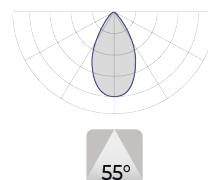

Point R

55°

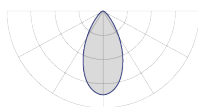

Potenza Power [W]	Lente Lens 55°	Temp. colore Colour Temp. [K]	IRC CRI	Flusso lum. Lum. flux [lm]	Efficienza lum. Lum. effic. [lm / W]	Dimensioni / Dimensions [mm]			Cod. / Code LED	Cod. / Code LED DALI
						A (Ø)	B	Ø (Ø)		
5	55°	3000	>80	693	138	83	93	72	571200148	571200149
5	55°	4000	>80	727	145	83	93	72	571200150	571200151
5	55°	3000	>90	535	107	83	93	72	571200168	571200173
5	55°	4000	>90	660	132	83	93	72	571200178	571200183
7	55°	3000	>80	904	129	83	93	72	571200152	571200153
7	55°	4000	>80	949	135	83	93	72	571200154	571200155
7	55°	3000	>90	698	99	83	93	72	571200169	571200174
7	55°	4000	>90	862	123	83	93	72	571200179	571200184
9	55°	3000	>80	1106	122	83	93	72	571200156	571200157
9	55°	4000	>80	1160	128	83	93	72	571200158	571200159
9	55°	3000	>90	854	94	83	93	72	571200170	571200175
9	55°	4000	>90	1053	117	83	93	72	571200180	571200185
11	55°	3000	>80	1298	118	83	113	72	571200160	571200161
11	55°	4000	>80	1365	124	83	113	72	571200162	571200163
11	55°	3000	>90	1001	91	83	113	72	571200171	571200176
11	55°	4000	>90	1059	96	83	113	72	571200181	571200186
13	55°	3000	>80	1486	114	83	113	72	571200164	571200165
13	55°	4000	>80	1555	119	83	113	72	571200166	571200167
13	55°	3000	>90	1141	87	83	113	72	571200172	571200177
13	55°	4000	>90	1207	92	83	113	72	571200182	571200187

Point S

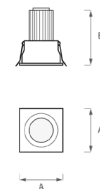
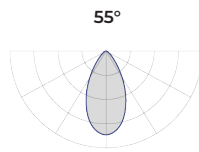

Potenza Power [W]	Lente Lens 55°	Temp. colore Colour Temp. [K]	IRC CRI	Flusso lum. Lum. flux [lm]	Efficienza lum. Lum. effic. [lm / W]	Dimensioni / Dimensions [mm]			Cod. / Code LED	Cod. / Code LED DALI
						A	B	Ø		
5	55°	3000	>80	693	138	83	93	72	572600008	572600013
5	55°	4000	>80	727	145	83	93	72	572600018	572600023
5	55°	3000	>90	535	107	83	93	72	572600028	572600033
5	55°	4000	>90	660	132	83	93	72	572600038	572600043
7	55°	3000	>80	904	129	83	93	72	572600009	572600014
7	55°	4000	>80	949	135	83	93	72	572600019	572600024
7	55°	3000	>90	698	99	83	93	72	572600029	572600034
7	55°	4000	>90	862	123	83	93	72	572600039	572600044
9	55°	3000	>80	1106	122	83	93	72	572600010	572600015
9	55°	4000	>80	1160	128	83	93	72	572600020	572600025
9	55°	3000	>90	854	94	83	93	72	572600030	572600035
9	55°	4000	>90	1053	117	83	93	72	572600040	572600045
11	55°	3000	>80	1298	118	83	113	72	572600011	572600016
11	55°	4000	>80	1365	124	83	113	72	572600021	572600026
11	55°	3000	>90	1001	91	83	113	72	572600031	572600036
11	55°	4000	>90	1059	96	83	113	72	572600041	572600046
13	55°	3000	>80	1486	114	83	113	72	572600012	572600017
13	55°	4000	>80	1555	119	83	113	72	572600022	572600027
13	55°	3000	>90	1141	87	83	113	72	572600032	572600037
13	55°	4000	>90	1207	92	83	113	72	572600042	572600047

1) Il flusso effettivo potrebbe avere una tolleranza del ±10%. / The effective flux could have a tolerance of ±10%

Point R/ADJ

55°

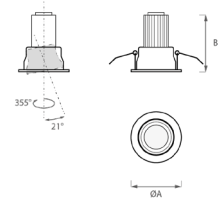
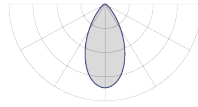

Potenza Power [W]	Lente Lens [°]	Temp. colore Colour Temp. [K]	IRC CRI	Flusso lum. Lum. flux [lm]	Efficienza lum. Lum. effic. [lm / W]	Dimensioni / Dimensions [mm]			Cod. / Code LED	Cod. / Code LED DALI
						A (Ø)	B	ØA (Ø)		
5	55°	3000	>80	693	138	90	93	83	572200023	572200028
5	55°	4000	>80	727	145	90	93	83	572200033	572200038
5	55°	3000	>90	535	107	90	93	83	572200043	572200048
5	55°	4000	>90	660	132	90	93	83	572200053	572200058
7	55°	3000	>80	904	129	90	93	83	572200024	572200029
7	55°	4000	>80	949	135	90	93	83	572200034	572200039
7	55°	3000	>90	698	99	90	93	83	572200044	572200049
7	55°	4000	>90	862	123	90	93	83	572200054	572200059
9	55°	3000	>80	1106	122	90	93	83	572200025	572200030
9	55°	4000	>80	1160	128	90	93	83	572200035	572200040
9	55°	3000	>90	854	94	90	93	83	572200045	572200050
9	55°	4000	>90	1053	117	90	93	83	572200055	572200060
11	55°	3000	>80	1298	118	90	113	83	572200026	572200031
11	55°	4000	>80	1365	124	90	113	83	572200036	572200041
11	55°	3000	>90	1001	91	90	113	83	572200046	572200051
11	55°	4000	>90	1059	96	90	113	83	572200056	572200061
13	55°	3000	>80	1486	114	90	113	83	572200027	572200032
13	55°	4000	>80	1555	119	90	113	83	572200037	572200042
13	55°	3000	>90	1141	87	90	113	83	572200047	572200052
13	55°	4000	>90	1207	92	90	113	83	572200057	572200062

Point S/ADJ

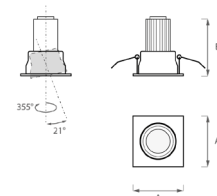
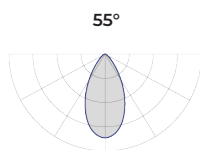

Potenza Power [W]	Lente Lens [°]	Temp. colore Colour Temp. [K]	IRC CRI	Flusso lum. Lum. flux [lm]	Efficienza lum. Lum. effic. [lm / W]	Dimensioni / Dimensions [mm]			Cod. / Code LED	Cod. / Code LED DALI
						A	B	(Ø)		
5	55°	3000	>80	693	138	90	93	80	575400001	575400006
5	55°	4000	>80	727	145	90	93	80	575400011	575400016
5	55°	3000	>90	535	107	90	93	80	575400021	575400026
5	55°	4000	>90	660	132	90	93	80	575400031	575400036
7	55°	3000	>80	904	129	90	93	80	575400002	575400007
7	55°	4000	>80	949	135	90	93	80	575400012	575400017
7	55°	3000	>90	698	99	90	93	80	575400022	575400027
7	55°	4000	>90	862	123	90	93	80	575400032	575400037
9	55°	3000	>80	1106	122	90	93	80	575400003	575400008
9	55°	4000	>80	1160	128	90	93	80	575400013	575400018
9	55°	3000	>90	854	94	90	93	80	575400023	575400028
9	55°	4000	>90	1053	117	90	93	80	575400033	575400038
11	55°	3000	>80	1298	118	90	113	80	575400004	575400009
11	55°	4000	>80	1365	124	90	113	80	575400014	575400019
11	55°	3000	>90	1001	91	90	113	80	575400024	575400029
11	55°	4000	>90	1059	96	90	113	80	575400034	575400039
13	55°	3000	>80	1486	114	90	113	80	575400005	575400010
13	55°	4000	>80	1555	119	90	113	80	575400015	575400020
13	55°	3000	>90	1141	87	90	113	80	575400025	575400030
13	55°	4000	>90	1207	92	90	113	80	575400035	575400040

Point R/ADJ Frameless

55°

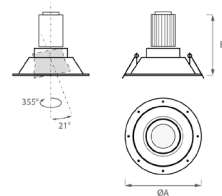
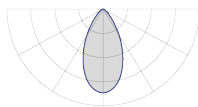

Potenza Power [W]	Lente Lens [°]	Temp. colore Colour Temp. [K]	IRC CRI	Flusso lum. Lum. flux [lm]	Efficienza lum. Lum. effic. [lm / W]	Dimensioni / Dimensions [mm]			Cod. / Code LED	Cod. / Code LED DALI
						A (Ø)	B	ØA (Ø)		
5	55°	3000	>80	693	138	150	106	125	575300001	575300006
5	55°	4000	>80	727	145	150	106	125	575300011	575300016
5	55°	3000	>90	535	107	150	106	125	575300021	575300026
5	55°	4000	>90	660	132	150	106	125	575300031	575300036
7	55°	3000	>80	904	129	150	106	125	575300002	575300007
7	55°	4000	>80	949	135	150	106	125	575300012	575300017
7	55°	3000	>90	698	99	150	106	125	575300022	575300027
7	55°	4000	>90	862	123	150	106	125	575300032	575300037
9	55°	3000	>80	1106	122	150	106	125	575300003	575300008
9	55°	4000	>80	1160	128	150	106	125	575300013	575300018
9	55°	3000	>90	854	94	150	106	125	575300023	575300028
9	55°	4000	>90	1053	117	150	106	125	575300033	575300038
11	55°	3000	>80	1298	118	150	126	125	575300004	575300009
11	55°	4000	>80	1365	124	150	126	125	575300014	575300019
11	55°	3000	>90	1001	91	150	126	125	575300024	575300029
11	55°	4000	>90	1059	96	150	126	125	575300034	575300039
13	55°	3000	>80	1486	114	150	126	125	575300005	575300010
13	55°	4000	>80	1555	119	150	126	125	575300015	575300020
13	55°	3000	>90	1141	87	150	126	125	575300025	575300030
13	55°	4000	>90	1207	92	150	126	125	575300035	575300040

Point S/ADJ Frameless

55°

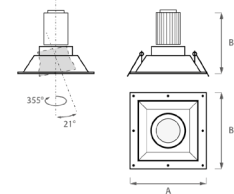
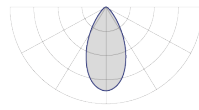

Potenza Power [W]	Lente Lens [°]	Temp. colore Colour Temp. [K]	IRC CRI	Flusso lum. Lum. flux [lm]	Efficienza lum. Lum. effic. [lm / W]	Dimensioni / Dimensions [mm]			Cod. / Code LED	Cod. / Code LED DALI
						A	B			
5	55°	3000	>80	693	138	150	106	120x120	572400008	572400013
5	55°	4000	>80	727	145	150	106	120x120	572400018	572400023
5	55°	3000	>90	535	107	150	106	120x120	572400028	572400033
5	55°	4000	>90	660	132	150	106	120x120	572400038	572400043
7	55°	3000	>80	904	129	150	106	120x120	572400009	572400014
7	55°	4000	>80	949	135	150	106	120x120	572400019	572400024
7	55°	3000	>90	698	99	150	106	120x120	572400029	572400034
7	55°	4000	>90	862	123	150	106	120x120	572400039	572400044
9	55°	3000	>80	1106	122	150	106	120x120	572400010	572400015
9	55°	4000	>80	1160	128	150	106	120x120	572400020	572400025
9	55°	3000	>90	854	94	150	106	120x120	572400030	572400035
9	55°	4000	>90	1053	117	150	106	120x120	572400040	572400045
11	55°	3000	>80	1298	118	150	126	120x120	572400011	572400016
11	55°	4000	>80	1365	124	150	126	120x120	572400021	572400026
11	55°	3000	>90	1001	91	150	126	120x120	572400031	572400036
11	55°	4000	>90	1059	96	150	126	120x120	572400041	572400046
13	55°	3000	>80	1486	114	150	126	120x120	572400012	572400017
13	55°	4000	>80	1555	119	150	126	120x120	572400022	572400027
13	55°	3000	>90	1141	87	150	126	120x120	572400032	572400037
13	55°	4000	>90	1207	92	150	126	120x120	572400042	572400047

Pearl ECO ADJ

IP20 IP 40/20



Caratteristiche tecniche

Technical Characteristics

Corpo	<ul style="list-style-type: none"> • Alluminio pressofuso 	Body	<ul style="list-style-type: none"> • Die-cast aluminium
Colore	<ul style="list-style-type: none"> ○ Bianco (RAL 9003) <p><u>Su richiesta:</u></p> <ul style="list-style-type: none"> ● Grigio ● Nero 	Colour	<ul style="list-style-type: none"> ○ White (RAL 9003) <p><u>Su richiesta:</u></p> <ul style="list-style-type: none"> ● Grey ● Black
Gruppo ottico	<ul style="list-style-type: none"> • Riflettore interno in alluminio metallizzato. • Fascio 60° <p><u>Su richiesta:</u></p> <ul style="list-style-type: none"> • Fascio 15° • Fascio 30° • Fascio 45° 	Optical group	<ul style="list-style-type: none"> • Internal reflector in metallic aluminium. • 60° beam angle <p><u>On request:</u></p> <ul style="list-style-type: none"> • 15° beam angle • 30° beam angle • 45° beam angle
Cablaggio	<ul style="list-style-type: none"> • LED ON/OFF con driver remoto incluso • LED DALI con driver remoto incluso <p><u>Su richiesta:</u></p> <ul style="list-style-type: none"> • Kit di EMERGENZA (autonomia 1/3 h) 	Wiring	<ul style="list-style-type: none"> • LED ON/OFF with included remote driver • LED DALI with included remote driver <p><u>On request:</u></p> <ul style="list-style-type: none"> • EMERGENCY kit (1/3 h autonomy)
Grado di protezione	<ul style="list-style-type: none"> • IP 20 <p><u>Su richiesta:</u></p> <ul style="list-style-type: none"> • IP 40/20 	Protection degree	<ul style="list-style-type: none"> • IP 20 <p><u>On request:</u></p> <ul style="list-style-type: none"> • IP 40/20

Sorgenti LED

LED sources

IRC	<ul style="list-style-type: none"> • >80 • >90 	CRI	<ul style="list-style-type: none"> • >80 • >90
Temp. colore	<ul style="list-style-type: none"> • 3000 K • 4000 K 	Colour Temp.	<ul style="list-style-type: none"> • 3000 K • 4000 K

Gruppi ottici

Optical groups

Riflettore interno in alluminio metallizzato. Apertura di fascio 60°.
Internal reflector in metallic aluminium. 60° beam angle.



Accessori (da ordinare separatamente)
Accessories (to be ordered separately)

IP
40/20



DIFFUSORE VETRO OPALE
OPAL GLASS DIFFUSER
Cod. / Code DF57550005VSB



DIFFUSORE VETRO TRASPARENTE
TRANSPARENT GLASS DIFFUSER
Cod. / Code DF57550005VTR

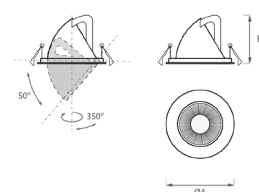
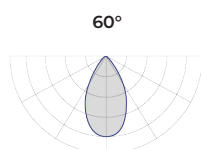

Potenza Power [W]	Lente Lens	Temp. colore Colour Temp. [K]	IRC CRI	Flusso lum. Lum. flux [lm]	Efficienza lum. Lum. effic. [lm / W]	Dimensioni / Dimensions [mm]			Cod. / Code LED	Cod. / Code LED DALI
						A (Ø)	B	ØA		
10	60°	3000	>80	1250	125	165	125	155	575500003	575500007
10	60°	4000	>80	1300	130	165	125	155	575500011	575500015
10	60°	3000	>90	1050	105	165	125	155	575500019	575500023
10	60°	4000	>90	1100	110	165	125	155	575500027	575500031
19	60°	3000	>80	2400	126	165	125	155	575500004	575500008
19	60°	4000	>80	2500	131	165	125	155	575500012	575500016
19	60°	3000	>90	2000	105	165	125	155	575500020	575500024
19	60°	4000	>90	2150	113	165	125	155	575500028	575500032
26	60°	3000	>80	3250	125	165	125	155	575500005	575500009
26	60°	4000	>80	3370	129	165	125	155	575500013	575500017
30	60°	3000	>90	3000	100	165	125	155	575500021	575500025
30	60°	4000	>90	3230	107	165	125	155	575500029	575500033
33	60°	3000	>80	4250	128	165	125	155	575500006	575500010
33	60°	4000	>80	4450	134	165	125	155	575500014	575500018
39	60°	3000	>90	4100	105	165	125	155	575500022	575500026
39	60°	4000	>90	4400	112	165	125	155	575500030	575500034

Twist

IP20

IP 40/20

UGR <19

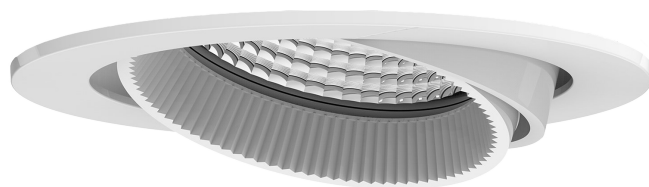

Caratteristiche tecniche

Technical Characteristics

Corpo	· Alluminio pressofuso	Body	· Die-cast aluminium
Colore	○ Bianco (RAL 9003) <u>Su richiesta:</u> ● Grigio ● Nero	Colour	○ White (RAL 9003) <u>Su richiesta:</u> ● Grey ● Black
Gruppo ottico	Riflettore interno in alluminio metallizzato. · Fascio 55° (Ø 150mm) · Fascio 60° (Ø 195mm) <u>Su richiesta:</u> · Fascio 20°; 30°; 45° (Ø 150mm) · Fascio 15°; 24°; 36°; 45° (Ø 195mm)	Optical group	Internal reflector in metallic aluminium. · 55° beam angle (Ø 150mm) · 60° beam angle (Ø 195mm) <u>On request:</u> · 20°; 30°; 45° beam angle (Ø 150mm) · 15°; 24°; 36°; 45° beam angle (Ø 195mm)
Cablaggio	· LED ON/OFF con driver remoto incluso · LED DALI con driver remoto incluso <u>Su richiesta:</u> · Kit di EMERGENZA (autonomia 1/3 h)	Wiring	· LED ON/OFF with included remote driver · LED DALI with included remote driver <u>On request:</u> · EMERGENCY kit (1/3 h autonomy)
Grado di protezione	· IP 20 <u>Su richiesta:</u> · IP 40/20	Protection degree	· IP 20 <u>On request:</u> · IP 40/20

Sorgenti LED

LED sources

IRC	· >80 · >90	CRI	· >80 · >90
Temp. colore	· 3000 K · 4000 K	Colour Temp.	· 3000 K · 4000 K

Gruppi ottici

Optical groups

Riflettore interno in alluminio sfaccettato. Ottica con emissione luminosa controllata con valori di luminanza <15000 ca/m² per angoli di emissione superiori a 65° su tutti i piani (UGR<19), idonea per l'installazione in presenza di videoterminali in conformità con le norme UNI EN 12464-1. Apertura di fascio 55° (Ø A=150 mm) e 60° (Ø A=195mm).
Internal reflector in multifaceted aluminium. Controlled light emission optics with luminance values <15000 ca/m² for emission angles >65° (UGR<19), suitable for installation in workplaces with the use of videoterminals according to UNI EN 12464-1 standards. 55° (Ø A=150 mm) and 60° (Ø A=195mm) beam angles.

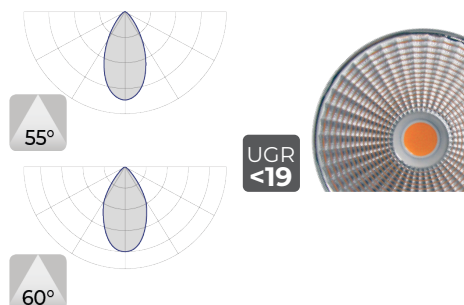

Accessori (da ordinare separatamente)
Accessories (to be ordered separately)



DIFFUSORE VETRO OPALE
OPAL GLASS DIFFUSER
Cod. / Code DF5758000xVSB

- **3** : Ø 150 mm
- **4** : Ø 195 mm



DIFFUSORE VETRO TRASPARENTE
TRANSPARENT GLASS DIFFUSER
Cod. / Code DF5758000xVTR

- **3** : Ø 150 mm
- **4** : Ø 195 mm

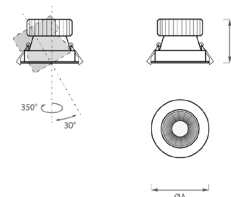
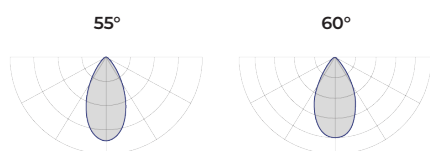

Potenza Power [W]	Lente Lens	Temp. colore Colour Temp. [K]	IRC CRI	Flusso lum. Lum. flux [lm]	Efficienza lum. Lum. effic. [lm / W]	Dimensioni / Dimensions [mm]			Cod. / Code LED	Cod. / Code LED DALI
						A (Ø)	B	ØA		
10	55°	3000	>80	1250	125	150	111	140	575800001	575800004
10	55°	4000	>80	1300	130	150	111	140	575800007	575800010
10	55°	3000	>90	1050	105	150	111	140	575800029	575800032
10	55°	4000	>90	1100	110	150	111	140	575800035	575800038
10	60°	3000	>80	1250	125	195	135	185	575800013	575800017
10	60°	4000	>80	1300	130	195	135	185	575800021	575800025
10	60°	3000	>90	1050	105	195	135	185	575800041	575800045
10	60°	4000	>90	1100	110	195	135	185	575800049	575800053
19	55°	3000	>80	2400	126	150	111	140	575800002	575800005
19	55°	4000	>80	2500	131	150	111	140	575800008	575800011
19	55°	3000	>90	2000	105	150	111	140	575800030	575800033
19	55°	4000	>90	2150	113	150	111	140	575800036	575800039
19	60°	3000	>80	2400	126	195	135	185	575800014	575800018
19	60°	4000	>80	2500	131	195	135	185	575800022	575800026
19	60°	3000	>90	2000	105	195	135	185	575800042	575800046
19	60°	4000	>90	2150	113	195	135	185	575800050	575800054
26	55°	3000	>80	3250	125	150	111	140	575800003	575800006
26	55°	4000	>80	3370	129	150	111	140	575800009	575800012
26	60°	3000	>80	3250	125	195	135	185	575800015	575800019
26	60°	4000	>80	3370	129	195	135	185	575800023	575800027
30	55°	3000	>90	3000	100	150	111	140	575800031	575800034
30	55°	4000	>90	3230	107	150	111	140	575800037	575800040
30	60°	3000	>90	3000	100	195	135	185	575800043	575800047
30	60°	4000	>90	3230	107	195	135	185	575800051	575800055
33	60°	3000	>80	4250	128	195	135	185	575800016	575800020
33	60°	4000	>80	4450	134	195	135	185	575800024	575800028
39	60°	3000	>90	4100	105	195	135	185	575800044	575800048
39	60°	4000	>90	4400	112	195	135	185	575800052	575800056

1) Il flusso effettivo potrebbe avere una tolleranza del ±10%. / The effective flux could have a tolerance of ±10%

Spy

IP20

IP
40/20



Caratteristiche tecniche

Technical Characteristics

Corpo	<ul style="list-style-type: none"> • Alluminio pressofuso 	Body	<ul style="list-style-type: none"> • Die-cast aluminium
Colore	<ul style="list-style-type: none"> ○ Bianco (RAL 9003) <p><u>Su richiesta:</u></p> <ul style="list-style-type: none"> ● Grigio ● Nero 	Colour	<ul style="list-style-type: none"> ○ White (RAL 9003) <p><u>Su richiesta:</u></p> <ul style="list-style-type: none"> ● Grey ● Black
Gruppo ottico	<p>Riflettore interno in alluminio metallizzato. Fascio 60°</p> <p><u>Su richiesta:</u></p> <ul style="list-style-type: none"> • Fascio 15° • Fascio 30° • Fascio 45° 	Optical group	<p>Internal reflector in metallic aluminium. 60° beam angle</p> <p><u>On request:</u></p> <ul style="list-style-type: none"> • 15° beam angle • 30° beam angle • 45° beam angle
Cablaggio	<ul style="list-style-type: none"> • LED ON/OFF con driver remoto incluso • LED DALI con driver remoto incluso <p><u>Su richiesta:</u></p> <ul style="list-style-type: none"> • Kit di EMERGENZA (autonomia 1/3 h) 	Wiring	<ul style="list-style-type: none"> • LED ON/OFF with included remote driver • LED DALI with included remote driver <p><u>On request:</u></p> <ul style="list-style-type: none"> • EMERGENCY kit (1/3 h autonomy)
Grado di protezione	<ul style="list-style-type: none"> • IP 20 <p><u>Su richiesta:</u></p> <ul style="list-style-type: none"> • IP 40/20 	Protection degree	<ul style="list-style-type: none"> • IP 20 <p><u>On request:</u></p> <ul style="list-style-type: none"> • IP 40/20

Sorgenti LED

LED sources

IRC	<ul style="list-style-type: none"> • >80 • >90 	CRI	<ul style="list-style-type: none"> • >80 • >90
Temp. colore	<ul style="list-style-type: none"> • 3000 K • 4000 K 	Colour Temp.	<ul style="list-style-type: none"> • 3000 K • 4000 K

Gruppi ottici Optical groups

Riflettore interno in alluminio metallizzato. Apertura di fascio 60°.
Internal reflector in metallic aluminium. 60° beam angle.

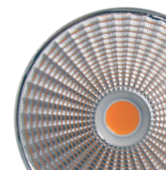
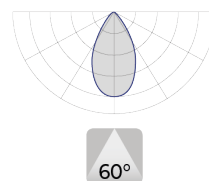

Accessori (da ordinare separatamente) Accessories (to be ordered separately)

IP
40/20



DIFFUSORE VETRO OPALE
OPAL GLASS DIFFUSER
Cod. / Code DF57570002VSB



DIFFUSORE VETRO TRASPARENTE
TRANSPARENT GLASS DIFFUSER
Cod. / Code DF57570002VTR

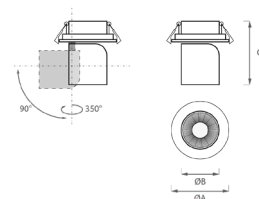
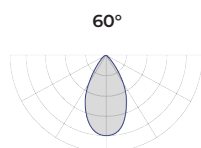

Potenza Power [W]	Lente Lens	Temp. colore Colour Temp. [K]	IRC CRI	Flusso lum. Lum. flux [lm]	Efficienza lum. Lum. effic. [lm / W]	Dimensioni / Dimensions [mm]				Cod. / Code LED	Cod. / Code LED DALI
						A (Ø)	B (Ø)	C	(Ø)		
10	60°	3000	>80	1250	125	160	106	177	145	575700001	575700004
10	60°	4000	>80	1300	130	160	106	177	145	575700007	575700010
10	60°	3000	>90	1050	105	160	106	177	145	575700013	575700016
10	60°	4000	>90	1110	111	160	106	177	145	575700019	575700022
19	60°	3000	>80	2400	126	160	106	177	145	575700002	575700005
19	60°	4000	>80	2500	131	160	106	177	145	575700008	575700011
19	60°	3000	>90	2000	105	160	106	177	145	575700014	575700017
19	60°	4000	>90	2150	113	160	106	177	145	575700020	575700023
26	60°	3000	>80	3250	125	160	106	177	145	575700003	575700006
26	60°	4000	>80	3370	129	160	106	177	145	575700009	575700012
30	60°	3000	>90	3000	100	160	106	177	145	575700015	575700018
30	60°	4000	>90	3230	107	160	106	177	145	575700021	575700024

1) Il flusso effettivo potrebbe avere una tolleranza del ±10%. / The effective flux could have a tolerance of ±10%

SD016

IP20 IP44 UGR <19



Caratteristiche tecniche

Technical Characteristics

Corpo	· Alluminio pressofuso	Body	· Die-cast aluminium
Colore	○ Bianco (RAL 9003) <u>Su richiesta:</u> ● Grigio ● Nero	Colour	○ White (RAL 9003) <u>Su richiesta:</u> ● Grey ● Black
Gruppo ottico	Riflettore interno in alluminio sfaccettato. · Fascio 55° (Ø A=160mm) · Fascio 60° (Ø A=220mm) <u>Su richiesta:</u> · Fascio 20°; 30°; 45° (Ø A=160mm) · Fascio 15°; 30°; 45° (Ø A=220mm)	Optical group	Internal reflector in metallic aluminium. · 55° beam angle (Ø A=160mm) · 60° beam angle (Ø A=220mm) <u>On request:</u> · 15°; 30°; 45° beam angles (Ø A=160mm) · 15°; 30°; 45° beam angles (Ø A=220mm)
Cablaggio	· LED ON/OFF con driver remoto incluso · LED DALI con driver remoto incluso	Wiring	· LED ON/OFF with included remote driver · LED DALI with included remote driver
Grado IP	· IP 44	Protection degree	· IP 44

Sorgenti LED

LED sources

IRC	· >80 · >90	CRI	· >80 · >90
Temp. colore	· 3000 K · 4000 K	Colour Temp.	· 3000 K · 4000 K

Gruppi ottici

Optical groups

Riflettore interno in alluminio metallizzato. Apertura di fascio 55° (Ø A=160mm) e 60° (Ø A= 220mm).
Internal reflector in metallic aluminium. 55° (Ø A=160mm) and 60° (Ø A= 220mm) beam angle.

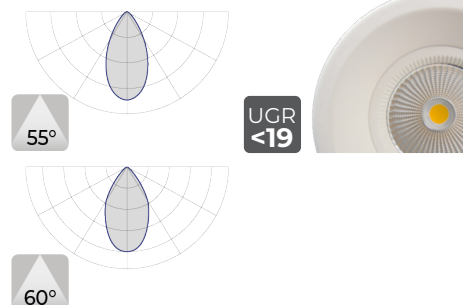

Accessori (da ordinare separatamente)
Accessories (to be ordered separately)



DIFFUSORE VETRO OPALE
OPAL GLASS DIFFUSER
 Cod. / Code DF5601000XVSB

- **3** : Ø 160 mm
- **4** : Ø 220 mm



DIFFUSORE VETRO TRASPARENTE
TRANSPARENT GLASS DIFFUSER
 Cod. / Code DF5601000XVTR

- **3** : Ø 160 mm
- **4** : Ø 220 mm

Sospensione e Plafone / Suspension and ceiling



KIT SOSPENSIONE
SUSPENSION KIT

Cod. / Code KS800
 Rosone tondo elettrificato di colore bianco con morsettiera e cavo di alimentazione
Electrified round ceiling rose white coloured with connection terminal block and power cable

L= 3000 mm
 Ø 0,75 mmq

- **0** : LED
- **4** : LED DALI



KIT PLAFONE
CEILING INSTALLATION KIT

Cod. / Code KMP560123000X
 Staffa di fissaggio a plafone.
Fixing bracket for ceiling installation.

- **5** : Ø 160mm
- **6** : Ø 220mm

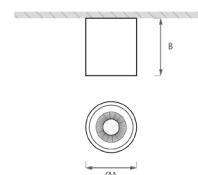
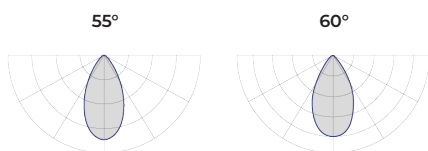

Potenza Power [W]	Lente Lens	Temp. colore Colour Temp. [K]	IRC CRI	Flusso lum. Lum. flux [lm]	Efficienza lum. Lum. effic. [lm / W]	Dimensioni / Dimensions [mm]		Cod. / Code LED	Cod. / Code LED DALI
						A (Ø)	B		
10	55°	3000	>80	1250	125	160	180	560100035	560100036
10	55°	4000	>80	1300	130	160	180	560100037	560100038
10	55°	3000	>90	1050	105	160	180	560100043	560100044
10	55°	4000	>90	1100	110	160	180	560100047	560100048
10	60°	3000	>80	1250	125	220	240	560100006	560100020
10	60°	4000	>80	1300	130	220	240	560100011	560100021
10	60°	3000	>90	1050	105	220	240	560100050	560100054
10	60°	4000	>90	1100	110	220	240	560100058	560100062
19	55°	3000	>80	2400	126	160	180	560100039	560100040
19	55°	4000	>80	2500	131	160	180	560100041	560100042
19	55°	3000	>90	2000	105	160	180	560100045	560100046
19	55°	4000	>90	2150	113	160	180	560100034	560100049
19	60°	3000	>80	2400	126	220	240	560100007	560100022
19	60°	4000	>80	2500	131	220	240	560100012	560100023
19	60°	3000	>90	2000	105	220	240	560100051	560100055
19	60°	4000	>90	2150	113	220	240	560100059	560100031
26	60°	3000	>80	3250	125	220	240	560100008	560100024
26	60°	4000	>80	3370	129	220	240	560100013	560100025
30	60°	3000	>90	3000	100	220	240	560100052	560100056
30	60°	4000	>90	3220	107	220	240	560100060	560100063
33	60°	3000	>80	4250	128	220	240	560100009	560100026
33	60°	4000	>80	4450	134	220	240	560100014	560100027
39	60°	3000	>90	4100	105	220	240	560100053	560100057
39	60°	4000	>90	4400	112	220	240	560100061	560100064

1) Il flusso effettivo potrebbe avere una tolleranza del ±10%. / The effective flux could have a tolerance of ±10%

Mini

IP44



Mini R



Mini Q



Caratteristiche tecniche

Technical Characteristics

Corpo · Alluminio e materiale termoplastico

Colore ○ Bianco

Gruppo ottico · MOT - metacrilato opale, fascio 110°

Cablaggio · LED ON/OFF con driver integrato

Grado di protezione · IP 44

Body · Aluminium and thermoplastic material

Colour ○ White

Optical group · MOT - opal methacrylate, 110° beam angle

Wiring · LED ON/OFF with integrated driver

Protection degree · IP 44

Sorgenti LED

LED sources

IRC · >80

Temp. colore · 3000 K
· 4000 K

CRI · >80

Colour Temp. · 3000 K
· 4000 K

Gruppi ottici

Optical groups

MOT

Diffusore in metacrilato opale ad alta trasmittanza, ideale per una distribuzione uniforme.

Diffuser in opal methacrylate with high transmittance, ideal for uniform distribution.

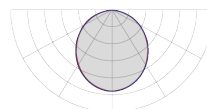

Mini R

MOT

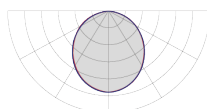

Potenza Power [W]	Temp. colore Colour Temp. [K]	IRC CRI	Flusso lum. Lum. flux [lm]	Efficienza lum. Lum. effic. [lm / W]	Dimensioni / Dimensions [mm]		Cod. / Code LED
					A (∅)	B	
6	3000	>80	350	58	128	39	573400009
6	4000	>80	390	65	128	39	573400008
12	3000	>80	780	65	182	39	573400011
12	4000	>80	850	70	182	39	573400010
18	3000	>80	1300	72	232	39	573400012
18	4000	>80	1450	80	232	39	573400007
20	3000	>80	1500	75	252	39	573400014
20	4000	>80	1600	80	252	39	573400013

Mini Q



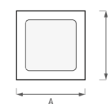
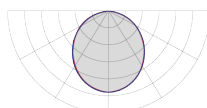













MOT



Potenza Power [W]	Temp. colore Colour Temp. [K]	IRC CRI	Flusso lum. Lum. flux [lm]	Efficienza lum. Lum. effic. [lm / W]	Dimensioni / Dimensions [mm]		Cod. / Code LED
					A	B	
6	3000	>80	350	58	128	39	573300004
6	4000	>80	390	65	128	39	573300005
12	3000	>80	780	65	181	39	573300006
12	4000	>80	850	70	181	39	573300007
18	3000	>80	1300	72	231	39	573300008
18	4000	>80	1450	80	231	39	573300009

PITTOGRAMMI

Pictograms

-  **Apparecchio da installare in ambienti interni**
Device for indoor installation
-  **Apparecchio da installare in ambienti esterni**
Device for outdoor installation
-  **Apparecchio da installare ad incasso**
Device for recessed installation
-  **Apparecchio da installare a soffitto, a plafone**
Device suitable for ceiling installation, surface mounted
-  **Apparecchio da installare a parete**
Device for wall installation
-  **Apparecchio da installare a sospensione**
Device for suspended installation
-  **Apparecchio da terra**
Floor device
-  **Apparecchio da installare ad angolo, effetto wall-washer**
Device for angle installation, wall-washer effect
-  **Apparecchio installabile in linea continua**
Suitable for continuous row installation
-  **Dimensioni foro di incasso**
Recessed hole size
-  **L'apparecchio è adatto ad essere installato in ambienti medici**
The device is suitable to be installed in medical environments
-  **Apparecchio per controsoffitto calpestabile**
Walkable false ceiling device
-  **L'apparecchio emette solo luce diretta**
The device emits direct light only
-  **L'apparecchio emette solo luce indiretta**
The device emits indirect light only
-  **L'apparecchio emette contemporaneamente luce diretta e indiretta**
The device emits simultaneously direct and indirect light
-  **L'apparecchio emette luce a 180°**
The device emits a 180° beam of light
-  **L'apparecchio emette luce a 270°**
The device emits a 270° beam of light
-  **L'apparecchio emette luce asimmetrica (effetto wall-washer)**
The device emits asymmetric light (wall-washer effect)
-  **L'apparecchio emette luce ai lati**
The device emits side light
-  **L'apparecchio emette con apertura di fascio pari a gradi "n"**
The device emits with "n" beam angle

-  **Apparecchio disponibile con circuito LED-RGB**
The device is available with RGB-LED circuit
-  **Apparecchio disponibile con circuito Bianco Dinamico**
The device is available with Tunable White circuit
-  **Controllo dell'abbagliamento (Unified Glare Rating)**
Glare control (Unified Glare Rating)
-  **Il prodotto ha superato la prova del fuoco, risultando perfettamente resistente ad un'esposizione al fuoco di 120 minuti, come stabilito dalla normativa europea EN 13501-2**
The device has passed the fire test resulting resistant to a fire exposure of about 120 minutes, as established from the European regulation EN 13501-2
-  **Adatto a temperature di esercizio estreme**
Suitable for extreme operating temperature
-  **Il prodotto rispetta le direttive di compatibilità elettromagnetica stabilite dalla Comunità Europea 2014/30/UE e 2014/35/UE**
The device respects the electromagnetic compatibility directives, established by the European Community in the 2014/30/UE and 2014/35/UE regulations
-  **(Restriction of Hazardous Substances) Per la realizzazione di questo prodotto non sono stati utilizzati piombo, cadmio, cromo esavalente, bifenili polibromurati, eteri di difenile polibromurati. Il prodotto risulta quindi conforme alla direttiva comunitaria 2011/65/C**
(Restriction of Hazardous Substances). To realize this device we haven't used: lead, cadmium, hexavalent chromium, polybrominated biphenyls and polybrominated ethers. This means that the product responds to the European Directive 2011/65/C
-  **I LED installati all'interno del prodotto sono esenti dall'emissione di raggi UV e IR**
LEDs inside the device are free from UV and IR rays emission
-  **Classe di isolamento I**
Insulation Class I
-  **Alimentatore in doppio isolamento**
Double insulation driver
-  **Classe di isolamento III**
Insulation Class III
-  **Bassissima tensione di sicurezza grazie all'uso di alimentatori con doppio isolamento di sicurezza**
A very low voltage tension is obtained using ballasts with double safety insulation
-  **I LED utilizzati nei prodotti illuminotecnici appartengono a diversi gruppi di rischio, come stabilito dalla normativa EN62471. Il gruppo 0 include i LED che non costituiscono alcun rischio per la salute dell'uomo, il gruppo 1 indica un rischio basso, il gruppo 2 un rischio moderato e il gruppo 3 un rischio elevato**
LED sources used in lighting devices become from different risk groups, as established from the EN62471 regulation. The 0 risk group includes LEDs without risks for the human being, group 1 means there is a medium risk, group 2 a moderate risk and group 3 means there is a high risk for the human health



GRADO DI PROTEZIONE contro impatti meccanici esterni
PROTECTION DEGREE against external mechanical impacts

n	JOULES	DESCRIZIONE <i>Description</i>
7	2	Protetto contro un oggetto di 500 g lanciato da 40 cm di altezza <i>Protected against a 500 g object dropped from 40 cm in height</i>
10	20	Protetto contro un oggetto di 5 kg lanciato da 40 cm di altezza <i>Protected against a 5 kg object dropped from 40 cm in height</i>



GRADO DI PROTEZIONE da corpi solidi estranei e acqua
PROTECTION GRADE against foreign solid objects and water

La norma EN 60529 fornisce un sistema di classificazione dei gradi di protezione degli involucri delle apparecchiature elettriche. Il grado di protezione è indicato dalla sigla IP (Protezione Internazionale) seguita da:

- Prima cifra (da 0 a 6 o lettera X)
- Seconda cifra (da 0 a 6 o lettera Y)

The EN 60529 rule gives a classification system of the protection grade of the electric equipment covers. The protection grade has the abbreviation of IP (International Protection) followed by:

- First digit (from 0 to 6 or letter X)
- Second digit (from 0 to 6 or letter Y)

	PRIMA CIFRA (X) Protezione da corpi solidi estranei: <i>FIRST DIGIT (X)</i> <i>Solid particle protection:</i>	SECONDA CIFRA (Y) Protezione dall'ingresso di liquidi: <i>SECOND DIGIT (Y)</i> <i>Liquid ingress protection:</i>
0	Nessuna protezione <i>None</i>	Nessuna protezione <i>None</i>
2	Superiori a 12,5mm di diametro <i>Diameter bigger than 12,5mm</i>	Gocce d'acqua con inclinazione max dell'involucro di 15° <i>Dripping water when tilted at 15°</i>
4	Superiore a 1mm di diametro <i>Diameter bigger than 1mm</i>	Spruzzi d'acqua <i>Splashing of water</i>
5	Parzialmente protetto contro la polvere <i>Partial protection against dust</i>	Getti d'acqua <i>Water jets</i>
6	Totalmente protetto contro la polvere <i>Total protection against dust</i>	Getti d'acqua potenti <i>Powerful water jets</i>

CONDIZIONI GENERALI DI VENDITA

General sale conditions

PRINCIPI GENERALI GENERAL PRINCIPLES

1. Il presente catalogo annulla e sostituisce ogni edizione precedente.
 2. ATENA LUX si riserva la facoltà di apportare senza preavviso modifiche nei prodotti per il miglioramento continuo degli stessi. Per tale perfezionamento gli apparecchi forniti potranno differire nei dettagli e nelle misure, nelle dotazioni e negli accessori. Le descrizioni riportate nei cataloghi non sono quindi vincolanti.
 3. ATENA LUX opera in linea con i principi riportati nel proprio Codice Etico, nel rispetto di tutti gli stakeholder coinvolti nell'attività di produzione, commerciale e marketing. Il codice etico è consultabile al sito www.atenalux.com/news/codice-etico.html
 4. L'acquirente non potrà registrare e/o utilizzare nomi simili o identici al marchio ATENA LUX, se non dopo espressa e preventiva autorizzazione scritta.
1. *This catalog cancels and replaces any previous edition.*
 2. *ATENA LUX reserves the right to make changes in the products without prior notice for their continuous improvement. For this improvement, the devices supplied may differ in details and sizes, in the equipment and accessories. The descriptions given in the catalogs are therefore not binding.*
 3. *ATENA LUX operates in line with the principles set out in its Code of Conduct, in compliance with all stakeholders involved in production, sales and marketing. The code of ethics is available at www.atenalux.com/news/*
 4. *The buyer may not register and / or use names similar or identical to the ATENA LUX brand, unless after express and prior written authorization.*

ORDINI ORDERS

1. Con il conferimento dell'ordine e/o con la presa in carico dei materiali si intendono integralmente accettate dall'acquirente le presenti condizioni di vendita.
 2. Le presenti condizioni di vendita sono da ritenersi prevalenti rispetto a qualsiasi altra. La loro integrale accettazione da parte dell'acquirente si perfeziona al momento della conferma d'ordine.
 3. Gli ordini effettuati dall'acquirente dovranno pervenire solo in forma scritta, non si accettano ordini confermati diversamente. Tutti gli ordini devono essere sottoscritti da persona autorizzata ad impegnare l'acquirente. In ogni caso l'esistenza del potere di rappresentanza dell'acquirente da parte del sottoscrittore si presume a favore di ATENA LUX.
 4. Gli ordini saranno evasi secondo la disponibilità delle materie e le spedizioni potranno essere fatte anche parzialmente.
 5. Verrà dato corso a ordini che prevedono materiale in esecuzione speciale, solo previa accettazione del disegno tecnico da parte del committente
 6. ATENA LUX si riserva il diritto di accettare o meno l'ordine e di sospendere le consegne in caso di ritardi nei pagamenti o situazioni di insolvenza da parte del compratore.
 7. Qualsiasi circostanza indipendente dalla volontà delle parti che sopravvenga dopo il perfezionamento del contratto di vendita e ne impedisca la ragionevole esecuzione, viene considerata causa di esonero.
1. *By placing the order and / or taking charge of the materials, these conditions of sale are fully accepted by the buyer.*
 2. *These conditions of sale are to be considered prevailing over any other. Their full acceptance by the buyer is perfected at the time of order confirmation.*
 3. *Orders placed by the buyer must only be received in writing, otherwise confirmed orders are not accepted. All orders must be signed by a person authorized to bind the buyer. In any case, the existence of the buyer's power of representation by the subscriber is presumed in favor of ATENA LUX.*
 4. *Orders will be processed according to the availability of materials and shipments can be made even partially.*
 5. *Orders involving material in special execution will be processed only upon acceptance of the technical drawing by the customer.*
 6. *ATENA LUX reserves the right to accept or reject the order and to suspend deliveries in the event of late payments or insolvency on the part of the buyer.*
 7. *Any circumstance beyond the control of the parties that occurs after the conclusion of the sales contract and prevents its reasonable execution, is considered a cause for exemption.*

PREZZI E QUOTAZIONI PRICES AND QUOTATIONS

1. I prezzi indicati nei listini prezzi sono da intendersi al netto di IVA.
 2. Le quotazioni inserite in offerta sono valide per un periodo di 30 giorni, salvo specifici accordi tra le parti.
 3. ATENA LUX si riserva la facoltà di modificare la quotazione indicata in offerta, dandone comunicazione scritta al cliente, anche prima dello scadere del periodo di validità della quotazione stessa, nei seguenti casi:
 - a. In caso di aumenti di costo dovuti a fattori non imputabili ad ATENA LUX (per esempio aumenti di costo delle materie prime, fluttuazione dei tassi di cambio, ecc.);
 - b. Nel caso in cui l'acquirente modifichi la data di consegna, le quantità o i tipi di prodotto ordinati;
 - c. Nel caso in cui l'acquirente ritardi nel fornire eventuali informazioni o istruzioni necessarie al completamento della fornitura in oggetto.
1. *The prices indicated in the price lists are to be understood net of VAT.*
 2. *The quotations included in the offer are valid for a period of 30 days, except for specific agreements between the parties.*
 3. *ATENA LUX reserves the right to modify the quotation indicated in the offer, by giving written notice to the customer, even before the expiry of the period of validity of the quotation itself, in the following cases:*
 - a. *In the event of cost increases due to factors not attributable to ATENA LUX (for example, increases in the cost of raw materials, fluctuations in exchange rates, etc.);*
 - b. *In the event that the buyer changes the delivery date, the quantities or types of products ordered;*
 - c. *In the event that the buyer delays in providing any information or instructions necessary to complete the production of the goods ordered.*

SPEDIZIONI SHIPMENTS

1. I termini di consegna indicati nelle conferme d'ordine hanno valore indicativo e in caso di ritardo non danno diritto a indennizzi o risarcimenti di alcun genere.
 2. Fatto salvo esplicito accordo contrario, le spese di spedizione sono sempre a carico dell'acquirente.
 3. Il materiale ordinato si ritira presso lo stabilimento di ATENA LUX, situato in Via Giai 33, 30020 Gruaro (VE).
 4. In caso di ritardi dovuti a situazioni di contingenza, per quanto già in corso di produzione l'acquirente non potrà pretendere annullamenti parziali o totali del materiale ordinato, tantomeno avanzare richieste di risarcimento ad alcun titolo per eventuali danni causati a lui stesso o a terzi.
 5. Le campionature sono sempre fornite in porto assegnato e fatturate.
 6. La merce viaggia a rischio e pericolo dell'acquirente con qualsiasi mezzo spedita, sia in porto franco che assegnato.
 7. Le spese relative all'emissione di certificati di origine, legalizzazione di documenti e in generale tutti i documenti espressamente richiesti ad accompagnare la merce, ad esclusione di fatture o documenti di trasporto, restano a carico del compratore se non diversamente specificato per iscritto nelle conferme d'ordine. Licenze di importazione, leggi, regolamenti e procedure doganali applicabili nel Paese di destinazione devono essere verificati dall'acquirente senza alcuna responsabilità sottintesa da parte di ATENA LUX.
1. *The delivery terms indicated in the order confirmations are indicative and do not give the right to indemnity or compensation in case of delay.*
 2. *Unless explicitly agreed to the contrary, shipping costs are always borne by the buyer.*
 3. *The ordered material is collected at the ATENA LUX factory, located in Via Giai 33, 30020 Gruaro (VE).*
 4. *In the event of delays due to contingency situations, even though production is already underway, the purchaser cannot claim partial or total cancellation of the ordered material, nor can he make any claims for compensation for any damage caused to himself or to third parties.*
 5. *Samples are always delivered EX-WORKS incoterms and invoiced.*
 6. *The goods are shipped at the buyer's expenses and risks by any means shipped, both carriage paid and assigned.*
 7. *The costs relating to the issue of certificates of origin, legalization of documents and in general all documents expressly requested to accompany the goods, with the exception of invoices or transport documents, remain the responsibility of the buyer unless otherwise specified in writing in the order confirmations. Import licenses, laws, regulations and customs procedures applicable in the country of destination must be verified by the buyer without any implied liability on the part of ATENA LUX.*

RECLAMI E RESI COMPLAINTS AND RETURNS

1. Trascorsi otto giorni dal ricevimento delle merci non si accettano reclami. Nessun reclamo potrà essere in ogni caso preso in considerazione, neppure in sede giudiziaria, qualora non si sia verificato il regolare pagamento della merce alla quale il reclamo fa riferimento. I prodotti ordinati sono sempre verificati in fase di preparazione carico, sia nelle quantità, sia nelle codifiche, al fine di una corretta corrispondenza rispetto all'ordine confermato dall'acquirente. Resta tuttavia a carico dell'acquirente la verifica della corrispondenza e delle caratteristiche tecniche del materiale ordinato rispetto alle conferme d'ordine ricevute, queste ultime sono da ritenersi valide solo se emesse e ricevute direttamente da ATENA LUX.
 2. L'acquirente ha l'obbligo di verificare la quantità e lo stato della merce al momento della consegna e apporre eventuale riserva di verifica sul DDT di riferimento contestualmente allo scarico. Nel caso in cui dovessero verificarsi mancanze, manomissioni o danneggiamenti della merce l'acquirente dovrà apporre riserve scritte al trasportatore all'atto della ricezione della stessa al fine di avere diritto a richiedere eventuali riparazioni, sostituzioni o integrazioni, soggette comunque al giudizio di ATENA LUX. Qualora tali riserve non venissero apposte, l'acquirente perderà automaticamente il diritto alla sostituzione o riparazione dei prodotti.
 3. Non si accettano richieste di reso per prodotti in esecuzione speciale o per errori di ordinazione. Non si accettano in ogni caso resi nel mese di Dicembre
 4. Eventuali resi di merce dovranno essere preventivamente e direttamente autorizzati da ATENA LUX e restituiti in porto franco, intatti, nel proprio imballo originale presso la sede di via Giai n. 33, 30020 - Gruaro (VE) - ITALIA.
 5. Eventuali richieste di reso vanno effettuate per iscritto, nei tempi stabiliti dalla legge, giustificate da motivi plausibili e accompagnate da una descrizione dettagliata della motivazione per cui viene richiesto il reso. Il materiale reso verrà comunque accettato con riserva di verifica ed eventualmente accreditato solo se ricevuto intatto, con un deprezzamento minimo pari al 10% fino a un massimo valutato insindacabilmente da ATENA LUX. Tali resi devono pervenire accompagnati da relativo documento di trasporto sul quale dovranno comparire gli estremi della fattura relativa alla fornitura di ogni singolo prodotto e la causale del reso.
1. *After eight days from the receipt of the goods, no complaints will be accepted. No complaint can in any case be taken into consideration, not even in court, if the regular payment of the goods to which the complaint refers has not occurred. The ordered products are always checked during the loading preparation phase, both in quantity and in coding, in order to ensure a correct correspondence with the order confirmed by the buyer. However, it remains the responsibility of the buyer to check the correspondence and technical characteristics of the ordered material with respect to the order confirmations received, the latter are to be considered valid only if issued and received directly by ATENA LUX.*
 2. *The buyer is obliged to check the quantity and condition of the goods at the time of delivery and to place any verification reserve on the reference transport document at the same time as unloading. In the event that any lack, tampering or damage to the goods occurs, the buyer must make written reservations to the carrier upon receipt of the same in order to be entitled to request any repairs, replacements or additions, subject in any case to the judgment of ATENA LUX. If these reservations are not affixed, the buyer will automatically lose the right to replace or repair the products.*
 3. *We do not accept requests for returns for products in special execution or for order mistakes. In any case, returns are not accepted in the month of December.*
 4. *Any returns of goods must be previously and directly authorized by ATENA LUX and returned carriage free, intact, in their original packaging at the headquarters in via Giai n. 33, 30020 - Gruaro (VE) - ITALY.*
 5. *Any return requests must be made in writing, within the time limits established by law, justified by plausible reasons and accompanied by a detailed description of the reason for which the return is requested. The returned material will in any case be accepted subject to verification and possibly credited only if received intact, with a minimum depreciation of 10% up to a maximum assessed unquestionably by ATENA LUX. These returns must be received accompanied by the relative transport document on which the details of the invoice relating to the supply of each individual product and the reason for the return must appear.*

PAGAMENTI PAYMENTS

1. I pagamenti devono essere eseguiti esclusivamente su conto corrente bancario comunicato da ATENA LUX, presso la sede o a mani di incaricati ATENA LUX provvisti di mandato scritto specifico. I pagamenti devono essere effettuati in Euro, per l'importo totale concordato in fattura. Eventuali costi aggiuntivi, come per esempio spese bancarie o qualsiasi altra spesa non preventivamente concordata, restano a carico dell'acquirente.
 2. Per nessun motivo e a nessun titolo l'acquirente può differire i pagamenti oltre le scadenze pattuite, in seguito a ritardi nella consegna di materiali o a contestazioni di qualsiasi natura. In caso di ritardi nei pagamenti rispetto alle scadenze pattuite saranno dovuti gli interessi di mora e addebitate eventuali spese, anche legali, per il recupero del credito.
 3. La vendita è da ritenersi eseguita con patto di riservato dominio: ciò implica che la proprietà del materiale resta di ATENA LUX fino a che l'acquirente non abbia corrisposto l'intera somma pattuita.
1. *Payments must be made exclusively to a bank account communicated by ATENA LUX, at the headquarters or in the hands of ATENA LUX agents with a specific written mandate. Payments must be made in Euros, for the total amount agreed in the invoice. Any additional costs, such as bank charges or any other expenses not previously agreed, remain the responsibility of the buyer.*
 2. *For no reason and for no reason the buyer may defer payments beyond the agreed deadlines, following delays in the delivery of materials or disputes of any kind. In the event of late payments with respect to the agreed deadlines, interest on arrears will be due and any expenses, including legal costs, will be charged for credit recovery.*
 3. *The sale is to be considered carried out with retention of title: this implies that the ownership of the material remains with ATENA LUX until the buyer has paid the entire agreed sum.*

GARANZIA WARRANTY

1. Gli acquirenti sono responsabili per la scelta degli articoli in relazione alle loro caratteristiche e all'uso a cui sono destinati. Si raccomanda pertanto di effettuare il montaggio e l'utilizzo secondo la regola dell'arte e della buona tecnica, consultando e conservando i fogli d'istruzione allegati ad ogni prodotto.
 2. La garanzia sarà fornita per la durata di 12 mesi dalla data di emissione della fattura di vendita e si limita a pezzi ritenuti difettosi all'origine o inservibili a causa di difetti di materiale o difetti di costruzione da parte di ATENA LUX.
 3. Eccezione fatta per alcuni prodotti specifici, è possibile richiedere un'estensione della garanzia a 5 anni dalla data della fattura, presentandone la richiesta in fase di definizione dell'ordine e comunque nei modi e nei tempi stabiliti nell'apposito modulo di estensione garanzia, scaricabile al sito www.atenalux.com. La validità dell'estensione della garanzia sarà valutata a insindacabile giudizio di ATENA LUX.
 4. La garanzia NON copre: tutte le eventuali spese accessorie scaturite a seguito alla riparazione del vizio/difetto (per es. quelle relative alla riparazione di terzi, al montaggio e allo smontaggio, al trasporto del prodotto affetto da vizi e del prodotto riparato e nuovo, smaltimento per legge, diarie e trasferte, mezzi di sollevamento, impalcature, ecc.), che restano a carico dell'acquirente; vizi/difetti causati da negligenza nell'installazione dei prodotti oppure da negligenza nella movimentazione logistica dei prodotti; vizi causati da eventi imprevedibili e imprevedibili, casi fortuiti e cause di forza maggiore (comprese influenze chimiche, scariche elettriche, fulmini, sovraccarichi di tensione in genere non tollerati dal prodotto), e tutte le cause che escludano la riconducibilità di tali vizi al processo di fabbricazione del prodotto stesso; prodotti realizzati su espressioni specifiche dell'acquirente; le parti soggette a usura, quali per esempio materiali di consumo come sorgenti luminose (sorgenti LED escluse), accumulatori, parti meccaniche soggette ad usura; i prodotti riportanti marchio di aziende diverse, che ATENA LUX commercializza e i sistemi di gestione della luce.
1. *Buyers are responsible for the choice of items in relation to their characteristics and the use for which they are intended. It is therefore recommended to carry out assembly and use according to the rules of art and good technique, consulting and keeping the instruction sheets attached to each product.*
 2. *The warranty will be provided for a period of 12 months from the date of issue of the sales invoice and is limited to parts deemed defective at origin or unserviceable due to defects in material or construction defects by ATENA LUX.*
 3. *With the exception of some specific products, it is possible to request an extension of the warranty to 5 years from the date of the invoice, by submitting the request when defining the order and in any case in the manner and within the times established in the specific warranty extension form, downloadable at www.atenalux.com. The validity of the warranty extension will be assessed at the sole discretion of ATENA LUX.*
 4. *The warranty does NOT cover: all possible accessory costs arising as a result of the repair of the defect / defect (eg. Those relating to the repair of third parties, assembly and disassembly, transport of the product affected by defects and the repaired product and new, disposal by law, per diem and transfers, lifting equipment, scaffolding, etc.), which remain the responsibility of the buyer; defects / faults caused by negligence in the installation of the products or by negligence in the logistical handling of the products; defects caused by unforeseen and unforeseeable events, fortuitous events and causes of force majeure (including chemical influences, electric discharges, lightning, voltage overloads generally not tolerated by the product), and all the causes that exclude the traceability of such defects to the manufacture of the product itself; products made on the express specifications of the buyer; parts subject to wear, such as consumables such as light sources (excluding LED sources), accumulators, mechanical parts subject to wear; the products bearing the brands of different companies, which ATENA LUX markets and the lighting management systems.*

CONTESTAZIONI DISPUTES

1. I disegni, i campioni, i documenti, i progetti, gli studi e i calcoli illuminotecnici di proprietà di ATENA LUX non possono essere né divulgati, né pubblicati, né riprodotti senza autorizzazione scritta da parte della stessa. L'acquirente si impegna a non utilizzare direttamente, indirettamente, per interposta persona, ente o società e a non rivelare a terzi, anche dopo la cessazione dei rapporti commerciali, nessuna delle informazioni di cui sia venuto a conoscenza in occasione del rapporto contrattuale con ATENA LUX, che sono da ritenersi assolutamente riservate se non nei limiti dell'uso al quale sono finalizzate.
 2. Per quanto non contemplato nelle presenti condizioni generali di vendita faranno testo le norme di legge vigenti in Italia. Per qualsiasi controversia l'unico foro competente è quello di Pordenone.
1. *The drawings, samples, documents, projects, studies and lighting planning calculations owned by ATENA LUX cannot be divulged, published or reproduced without written authorization from the same. The buyer undertakes not to use directly, indirectly, through a third party, entity or company and not to disclose to third parties, even after the termination of the commercial relations, any of the information that he has become aware of during the contractual relationship with ATENA LUX, which are to be considered absolutely confidential except within the limits of the use to which they are intended.*
 2. *For anything not contemplated in these general conditions of sale, the laws in force in Italy will apply. For any dispute, the only competent court is that of Pordenone.*

Al fine di un continuo miglioramento della gamma, Atena Lux si riserva il diritto di apportare modifiche, in qualsiasi momento e senza preavviso, alle specifiche dei prodotti descritti.
Le immagini e le riproduzioni dei prodotti sono da ritenersi esemplificative.

*In order to obtain better performances, Atena Lux reserves the right to modify products specifications, at any time and with no prior warning.
Images and reproductions of all products shall be considered illustratives.*



 **Atena Lux srl**
via Giai 33
30020 Gruaro
Venice, Italy

 +39 0421 760100

 +39 0421 760225

 info@atenalux.com

 atenalux

 www.atenalux.com

