



atena *lux*<sup>®</sup>

# HEALTH CARE

Lighting &  
Bedhead Units

TRAVI TESTALETTO OSPEDALIERE  
*BEDHEAD UNITS FOR HOSPITALS*

TRAVI TESTALETTO PER RESIDENZE SANITARIE ASSISTITE  
*BEDHEAD UNITS FOR NURSING HOMES*

SALE OPERATORIE E CAMERE BIANCHE  
*OPERATING THEATRES AND CLEAN ROOMS*



Lighting and  
Medical Devices

3 AZIENDA / COMPANY

6 HUMAN CENTRIC LIGHTING

8 CASO STUDIO / CASE STUDY

12 TRAVI TESTALETTO OSPEDALIERE  
BEDHEAD UNITS FOR HOSPITALS



14 NORMATIVE  
REGULATIONS

15 PRETUBAGGIO  
PRE-PIPING

● 18 AUXILIA 

● 24 SENSE 

● 28 SANIMED / SANITECH SYSTEM 

● 34 ARMONIA 

● 40 THERAPY 

● 54 TRIAL 

60 TRAVI TESTALETTO  
PER RESIDENZE SANITARIE ASSISTITE  
BEDHEAD UNITS FOR NURSING HOMES



● 62 AIRWALL

● 66 SAFE-WAY

● 70 STAIR CARE

● 72 SKYWALL

● 74 WAY WALL

● 76 LEVEL

● 78 HORIZON

80 PERSONALIZZAZIONE E ACCESSORI  
CUSTOM AND ACCESSORIES



● 82 PERSONALIZZAZIONE  
CUSTOM

● 84 FINITURE  
FINISHINGS

● 85 SISTEMA DI CHIAMATA  
NURSE CALLING SYSTEM

● 86 ACCESSORI  
ACCESSORIES

● 87 SISTEMA PENSILE  
SUSPENSION SYSTEM

88 SALE OPERATORIE E CAMERE BIANCHE  
OPERATING THEATRES AND CLEAN ROOMS

● 90 SISTEMA CERTIFICATO PER SALE OPERATORIE  
CERTIFIED SYSTEM FOR OPERATING  
THEATRES

● 91 ILLUMINAZIONE PER SALE OPERATORIE  
LIGHTING FOR OPERATING THEATRES

● 96 ILLUMINAZIONE SPECIFICA PER AMBIENTI A  
CONTAMINAZIONE CONTROLLATA  
SPECIFIC LIGHTING FOR CONTROLLED  
CONTAMINATION ENVIRONMENTS

98 PITTOGRAMMI  
PICTOGRAMS



## ATENA LUX

Fondata nel 1994, ATENA LUX è una realtà dinamica e giovane riconosciuta sul territorio nazionale ed estero come produttore di corpi illuminanti e di travi testaletto. Il comparto produttivo, situato a Gruaro (VE), ricopre una superficie di 4933 mq e vanta un parco macchine utensili di ultima generazione. Dalla progettazione alla produzione, uno staff altamente qualificato realizza soluzioni personalizzate di qualità che sono sinonimo di garanzia, comfort e sicurezza. Grazie agli sforzi profusi nell'ambito della ricerca, negli ultimi anni l'azienda è cresciuta notevolmente nel settore medicale, ampliando la propria proposta con nuovi modelli di travi testaletto e lampade specifiche per sale operatorie.

*Founded in 1994, ATENA LUX is a dynamic and young company, recognised as manufacturer of lighting solutions and bedhead units on domestic and foreign markets. The production area, located in Gruaro (VE), covers a surface of 4933 square meters and boasts several latest technology machines. From design to production, a highly qualified staff creates customized quality solutions that are synonymous with guarantee, comfort and safety. Thanks to profuse research efforts, in these last years the company has grown considerably in the medical sector, increasing its offer with new models of bedhead units and specific lamps for operating theatres.*

[www.atenalux.com](http://www.atenalux.com)



## ATTENZIONE PER IL CLIENTE

Il continuo dialogo con il cliente ha permesso all'azienda di trasformarsi e plasmare le proprie creazioni secondo le necessità specifiche del committente. Ciò che contraddistingue e crea valore aggiunto ai prodotti ATENA LUX è la capacità dell'azienda di ascoltare le esigenze specifiche e di produrre prodotti personalizzati. Consulenza, sviluppo progettuale e calcolo illuminotecnico sono servizi che l'azienda mette a disposizione e che generano un rapporto di fiducia e continuità con i clienti.

## PROCESSO PRODUTTIVO MADE IN ITALY

Nel corso degli anni il comparto produttivo si è trasformato al passo con l'evoluzione delle materie prime e delle tecnologie per la loro lavorazione. L'efficientamento dei processi produttivi e l'adozione di metodologie di produzione ispirate alle logiche di Lean Manufacturing hanno permesso all'azienda di mantenere uno standard qualitativo ed economico competitivo sul mercato. I prodotti prendono forma attraverso il taglio laser, la punzonatura e la lavorazione degli estrusi di alluminio, mantenendo manuale l'assemblaggio e il cablaggio è stato inoltre possibile mantenere la flessibilità che spesso viene richiesta per esigenze di cantiere. Grazie alla presenza di un laboratorio fotometrico interno, i corpi illuminanti vengono sottoposti a test illuminotecnici da cui si ricavano i dati necessari per elaborazioni progettuali.

## CUSTOMER CARE

*A constant communication with the customer has allowed the company to transform and shape its creations according to the specific customer's needs. The added value, that distinguishes the ATENA LUX products, is the company's ability to listen to specific exigencies and producing customized products. Thanks to several services that the company provides, like consulting, project development and lighting planning calculation, ATENA LUX has established a continuous relationship based on trust with customers.*

## PRODUCTION PROCESS MADE IN ITALY

*Over the years the production sector has evolved at the same speed with the evolution of the raw materials and the processing technologies. Taking inspiration from the Lean Manufacturing logic, the efficiency of production processes and the adoption of new production methods have allowed the company to maintain a competitive quality and economic standard on the market. Products take shape through laser cutting, punching and processing of aluminum extrusions. At the same time, keeping the assembly and wiring process manual, it was also possible to maintain the flexibility that is often required for site exigencies. Thanks to the presence of an internal photometric laboratory, the lighting fittings are subjected to lighting tests that enable to obtain the necessary data for lighting project elaborations.*

## I PRINCIPI DI QUALITÀ DELL'AZIENDA

Il sistema produttivo segue un iter qualitativo per la certificazione dei dispositivi elettromedicali. I prodotti, la cui garanzia è estendibile fino a 5 anni, sono soggetti a collaudo finale prima dell'immissione sul mercato attraverso specifici test di prova in linea con i requisiti della normativa vigente. La scrupolosa analisi sulla scelta delle materie prime e la concreta e leale collaborazione con i propri fornitori rimangono il punto di partenza per lo sviluppo di prodotti affidabili e sicuri.

## RESPONSABILITÀ SOCIALE

L'adozione di una strategia di sviluppo basata sui temi della sostenibilità è alla base di un percorso di lungo termine che ATENA LUX ha deciso di intraprendere volontariamente. L'azienda si sta avvicinando ai temi della sostenibilità partendo dai valori positivi del management. Consapevole che i processi di innovazione che prendono vita in azienda si riflettono sulla società attraverso strategie economiche, progetti sociali e culturali, ATENA LUX è proiettata verso una trasformazione e crescita che coinvolga non soltanto l'azienda ma anche la società.

## BIM

Attraverso lo sviluppo della libreria BIM (Building Information Modeling) delle travi testaletto, l'azienda permette al progettista di creare modelli dettagliati delle architetture e di condividere con tutto il team di progettazione ogni dettaglio e caratteristiche dei prodotti inseriti nel progetto. In un ambiente critico come un ospedale dove la sicurezza è di primaria importanza, l'illuminazione svolge un ruolo chiave nella creazione di ambienti sicuri e confortevoli. Grazie al BIM, in fase di progettazione è possibile simulare scenari di illuminazione, valutando come la luce influenzi la visibilità e la percezione dei colori in diverse aree ospedaliere.

## THE COMPANY'S QUALITY PRINCIPLES

*The production system follows a qualitative process for the certification of the electromedical devices. The products, whose warranty can be extended up to 5 years, are subject to final testing before being put on the market, through specific tests in line with the requirements of the reference normative. The scrupulous analysis on the choice of raw materials and the concrete and fair collaboration with the suppliers remain the starting point for the development of reliable and safe products.*

## SOCIAL RESPONSABILITY

*The adoption of a development strategy based on sustainability issues is the basis of a long-term process that ATENA LUX has decided to start voluntarily. The company is approaching the issues of sustainability starting from the positive values of the management. Aware that the innovation processes that come to life in the company are reflected on society through economic strategies, social and cultural projects, ATENA LUX is projected towards a transformation and growth that involves not only the company but also the society.*

## BIM

*By developing the BIM (Building Information Modeling) library of bedhead units, the company provides designers with the opportunity to create detailed models of the architecture as well as share every detail and characteristic of the products that are included in the project with the entire design team. Lighting plays a significant role in creating a safe and comfortable atmosphere in hospital environments, where safety is of primary concern. By using BIM, it is possible to simulate lighting scenarios during the design phase, evaluating how light impacts visibility and color perception in different areas of a hospital.*

# HUMAN CENTRIC LIGHTING



## Quando la luce può rendere più confortevole l'ambiente ospedaliero

Il principio della HCL (Human Centric Light) è molto apprezzato negli ospedali e nelle case di cura nell'ultimo periodo. In questi luoghi l'accesso alla luce naturale è molto limitata, perciò è necessaria una luce artificiale che rispetti il ritmo naturale del giorno. I sistemi HCL portano dei benefici consistenti nel trattamento dei degenti con diverse patologie, aiutandoli nella riabilitazione e migliorando la qualità della vita.

Le testate e i corpi illuminanti ATENA LUX integrano LED con differenti temperature di colore e alimentatori dimmerabili. La gestione dell'illuminazione avviene attraverso sistemi di regolazione automatica sincronizzati all'orologio astronomico con fuso orario locale.

Le sorgenti luminose utilizzate all'interno dei corpi illuminanti ATENA LUX sono moduli LED che integrano chip di diverse temperature di colore (2700K-6500K). L'azienda ha realizzato secondo le proprie specifiche esigenze una linea di moduli lineari in grado di adattarsi perfettamente ai corpi illuminanti esistenti.

Il sistema di illuminazione HCL è gestito da una centralina programmabile in relazione alla posizione geografica o secondo particolari esigenze, e include un orologio astronomico che permette un'autoregolazione dell'intensità e della temperatura di colore della luce, secondo la naturale successione delle ore durante la giornata. Integrando inoltre un sensore di luce e di movimento, si può ottenere un notevole risparmio energetico. La gestione dell'illuminazione avviene in modo semplice attraverso pulsante o Touch panel a parete.

**"la luce è uno strumento potente non farmacologico che può aiutare le persone in diversi modi a stare meglio"**  
LRC Lighting Research Center

## When light can make hospital environment more comfortable

The principle of HCL (Human Centric Light) is very popular in hospitals and nursing homes in recent times. In these places, access to natural light is very limited, so artificial light that respects the natural rhythm of the day is needed. HCL systems bring consistent benefits in treating inpatients with various diseases, helping them in rehabilitation and improving their quality of life.

ATENA LUX bedhead units and luminaires integrate LEDs with different color temperatures and dimmable power supplies. Lighting is managed through automatic dimming systems synchronized to the astronomical clock with local time zone. The light sources used inside ATENA LUX luminaires are LED modules that integrate chips of different color temperatures (2700K-6500K).

The company has created according to its specific requirements a line of linear modules that can be perfectly adapted to existing luminaires. The HCL lighting system is managed by a control unit that can be programmed in relation to geographical location or according to particular requirements, and includes an astronomical clock that allows self-adjustment of the intensity and color temperature of light, according to the natural succession of hours during the day. By also integrating a light and motion sensor, significant energy savings can be achieved. Lighting management is easily done through push button or wall-mounted Touch panel.

**"light is a powerful non-pharmacological instrument that can help people in different ways to feel better"**  
LRC Lighting Research Center

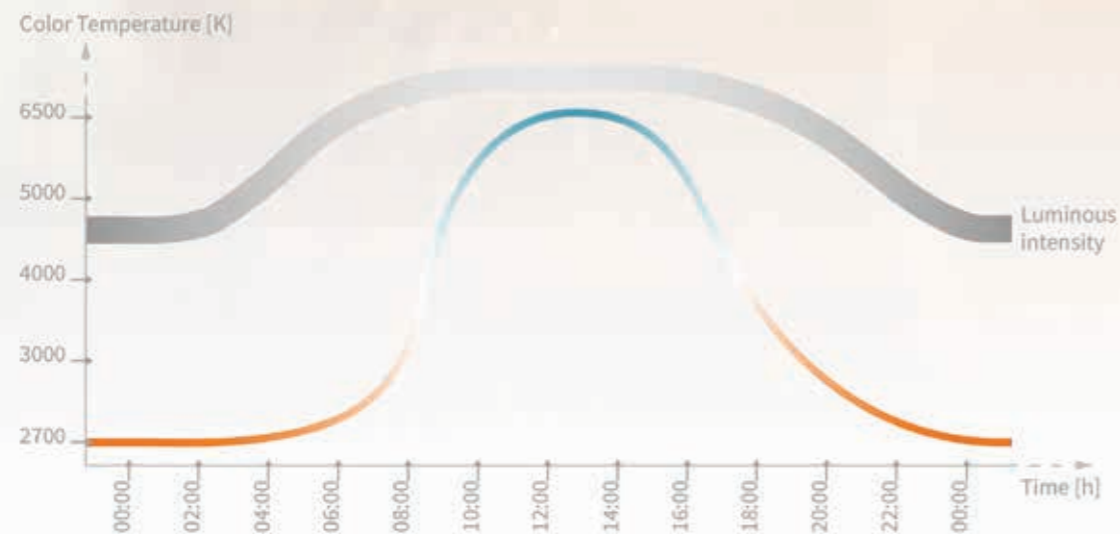

## SISTEMA HCL PER SALE DI DEGENZA

Passando la maggior parte della giornata in luoghi interni, a causa di malattie o problemi di mobilità, i pazienti vanno incontro a un'alterazione del ritmo sonno-veglia, in particolare i pazienti che soffrono di demenza e altre malattie cognitive sono vulnerabili alla mancanza di luce naturale.

Nelle sale di degenza si cerca di riprodurre fedelmente il ciclo della luce naturale, replicando lo stesso colore e intensità della luce durante l'alba, il pomeriggio e il tramonto. Gli effetti nei pazienti e nello staff medico sono positivi e differenti. Per i pazienti, la luce artificiale può compensare la mancanza di luce naturale e ristabilire un buon ritmo sonno-veglia, riducendo la permanenza nella struttura e l'uso di antidepressivi. Anche per lo staff medico i benefici sono rilevanti: i sistemi HCL contrastano l'insorgere dell'insonnia, aumentano il benessere fisico e migliorano il rapporto con i pazienti, riducendo mal di testa e occhi stanchi nei momenti liberi.

## HCL SYSTEMS FOR PATIENT'S ROOMS

Spending most of the day indoors, due to illness or mobility problems, patients experience an alteration in their sleep-wake rhythm, especially patients suffering from dementia and other cognitive diseases are vulnerable to the lack of natural light. In inpatient rooms, an attempt is made to faithfully reproduce the natural light cycle, replicating the same color and intensity of light during sunrise, afternoon and sunset. The effects in patients and medical staff are both positive and different. For patients, artificial light can compensate for the lack of natural light and re-establish a good sleep-wake rhythm, reducing stay in the facility and the use of antidepressants. For the medical staff, the benefits are also significant: HCL systems counteract the onset of insomnia, increase physical well-being, and improve rapport with patients, reducing headaches and tired eyes in free moments.

## SISTEMA HCL PER TERAPIA INTENSIVA

All'interno degli ambienti dedicati alla terapia intensiva l'illuminazione svolge un ruolo fondamentale.

Essa deve soddisfare le complesse esigenze cliniche del reparto e allo stesso tempo rispettare lo stato d'animo dei pazienti e delle rispettive famiglie, mitigando l'ansia e il disorientamento.

L'illuminazione deve essere progettata in modo da consentire al personale medico e paramedico l'adeguato svolgimento delle attività, l'osservazione dei pazienti e della strumentazione.

Allo stesso tempo, l'illuminazione deve avere un effetto gradevole e tranquillante.

## HCL SYSTEM FOR INTENSIVE CARE UNITS

Within intensive care environments, lighting plays a key role. It must meet the complex clinical needs of the ward and at the same time respect the mood of patients and their families, mitigating anxiety and disorientation.

Lighting must be designed so that medical and paramedical staff can adequately perform their activities, observe patients and instrumentation.

At the same time, the lighting should have a pleasant and tranquilizing effect.

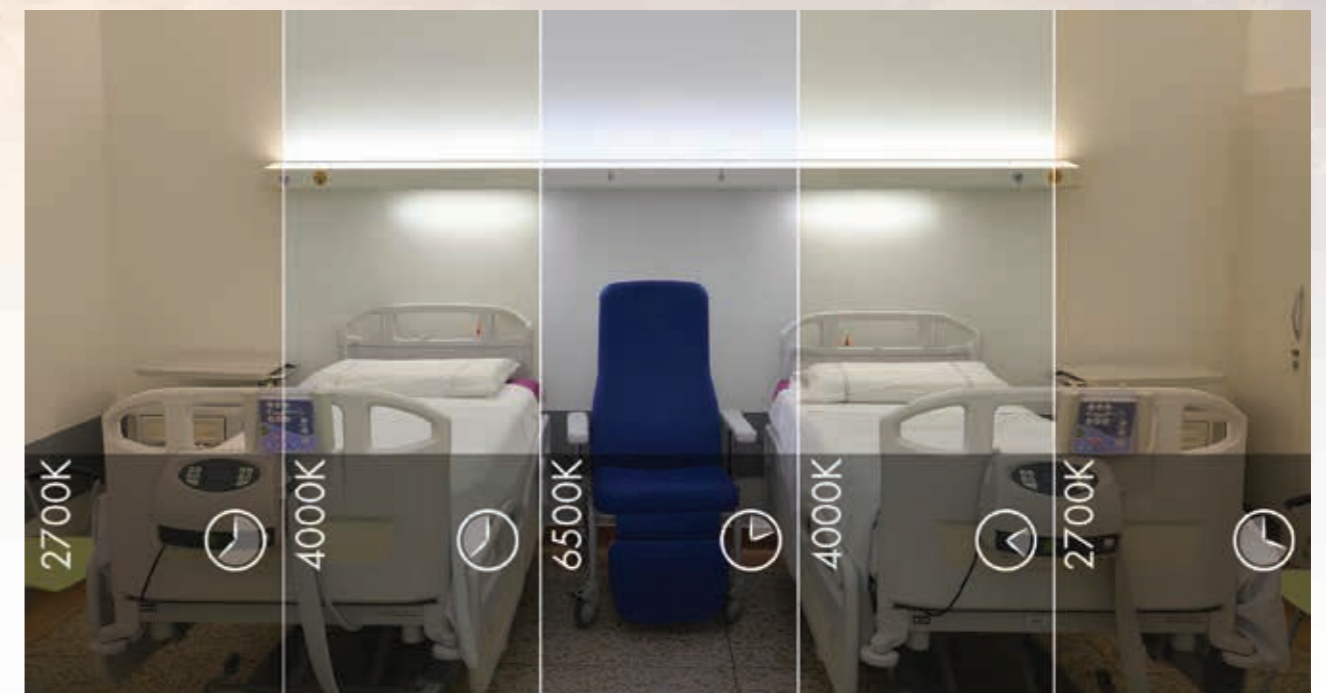

## CASO STUDIO:

# ILLUMINAZIONE AMBIENTALE DELLA CAMERA DI DEGENZA

Nell'illuminazione di un locale di degenza bisogna considerare che il paziente ricoverato si trova, di norma, in condizioni psicofisiche tali da richiedere un'illuminazione ambientale che non infastidisca, prevalentemente di tipo diffusa, di bassa intensità e che non generi abbagliamenti diretti.

Per fare in modo che il paziente venga visitato e medicato nelle migliori condizioni ambientali a disposizione, è necessario avere un'illuminazione diretta, localizzata su tutta la superficie del letto così da garantire livelli di illuminamento adeguati per i compiti visivi che devono essere svolti dal personale ospedaliero.

Non va trascurata, inoltre, l'esigenza di relax della persona costretta a passare lunghi periodi di tempo sdraiata a letto. Proprio per questo è necessario avere a propria disposizione una luce che consenta la lettura, senza infastidire gli altri ricoverati presenti nella stanza.

L'illuminazione fornita all'interno delle camere di degenza deve rispondere a diverse esigenze. I livelli di illuminazione possono variare da valori estremamente bassi (5 lux per l'illuminazione notturna), a valori sufficienti per una corretta percezione dell'ambiente (100 lux), fino a valori molto elevati (500 lux) normalmente necessari per una visita accurata del paziente effettuata dal personale medico.

Le norme **EN 12464-1** e **DIN 5035** raccomandano i **livelli di illuminamento minimi** per lo svolgimento di tutte le attività da parte del personale medico e del paziente all'interno della camera di degenza.

Tutte le travi testaletto ATENA LUX consentono un **risparmio in termini economici** dato sia dall'utilizzo di sorgenti LED, sia dalla riduzione dei costi di installazione e manutenzione dell'impianto elettrico.

Come si nota nella simulazione di progetto di seguito riportata, secondo la normativa di riferimento per una corretta illuminazione non sono necessari, all'interno della camera di degenza, ulteriori punti luce per l'illuminazione d'ambiente che talvolta possono generare un'illuminazione di tipo diretta e sgradevole.

L'ufficio tecnico ATENA LUX è a disposizione per lo sviluppo di **progetti illuminotecnici** personalizzati.

## CASE STUDY:

# AMBIENT LIGHTING IN A PATIENT ROOM

*In the lighting of an inpatient room, it must be considered that the hospitalized patient is, as a rule, in such a psychophysical condition that he or she requires ambient lighting that is not disturbing, predominantly diffuse, low intensity, and does not generate direct glare.*

*To ensure that the patient is examined and medicated in the best environmental conditions available, it is necessary to have direct, localized lighting over the entire surface of the bed so as to ensure adequate illuminance levels for the visual tasks to be performed by the hospital staff.*

*In addition, the need for relaxation of the person forced to spend long periods of time lying in bed should not be overlooked.*

*Precisely for this reason, it is necessary to have at one's disposal a light that allows reading, without bothering other inpatients present in the room.*

*The lighting provided within inpatient rooms must meet a variety of needs. Lighting levels can vary from extremely low values (5 lux for night lighting), to values sufficient for proper perception of the environment (100 lux), to very high values (500 lux) normally required for an accurate examination of the patient by medical staff.*

**EN 12464-1 and DIN 5035 standards recommend minimum illuminance levels for the performance of all activities by medical staff and the patient within the patient room.**

**All ATENA LUX headlamp beams allow for savings in economic terms given both by the use of LED sources and the reduction in electrical installation and maintenance costs. As can be seen in the design simulation below, according to the reference standard for proper lighting, no additional lighting points are needed inside the patient room for ambient lighting, which can sometimes generate direct and unpleasant lighting.**

**The ATENA LUX technical department is available to develop customized lighting designs.**

## AMBIENTE "TIPO" / SAMPLE ROOM

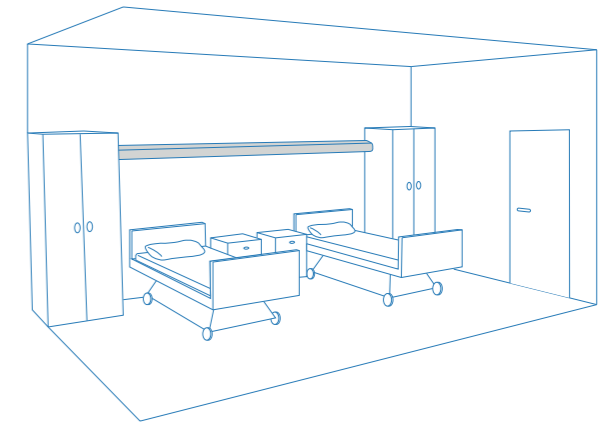
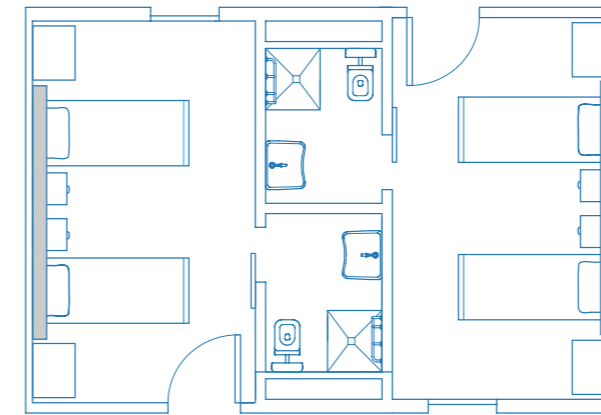

### CARATTERISTICHE CHARACTERISTICS

Dimensioni <i>Dimensions</i>	<b>3,25 x 5,60 m</b>
Altezza locale <i>Room height</i>	<b>2,90 m</b>
Superficie <i>Surface</i>	<b>18,20 m<sup>2</sup></b>

### INDICE DI RIFLESSIONE REFLECTION INDEX

Pavimento <i>Floor</i>	<b>40%</b>
Pareti <i>Wall</i>	<b>60% + 6% (finestra/window)</b>
Soffitto <i>Ceiling</i>	<b>80%</b>
Arredi (chiari) <i>Furniture (light colours)</i>	<b>70%</b>

## TRAVE TESTALETTO SENSE / SENSE BEDHEAD UNIT



### CARATTERISTICHE TECNICHE TECHNICAL SPECIFICATIONS

Dimensioni / <i>Dimensions</i>	<b>3600 x 195 mm h= 121 mm</b>
Altezza installazione <i>Installation height</i>	<b>1,60 – 1,70m (da valutare / to be defined)</b>
Luce indiretta <i>Indirect light</i>	<b>72W 9200lm 128lm/W 4000K CRI&gt;90</b>
Luce lettura <i>Reading light</i>	<b>13W 1173lm 90lm/W 4000K CRI&gt;90</b>
Luce visita <i>Examination light</i>	<b>26W 2340lm 90lm/W 4000K CRI&gt;90</b>
Luce notturna <i>Night light</i>	<b>2W 191lm 90lm/W 4000K CRI&gt;90</b>

## ILLUMINAZIONE GENERALE

Secondo le normative EN 12464-1 e DIN 5035 la quantità di luce sufficiente per permettere lo svolgimento delle attività di routine, sia da parte del personale medico ed ausiliario sia da parte del degente, è di 100 lux calcolata al livello del pavimento.

### GENERAL LIGHTING

According to EN 12464-1 and DIN 5035 regulations, the necessary quantity of light to carry out normal activities (for patients and medical staff) is 100 lux calculated on the floor level.

**Parametri normativa**  
*Regulation parameters*

**E<sub>med</sub> 100 lx**  
UGR < 19  
U<sub>o</sub> > 0,40  
Ra > 80

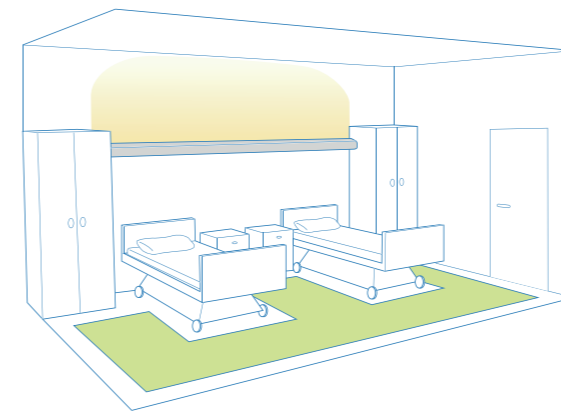
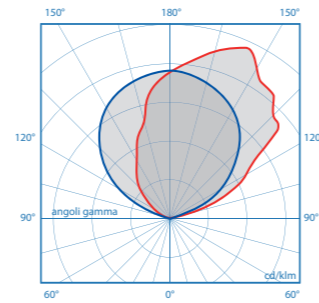

E<sub>med</sub> 129 lx

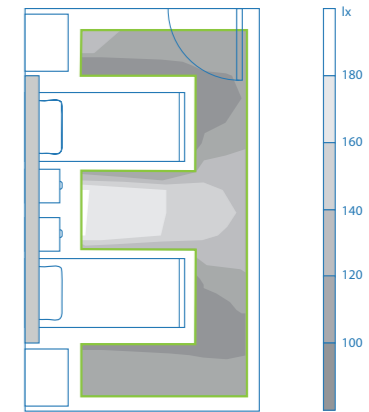

## LUCE LETTURA

Le normative EN 12464-1 e DIN 5035 raccomandano un livello di illuminamento di 300 lux. Generalmente si assume come riferimento il piano di lettura dato da un'area di larghezza 90cm e lunghezza 30cm, posto ad un metro dalla testata del letto, ad un'altezza di 1,1m dal pavimento e avente un'inclinazione di 75°.

### READING LIGHT

EN 12464-1 and DIN 5035 rules recommend a lighting level of 300 lux on a reading plane (dimensions: 90cm x 30cm, located at a distance of 1m from the head of the bed, 1,1m high and with an inclination of 75°).

**Parametri normativa**  
*Regulation parameters*

**E<sub>med</sub> 300 lx**  
UGR < 19  
U<sub>o</sub> > 0,70  
Ra > 80

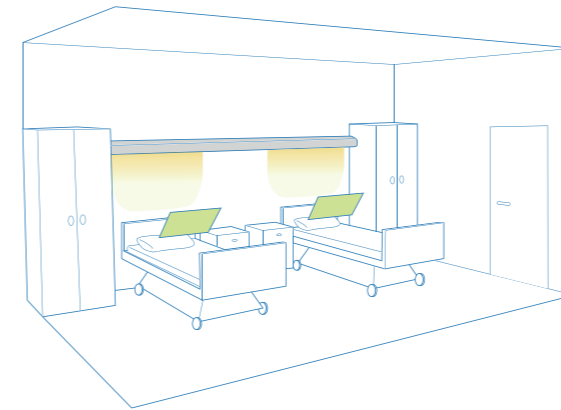
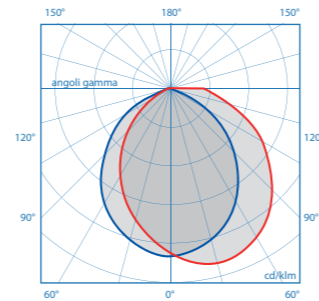

E<sub>med</sub> 327 lx

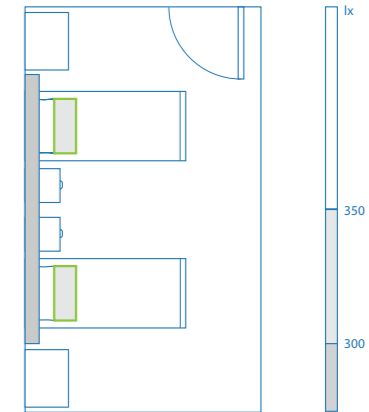

## LUCE VISITA SEMPLICE

Le normative EN 12464-1 e DIN 5035 raccomandano un livello minimo di illuminamento di 300 lux sull'area dell'intero letto, ad un'altezza di 0,85m da terra.

### SIMPLE EXAMINATION LIGHTING

EN 12464-1 and DIN 5035 regulations recommend a minimum lighting level of 300 lux on the entire size of the bed, at 0,85m from the floor.

**Parametri normativa**  
*Regulation parameters*

**E<sub>med</sub> 300 lx**  
UGR < 19  
U<sub>o</sub> > 0,60  
Ra > 80

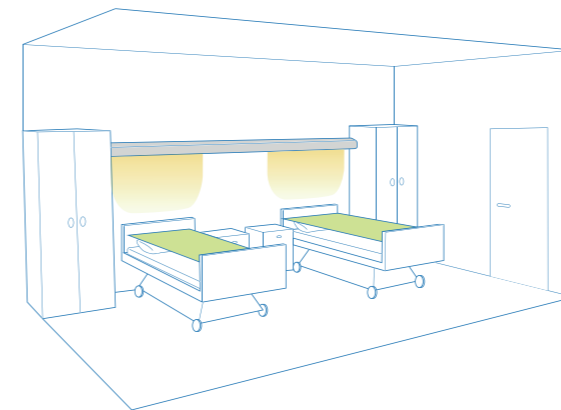
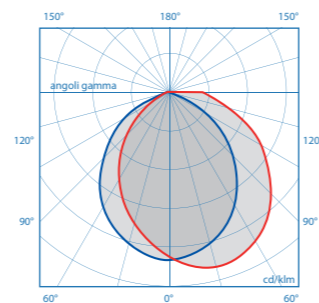

E<sub>med</sub> 311 lx

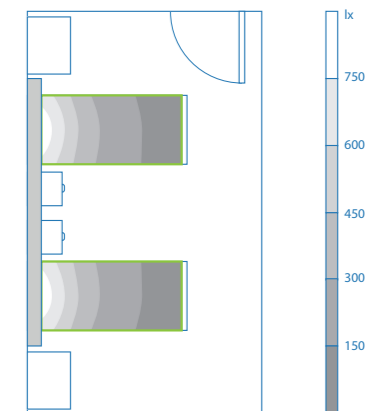

## LUCE NOTTURNA

Quantità di luce necessaria per garantire l'orientamento del personale e dei degenti durante le ore notturne. Viene generata da un'emissione di tipo indiretta mediante una sorgente luminosa a LED che deve garantire minimo 5 lux ad un'altezza di 0,85m.

### NIGHT LIGHT

Necessary quantity of light to guarantee the orientation of patients and medical staff during the night. It is given by an indirect emission through LED lighting source that must guarantee 5lux minimum at a 0,85m height.

**Parametri normativa**  
*Regulation parameters*

**E<sub>med</sub> 5 lx**  
UGR /  
U<sub>o</sub> /  
Ra > 80

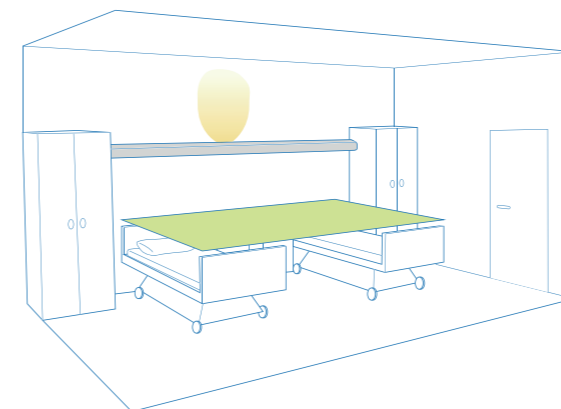
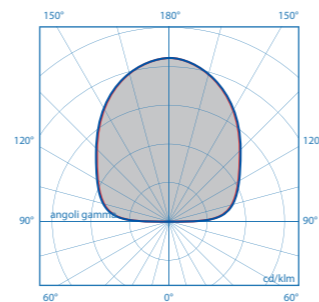

E<sub>med</sub> 5 lx

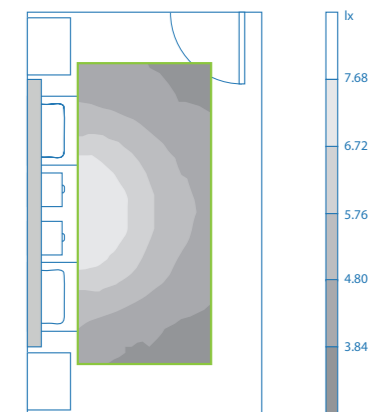



# TRAVI TESTALETTO OSPEDALIERE

## *BEDHEAD UNITS FOR HOSPITALS*



Degenza  
Patient room



Terapia Intensiva  
Intensive care



Laboratorio  
Laboratory

### ● AUXILIA



18

### ● SENSE



24

### ● SANIMED SANITECH SYSTEM



28

### ● ARMONIA



36

### ● THERAPY



40

### ● TRIAL



54

# NORMATIVE

## CERTIFICAZIONI E GARANZIE

I prodotti elettromedicali ATENA LUX sono conformi a tutte le normative obbligatorie in ambito ospedaliero e possiedono la **marcatatura CE**, indispensabile ed obbligatoriamente applicata su tutti i dispositivi elettromedicali.

Secondo quanto definito dal **regolamento europeo UE 2017/745**, le travi testaletto ATENA LUX sono dei **dispositivi medici** e sono destinate all'installazione in camere di degenza, sale di preparazione alle operazioni e postoperatorie, sale di fisioterapia, sale parto, ambulatori, laboratori.

Con le norme tecniche **UNI EN ISO 11197 e CEI EN 60601-1** viene stabilita la loro idoneità ad essere apparecchi elettromedicali per quanto riguarda le caratteristiche generali, sicurezza ed integrità del prodotto nel tempo.

Secondo il **regolamento europeo UE 2017/745** le unità testaletto di ATENA LUX sono dispositivi classificabili nelle classi I, IIa, IIb. Le testaletto prive di predisposizione per i gas medicali rientrano nella classe I.

Le versioni realizzate in modo tale da permettere la predisposizione o l'implementazione dell'impianto per i gas medicinali rientrano nella classe IIa / IIb. I modelli di classe IIa / IIb sono certificati dall'ente nazionale **ITALCERT** con riferimento al **certificato n° 015-00-00-MDR**.

- **UE 2017/745**  
Regolamento sui dispositivi medici
- **CEI EN 60601-1**  
Apparecchi elettromedicali
- **UNI EN ISO 11197**  
Unità di alimentazione per uso medico
- **EN 60598**  
Apparecchi di illuminazione
- **EN 62471**  
Sicurezza fotobiologica
- **EN 55015, EN 61000**  
Compatibilità elettromagnetica
- **UNI CEI EN ISO 14971**  
Dispositivi medici  
Applicazione della gestione dei rischi ai dispositivi medici
- **UNI CEI EN ISO 13485**  
Dispositivi medici  
Sistemi di gestione per la qualità  
Requisiti per scopi regolamentari



## REGULATIONS CERTIFICATION AND SECURITY

ATENA LUX electromedical devices are compliant with all the European regulations regardin addition, they have the **CE branding** which is necessary and mandatory for all the electro-medical devices.

As defined by the **UE 2017/745** European regulation, ATENA LUX bedhead units are **medical devices** and are intended for installation in hospital rooms, operation and post-operative preparation rooms, physiotherapy rooms, delivery rooms, outpatient clinics, laboratories.

The **UNI EN ISO 11197** and **CEI EN 60601-1** technical norms establish the suitability of bedhead units to be medical devices once examined their general characteristics, security and integrity.

According to the **EU 2017/745** European regulation, ATENA LUX bed head units are devices classifiable in classes I, IIa, IIb. The bed head units without provision for medical gases fall into class I.

The versions made in such a way as to allow the preparation or implementation of the plant for medicinal gases fall into class IIa / IIb. The class IIa / IIb models are certified by the national body **ITALCERT** with reference to certificate n° **015-00-00-MDR**.

- **UE 2017/745**  
Medical Devices Regulation
- **CEI EN 60601-1**  
Electro-medical devices
- **UNI EN ISO 11197**  
Medical supply units
- **EN 60598**  
Lighting devices
- **EN 62471**  
Photobiological safety
- **EN 55015, EN 61000**  
Electromagnetic compatibility
- **UNI CEI EN ISO 14971**  
Medical devices  
Application of risk management to medical devices
- **UNI CEI EN ISO 13485**  
Medical devices  
Quality management systems  
Requirements for regulatory purposes

## PRETUBAGGIO

Per far fronte all'esigenza di implementazione dei gas medicali, i dispositivi ATENA LUX di classe IIa e IIb sono realizzati in modo tale da integrare al loro interno il **circuito e le prese dei gas tecnici**, consentendo l'installazione da 1 a 4 tubazioni in rame per la distribuzione di ossigeno, protossido, vuoto e aria compressa. Tuttavia, in casi specifici, è possibile richiedere il **pretubaggio**, cioè l'inserimento e la saldatura delle tubature di rame alle prese dei gas all'interno delle travi testaletto. Questa attività avviene direttamente all'interno dello stabilimento durante il processo produttivo delle testaletto. La procedura del pretubaggio viene svolta da **operatori qualificati** che attestano l'idoneità dei dispositivi medici ATENA LUX all'installazione e collaudo degli impianti dei gas medicali.

Normative di riferimento:  
UNI EN ISO 13485  
UNI EN 7396-1  
EN ISO 13585



## PRE-PIPING

In order to enable the implementation of medical gases, ATENA LUX bedhead units of class IIa and IIb are equipped with houses **circuit and connections for technical gases** and allow the installation until four copper pipes for oxygen, protoxide, vacuum and compressed air distribution. In some specific situation, on request, it is possible to provide the **pre-piping**, that is the insertion and welding of the copper pipes to the gas outlets inside the bedhead units. This activity takes place directly inside the production plant during the bedhead units production process. The pre-piping activity is performed by **certified operators** who certify the suitability of ATENA LUX medical devices for the installation and testing of medical gas systems.

Reference regulations:  
UNI EN ISO 13485  
UNI EN 7396-1  
EN ISO 13585

## TESTALETTO PER LOCALI AD USO MEDICO DI GRUPPO 0, 1 E 2

Gli impianti elettrici nei locali adibiti ad uso medico devono sottostare alle indicazioni dettate dalla norma CEI 64-8. Tale norma definisce quali sono i locali ad uso medico e la loro classificazione in 3 gruppi.

La classificazione dei locali ad uso medico avviene dopo un'attenta individuazione da parte dell'ingegneria clinica dei rischi per il paziente, e considera una specifica conoscenza degli impianti elettrici e degli apparecchi elettromedicali all'interno degli ambienti.

Le travi testaletto ATENA LUX vengono considerate unità di alimentazione per uso medico che integrano in un unico blocco servizi elettrici di illuminazione, di distribuzione energia, servizi di comunicazione, trasmissione dati, erogazione ossigeno terapeutico, gas medicali, vuoto, aria complessa sterile, ecc.

Come tali sono destinate ai seguenti gruppi di appartenenza:

GRUPPO 0

Locale ad uso medico nel quale non si utilizzano apparecchi elettromedicali con parti applicate, che perciò non entrano in contatto fisico con il paziente.

Fanno parte di questo gruppo i corpi illuminanti specifici per stanze di degenza e in particolare per le case di riposo: AIRWALL, STAIR, SKYWALL, HORIZON, WAY WALL, LEVEL.

GRUPPO 1

Locale ad uso medico nel quale le parti applicate sono destinate ad essere utilizzate esternamente oppure invasivamente in qualsiasi parte del corpo ad eccezione delle zone cardiache.

Le testaletto ATENA LUX configurabili secondo i locali di gruppo 1, destinate alla degenza, sono: AIRWALL MED, AIRWALL CALL MED, AUXILIA, SENSE, SANIMED, ARMONIA, THERAPY, TRIAL.

GRUPPO 2

Locale ad uso medico nel quale le parti applicate sono destinate ad essere utilizzate per operazioni chirurgiche o il paziente è sottoposto a trattamento vitale, dove la mancanza dell'alimentazione può comportare pericolo di vita.

Secondo gli standard progettuali di ATENA LUX, le travi testaletto destinate ai locali di gruppo 2 vengono realizzate complete di:  
protezione di ogni singola presa elettrica;  
circuito FM suddiviso in 2 circuiti;  
LED di segnalazione presenza rete su ogni presa elettrica.

Di questo gruppo fanno parte tutti i modelli di testaletto ospedalieri (AUXILIA, SENSE, SANIMED, ARMONIA, THERAPY, TRIAL), la cui configurazione riporta il **soffisso .2**.

## BEDHEAD UNITS FOR MEDICAL PREMISES OF GROUP 0, 1 AND 2

The electrical systems inside medical premises must comply with the instructions dictated by the CEI 64-8 standard. This standard defines the premises for medical use and their classification in 3 groups.

The classification of the medical premises occurs after a careful identification by the clinical engineering of the risks for the patient, and considers a specific knowledge of the electrical systems and electromedical devices inside the hospital.

The ATENA LUX bedhead units are considered medical supply units which integrate into a single device several services: electrical lighting, energy distribution, communication services, data transmission, therapeutic oxygen supply, medical gases, vacuum, sterile complex air, etc..

They are divided into these following groups:

GROUP 0

Medical premises where electromedical devices are not used directly on applied parts, therefore they do not come into physical contact with the patient.

Specific wall lighting fittings for nursing homes are part of this group: AIRWALL, STAIR, SKYWALL, HORIZON, WAY WALL, LEVEL.

GROUP 1

Medical premises where the applied parts are intended to be used externally or invasively in any part of the body except for the cardiac zone.

ATENA LUX bedheads that can be configured according to group 1 premises are: AIRWALL MED, AIRWALL CALL MED, AUXILIA, SENSE, SANIMED, ARMONIA, THERAPY, TRIAL.

GROUP 2

Medical premises where the applied parts are intended to be used for surgical operations or where the patient is subjected to vital treatment and a lack of feeding can be life threatening.

According to ATENA LUX product development process, the bedhead units intended for medical premises of group 2 are made complete with:  
protection of every single electric socket;  
FM circuit divided into 2 circuits;  
Network presence LED for each electrical socket.

This group includes all the hospital bedhead units (AUXILIA, SENSE, SANIMED, ARMONIA, THERAPY, TRIAL), whose configuration contains the **suffix .2**.

# AUXILIA

Nata da un accurato studio dei dettagli tecnici ed estetici, AUXILIA coniuga funzionalità, assistenza, igienicità e design rendendo più confortevole e affidabile la sistemazione di un paziente. AUXILIA dispone di **luce diretta, indiretta e notturna** ed è predisposta per l'eventuale alloggiamento di tubazioni e unità terminali per l'erogazione dei **gas medicinali**. Una trave testaleto completa per piccole e grandi realtà ospedaliere.

*Thanks to an accurate study of the technical and aesthetic details, AUXILIA combines functionality, assistance, cleanliness and elegance contributing to make the patient stay more comfortable and reliable. AUXILIA offers **direct, indirect and night light** and it is suitable for the installation of the **medical gases systems**. An appropriate bedhead unit for small and big hospital environments.*

- › **AUXILIA L**
- › **AUXILIA LD**
- › **AUXILIA LDG**
- › **AUXILIA LDGS**

#### **CLASSIFICAZIONE SECONDO REGOLAMENTO (UE) 2017/745** *CLASSIFICATION ACCORDING TO THE REGULATION (EU) 2017/745*

- › Classe I (senza gas) - IIa/IIb (con gas)
- › Funzionamento continuo
- › Senza parti applicate
- › Installabile in locali per uso medico di gruppo 0, 1 e 2
- › Non idoneo per essere installato in ambienti con rischio esplosione (presenza di gas e vapori infiammabili)
- › Non installabile in ambienti ricchi di ossigeno con concentrazione superiore al 25% con una pressione ambientale sino a 110 kPa in condizioni normali
- › Non idoneo alle prescrizioni relative alle categorie AP e APG
- › *I class (no gas) - IIa/IIb (with gas)*
- › *Non-stop operation*
- › *No sections are applied*
- › *Suitable for the installation in group 0, 1 and 2 medical premises*
- › *Not suitable for the installation in explosion risk environments (locations with gases and flammable vapours)*
- › *Not suitable for the installation in environments with an oxygen amount superior to the 25% with an environmental pressure until the 110kPa in usual circumstances*
- › *Not suitable for the categories AP and APG provisions*

#### **DIRETTIVE E NORMATIVE DI RIFERIMENTO** *REFERENCE DIRECTIVES AND REGULATIONS*

(EU) 2017/745  
 UNI EN ISO 11197  
 CEI EN 60601-1  
 CEI EN 60598  
 CEI EN 55015  
 CEI EN 61547  
 UNI CEI EN ISO 14971  
 UNI CEI EN ISO 13485

# AUXILIA



## CARATTERISTICHE GENERALI GENERAL FEATURES

CORPO / BODY	Estroso in alluminio	Extruded aluminium
OTTICA / DIFFUSER	Metacrilato opale per luce lettura/visita Policarbonato opale per luce ambiente	Opal methacrylate diffuser for reading/examination lighting Opal polycarbonate diffuser for general lighting
LUNGHEZZA MASSIMA* / MAXIMUM LENGTH*	3700 mm	3700 mm
GRADO IP / PROTECTION DEGREE	<div style="display: flex; gap: 5px;"> <div style="border: 1px solid black; padding: 2px;">IP20</div> generale             <div style="border: 1px solid black; padding: 2px;">IP40</div> circuito di illuminazione             <div style="border: 1px solid black; padding: 2px;">IP21</div> prese elettriche           </div>	<div style="display: flex; gap: 5px;"> <div style="border: 1px solid black; padding: 2px;">IP20</div> general             <div style="border: 1px solid black; padding: 2px;">IP40</div> lighting circuit             <div style="border: 1px solid black; padding: 2px;">IP21</div> electrical sockets           </div>
COLORE STANDARD** / STANDARD COLOUR**	RAL 9010 Opaco	Opaque RAL 9010
TRATTAMENTO SUPERFICIALE A RICHIESTA SURFACE TREATMENT ON REQUEST	Anodizzazione, verniciatura anti-microbica, finitura decorativa	Anodization, antimicrobial coating, decorative finishing



## CARATTERISTICHE ILLUMINOTECNICHE LIGHTING FEATURES



Potenza Power [W]	Temp. colore Colour Temp. [K]	IRC CRI	Flusso lum.*** Lum. flux*** [lm]		Efficienza lum. Lum. effic. [lm / W]	Dimensioni/Dimensions [mm]						
			↑	↓		A	B	h L	h LD	h LDG		
↑26 ↓13	2	3000	>90	↑2652 ↓1229	233	↑102 ↓95	116	217	1300	150	260	370
↑26 ↓13	2	4000	>90	↑3173 ↓1470	233	↑122 ↓113	116	217	1300	150	260	370
↑48 ↓26	2	3000	>90	↑4896 ↓2457	233	↑102 ↓95	116	217	1300	150	260	370
↑48 ↓26	2	4000	>90	↑5858 ↓2940	233	↑122 ↓113	116	217	1300	150	260	370
↑32 ↓13	2	3000	>90	↑3264 ↓1229	233	↑102 ↓95	116	217	1300	150	260	370
↑32 ↓13	2	4000	>90	↑3906 ↓1470	233	↑122 ↓113	116	217	1300	150	260	370
↑32 ↓26	2	3000	>90	↑3264 ↓2457	233	↑102 ↓95	116	217	1600	150	260	370
↑32 ↓26	2	4000	>90	↑3906 ↓2940	233	↑122 ↓113	116	217	1600	150	260	370
↑60 ↓13	2	3000	>90	↑6120 ↓1229	233	↑102 ↓95	116	217	1600	150	260	370
↑60 ↓13	2	4000	>90	↑7323 ↓1470	233	↑122 ↓113	116	217	1600	150	260	370
↑60 ↓26	2	3000	>90	↑6120 ↓2457	233	↑102 ↓95	116	217	1600	150	260	370
↑60 ↓26	2	4000	>90	↑7323 ↓2940	233	↑122 ↓113	116	217	1600	150	260	370

\*Lunghezza riferita alla lavorazione in un unico pezzo. \*Length referred to a single-block version.  
\*\*Ulteriori finiture decorative e colori RAL disponibili da pagina 76/79. \*\*For other decorative finishing and RAL colours available, see from page 76/79.  
\*\*\*Il flusso effettivo potrebbe avere una tolleranza del ±10%. / \*\*\*The effective flux could have a tolerance of ±10%.

## ESEMPI DI CONFIGURAZIONE CONFIGURATION EXAMPLES

Le dotazioni impiantistiche dei seguenti modelli sono a titolo esemplificativo. I dispositivi della serie AUXILIA possono essere configurati con caratteristiche differenti in base alle esigenze impiantistiche. Per specifiche richieste vi preghiamo di contattare il nostro ufficio commerciale.  
These following versions are illustrative examples. AUXILIA devices can be custom-made according to technical exigencies.  
For specific needs, please contact our Sales Department.

### AUXILIA L

REGOLAMENTO (UE) 2017/745  
REGULATION (EU) 2017/745

PESO [Kg/ml]:  
WEIGHT [Kg/ml]:

INSTALLAZIONE  
INSTALLATION

IDONEO PER  
SUITABLE FOR



Parete - orizzontale  
Wall - horizontal

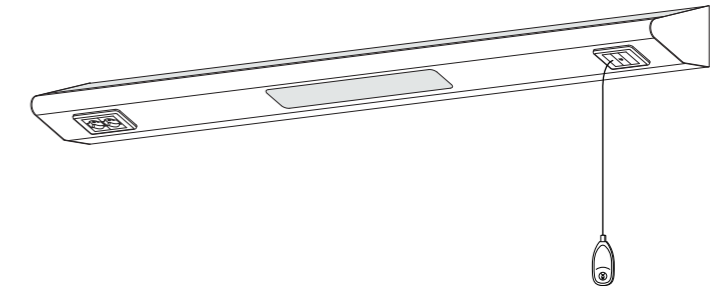
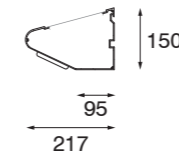

### AUXILIA LD

REGOLAMENTO (UE) 2017/745  
REGULATION (EU) 2017/745

PESO [Kg/ml]:  
WEIGHT [Kg/ml]:

INSTALLAZIONE  
INSTALLATION

IDONEO PER  
SUITABLE FOR



Parete - orizzontale  
Wall - horizontal

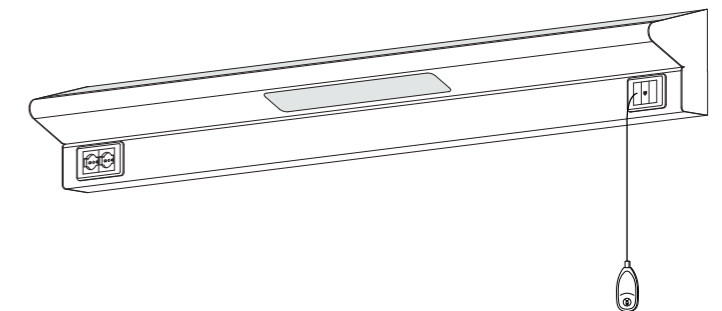
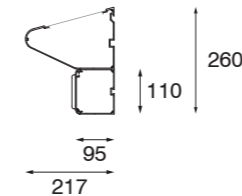

### AUXILIA LDG

REGOLAMENTO (UE) 2017/745  
REGULATION (EU) 2017/745

PESO [Kg/ml]:  
WEIGHT [Kg/ml]:

INSTALLAZIONE  
INSTALLATION

IDONEO PER  
SUITABLE FOR



Parete - orizzontale  
Wall - horizontal

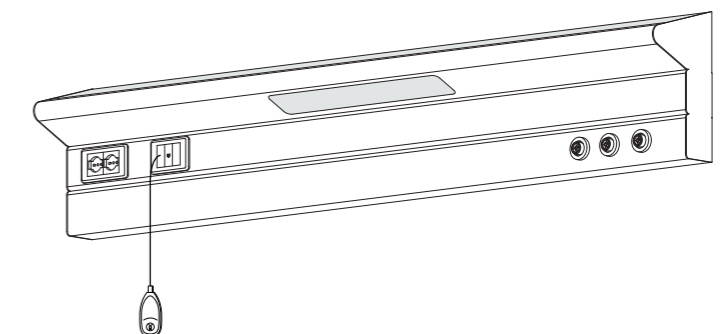
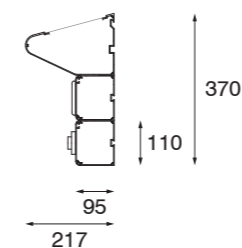

# RIANIMAZIONE E UNITÀ DI TERAPIA INTENSIVA

## INTENSIVE CARE UNIT

Le dotazioni impiantistiche dei seguenti modelli sono a titolo esemplificativo. I dispositivi della serie AUXILIA possono essere configurati con caratteristiche differenti in base alle esigenze impiantistiche. Per specifiche richieste vi preghiamo di contattare il nostro ufficio commerciale. *These following versions are illustrative examples. AUXILIA devices can be custom-made according to technical exigencies. For specific needs, please contact our Sales Department.*

### AUXILIA LDG.2

REGOLAMENTO (UE) 2017/745  
REGULATION (EU) 2017/745

PESO [Kg/ml]:  
WEIGHT [Kg/ml]:

INSTALLAZIONE  
INSTALLATION

IDONEO PER  
SUITABLE FOR

GRUPPO  
GROUP  
2

CLASSE  
CLASS  
IIa / IIb



Parete - orizzontale  
Wall - horizontal

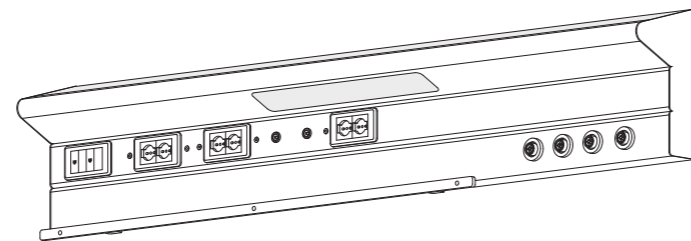
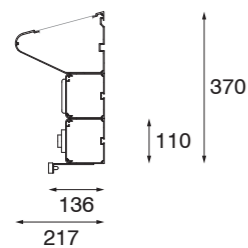

### AUXILIA LDGS.2

REGOLAMENTO (UE) 2017/745  
REGULATION (EU) 2017/745

INSTALLAZIONE  
INSTALLATION

IDONEO PER  
SUITABLE FOR

GRUPPO  
GROUP  
2

CLASSE  
CLASS  
IIa / IIb



Sospensione  
Suspension

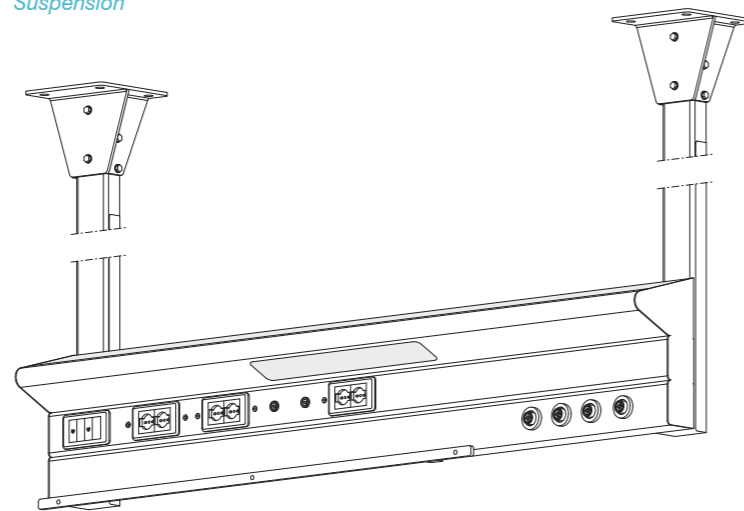
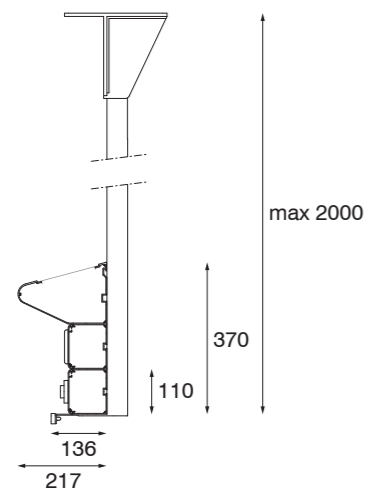

# SENSE

Trave testaletto ad un solo canale in grado di integrare al suo interno tutte le utenze e gli accessori. Composta da un **profilo elegante e minimale**, SENSE assicura funzionalità agli operatori sanitari durante lo svolgimento delle loro mansioni senza trascurare la comodità di avere tutto a portata di mano per il paziente, il quale si sentirà autonomo e rilassato durante la propria permanenza nella struttura.

*One channel bedhead unit realized with a compact design able to integrate all the utilities and accessories inside. SENSE is composed by a **minimal and elegant profile** assuring functionality to the medical staff during their routine activities and, at the same time, taking care of the patients comfort so that they can feel independent and relaxed during their stay.*

- > **SENSE**
- > **SENSE G**

## CLASSIFICAZIONE SECONDO REGOLAMENTO (UE) 2017/745 CLASSIFICATION ACCORDING TO THE REGULATION (EU) 2017/745

- > Classe I (senza gas) - IIa/IIb (con gas)
- > Funzionamento continuo
- > Senza parti applicate
- > Installabile in locali per uso medico di gruppo 0, 1 e 2
- > Non idoneo per essere installato in ambienti con rischio esplosione (presenza di gas e vapori infiammabili)
- > Non installabile in ambienti ricchi di ossigeno con concentrazione superiore al 25% con una pressione ambientale sino a 110 kPa in condizioni normali
- > Non idoneo alle prescrizioni relative alle categorie AP e APG
- > *I class (no gas) - IIa/IIb (with gas)*
- > *Non-stop operation*
- > *No sections are applied*
- > *Suitable for the installation in group 0, 1 and 2 medical premises*
- > *Not suitable for the installation in explosion risk environments (locations with gases and flammable vapours)*
- > *Not suitable for the installation in environments with an oxygen amount superior to the 25% with an environmental pressure until the 110kPa in usual circumstances*
- > *Not suitable for the categories AP and APG provisions*







## DIRETTIVE E NORMATIVE DI RIFERIMENTO REFERENCE DIRECTIVES AND REGULATIONS

(EU) 2017/745  
UNI EN ISO 11197  
CEI EN 60601-1  
CEI EN 60598  
CEI EN 55015  
CEI EN 61547  
UNI CEI EN ISO 14971  
UNI CEI EN ISO 13485

# SENSE



## CARATTERISTICHE GENERALI GENERAL FEATURES

CORPO / <i>BODY</i>	Estruso in alluminio <i>Extruded aluminium</i>	  
OTTICA / <i>DIFFUSER</i>	Policarbonato opale per luce lettura/visita Metacrilato opale per luce ambiente <i>Opal polycarbonate diffuser for reading/examination lighting Opal methacrylate diffuser for general lighting</i>	
LUNGHEZZA MASSIMA* <i>MAXIMUM LENGTH*</i>	3700 mm <i>3700 mm</i>	
GRADO IP / <i>PROTECTION DEGREE</i>	 generale  circuito di illuminazione  prese elettriche <i>general lighting circuit electrical sockets</i>	
COLORE STANDARD** / <i>STANDARD COLOUR**</i>	RAL 9010 Opaco <i>Opaque RAL 9010</i>	
TRATTAMENTO SUPERFICIALE A RICHIESTA <i>SURFACE TREATMENT ON REQUEST</i>	Anodizzazione, verniciatura anti-microbica, finitura decorativa <i>Anodization, antimicrobial coating, decorative finishing</i>	

## CARATTERISTICHE ILLUMINOTECNICHE LIGHTING FEATURES



Potenza <i>Power</i> [W]		Temp. colore <i>Colour Temp.</i> [K]	IRC <i>CRI</i>	Flusso lum.*** <i>Lum. flux***</i> [lm]		Efficienza lum. <i>Lum. effic.</i> [lm / W]	Dimensioni/ <i>Dimensions</i> [mm]					
				↑	↓		A	B	h			
↑26 ↓13	2	3000	>90	↑3159	↓1123	279	↑122	↓86	140	195	1200	121
↑26 ↓13	2	4000	>90	↑3848	↓1344	279	↑148	↓103	140	195	1200	121
↑48 ↓26	2	3000	>90	↑5875	↓2246	279	↑122	↓86	140	195	1200	121
↑48 ↓26	2	4000	>90	↑7104	↓2688	279	↑148	↓103	140	195	1200	121
↑32 ↓13	2	3000	>90	↑3904	↓1123	279	↑122	↓86	140	195	1200	121
↑32 ↓13	2	4000	>90	↑4736	↓1344	279	↑148	↓103	140	195	1200	121
↑32 ↓26	2	3000	>90	↑3904	↓2246	279	↑122	↓86	140	195	1500	121
↑32 ↓26	2	4000	>90	↑4725	↓2688	279	↑148	↓103	140	195	1500	121
↑60 ↓13	2	3000	>90	↑7344	↓1123	279	↑122	↓86	140	195	1500	121
↑60 ↓13	2	4000	>90	↑8880	↓1344	279	↑148	↓103	140	195	1500	121
↑60 ↓26	2	3000	>90	↑7344	↓2246	279	↑122	↓86	140	195	1500	121
↑60 ↓26	2	4000	>90	↑8880	↓2688	279	↑148	↓103	140	195	1500	121

\*Lunghezza riferita alla lavorazione in un unico pezzo. *\*Length referred to a single-block version.*  
 \*\*Ulteriori finiture decorative e colori RAL disponibili da pagina 76/79. *\*\*For other decorative finishing and RAL colours available, see from page 76/79.*  
 \*\*\*Il flusso effettivo potrebbe avere una tolleranza del ±10%. *\*\*\*The effective flux could have a tolerance of ±10%.*

## ESEMPI DI CONFIGURAZIONE CONFIGURATION EXAMPLES

Le dotazioni impiantistiche dei seguenti modelli sono a titolo esemplificativo. I dispositivi della serie SENSE possono essere configurati con caratteristiche differenti in base alle esigenze impiantistiche. Per specifiche richieste vi preghiamo di contattare il nostro ufficio commerciale. *These following versions are illustrative examples. SENSE devices can be custom-made according to technical exigencies. For specific needs, please contact our Sales Department.*

### SENSE

REGOLAMENTO (UE) 2017/745  
*REGULATION (EU) 2017/745*

PESO [Kg/ml]:  
*WEIGHT [Kg/ml]:*

INSTALLAZIONE  
*INSTALLATION*

IDONEO PER  
*SUITABLE FOR*



Parete - orizzontale  
*Wall - horizontal*

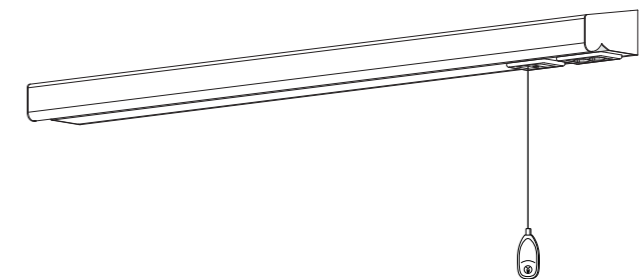
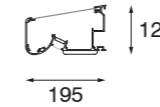

### SENSE G

REGOLAMENTO (UE) 2017/745  
*REGULATION (EU) 2017/745*

PESO [Kg/ml]:  
*WEIGHT [Kg/ml]:*

INSTALLAZIONE  
*INSTALLATION*

IDONEO PER  
*SUITABLE FOR*



Parete - orizzontale  
*Wall - horizontal*

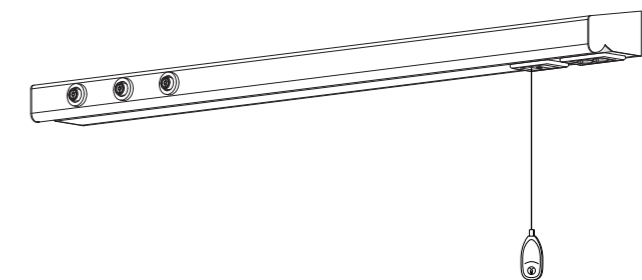
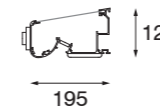



# SANIMED / SANITECH SYSTEM

Concepito per essere un sistema del tutto personalizzabile, la **trave testaletto verticale** SANIMED può essere integrata a corpi illuminanti a parete. Questo sistema combina con efficienza e funzionalità tutti i principali servizi medicali necessari al personale sanitario e le utenze indispensabili per il benessere del paziente. La possibilità di customizzazione delle finiture rende SANITECH SYSTEM un prodotto moderno, in grado di integrarsi perfettamente con la camera di degenza e portare colore e modernità negli ambienti ospedalieri.

*Designed to be a completely customizable system, the vertical bedhead unit SANIMED can combine the wall-mounted lighting fittings. This system combines efficiency and functionality all the main medical services necessary to medical staff and the indispensable functions for the patient's comfort. The possibility of having customized finishings makes SANITECH SYSTEM a modern product suitable for a perfect integration with the patient room, giving color and style to hospital places.*

#### CLASSIFICAZIONE SECONDO REGOLAMENTO (UE) 2017/745 CLASSIFICATION ACCORDING TO THE REGULATION (EU) 2017/745

- > Classe I (senza gas) - IIa/IIb (con gas)
- > Funzionamento continuo
- > Senza parti applicate
- > Installabile in locali per uso medico di gruppo 0, 1 e 2
- > Non idoneo per essere installato in ambienti con rischio esplosione (presenza di gas e vapori infiammabili)
- > Non installabile in ambienti ricchi di ossigeno con concentrazione superiore al 25% con una pressione ambientale sino a 110 kPa in condizioni normali
- > Non idoneo alle prescrizioni relative alle categorie AP e APG
- > I class (no gas) - IIa/IIb (with gas)
- > Non-stop operation
- > No sections are applied
- > Suitable for the installation in group 0, 1 and 2 medical premises
- > Not suitable for the installation in explosion risk environments (locations with gases and flammable vapours)
- > Not suitable for the installation in environments with an oxygen amount superior to the 25% with an environmental pressure until the 110kPa in usual circumstances
- > Not suitable for the categories AP and APG provisions

#### DIRETTIVE E NORMATIVE DI RIFERIMENTO REFERENCE DIRECTIVES AND REGULATIONS

(EU) 2017/745  
UNI EN ISO 11197  
CEI EN 60601-1  
CEI EN 55015  
CEI EN 61547  
UNI CEI EN ISO 14971  
UNI CEI EN ISO 13485

# SANIMED



## CARATTERISTICHE GENERALI GENERAL FEATURES

CORPO / BODY

Struttura portante in acciaio e pannello frontale in MDF

Supporting structure made of steel and frontal panel made of MDF

ALTEZZA MASSIMA  
MAXIMUM HEIGHT

2000 mm

2000 mm

GRADO IP / PROTECTION DEGREE

IP20 generale  
IP40 circuito di illuminazione  
IP21 prese elettriche

IP20 general  
IP40 lighting circuit  
IP21 electrical sockets

COLORE STANDARD\*\* / STANDARD COLOUR\*\*

RAL 9010 opaco bianco

Opaque RAL 9010 white

TRATTAMENTO SUPERFICIALE A RICHIESTA  
SURFACE TREATMENT ON REQUEST

Anodizzazione,  
verniciatura anti-microbica,  
finitura decorativa

Anodization,  
antimicrobial coating,  
decorative finishing



\*\*Ulteriori finiture decorative e colori RAL disponibili da pagina 76/79. \*\*For other decorative finishing and RAL colours available, see from page 76/79.

## ESEMPI DI CONFIGURAZIONE CONFIGURATION EXAMPLES

Le dotazioni impiantistiche dei seguenti modelli sono a titolo esemplificativo. I dispositivi della serie SANIMED possono essere configurati con caratteristiche differenti in base alle esigenze impiantistiche. Per specifiche richieste vi preghiamo di contattare il nostro ufficio commerciale. These following versions are illustrative examples. SANIMED devices can be custom-made according to technical exigencies. For specific needs, please contact our Sales Department.

### SANIMED

REGOLAMENTO (UE) 2017/745  
REGULATION (EU) 2017/745

GRUPPO GROUP 0 / 1  
CLASSE CLASS I

PESO [Kg/ml]:  
WEIGHT [Kg/ml]:



INSTALLAZIONE  
INSTALLATION

Parete - verticale  
Wall - vertical

POSTI LETTO  
BEDS



IDONEO PER  
SUITABLE FOR

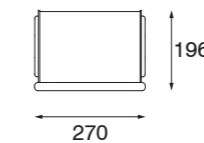
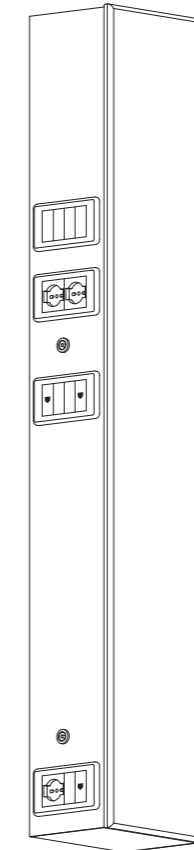

### SANIMED G

REGOLAMENTO (UE) 2017/745  
REGULATION (EU) 2017/745

GRUPPO GROUP 0 / 1  
CLASSE CLASS IIa / IIb

PESO [Kg/ml]:  
WEIGHT [Kg/ml]:



INSTALLAZIONE  
INSTALLATION

Parete - verticale  
Wall - vertical

POSTI LETTO  
BEDS



IDONEO PER  
SUITABLE FOR

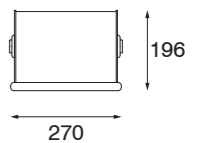
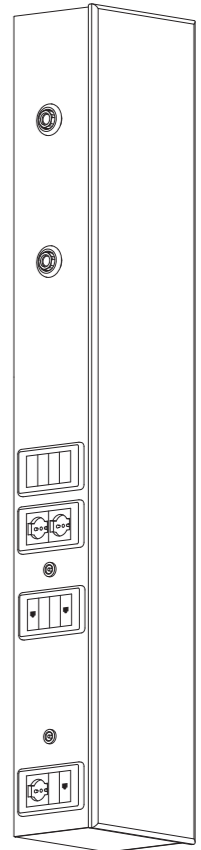

Degenza  
Patient room



Terapia Intensiva  
Intensive care



Laboratorio  
Laboratory

# SISTEMI ELETTROMEDICALI: SANITECH SYSTEM

## ELECTROMEDICAL SYSTEMS: SANITECH SYSTEM

I sistemi elettromedicali di ATENA LUX vengono realizzati qualora ci sia una **specifica esigenza tecnica e architettonica** della committenza. Il progetto si sviluppa secondo le linee guida dettate dalla normativa di riferimento e dà vita ad un **sistema certificato**. Gli elementi che compongono questi complessi sistemi medicali sono realizzati con particolare attenzione all'estetica, all'ergonomia e al benessere del paziente.

La trave testataletto verticale SANIMED, le cui utenze sono poste in un solo lato oppure in entrambi i lati, può essere combinata con un'applicazione d'illuminazione appositamente realizzata su misura. Per integrare questi elementi al meglio, rimanendo in linea con i canoni architettonici richiesti dalla committenza, si ricorre all'utilizzo di materiali diversi, quali per esempio il legno MDF che offre un ampio ventaglio di soluzioni e finiture. Il corpo illuminante è studiato in modo tale da diffondere una luce generale indiretta per un'atmosfera stimolante, una luce individuale per la lettura e per le visite mediche e un'illuminazione notturna. La finitura in legno MDF riprende lo stesso rivestimento decorativo della trave testataletto.



ATENA LUX realize custom-made electromedical systems when the customer has a **specific technical and architectural requirement**. The project is developed according to the guidelines dictated by the reference normative and gives life to a **certified system**. The elements composing this system are realized with particular attention to aesthetics, ergonomics and patient well-being.

The SANIMED vertical bed head unit, whose outlets are located on one side or on both sides, can be combined with a custom-made lighting applique. In order to remaining in line with the architectural standards required by the client, bedhead unit and lights are integrated using different materials, such as MDF wood, which offers a wide range of solutions and finishes. The lighting fitting is designed in such a way as to diffuse and indirect general light creating a relaxing atmosphere, an individual light for reading and for medical examination and night light. The MDF wood panel has the same finishing of the bedhead unit decorative covering.

## ALTRE POSSIBILI CONFIGURAZIONI\* CONFIGURATIONS WITH LIGHTING\*

### SANIMED + AIRWALL

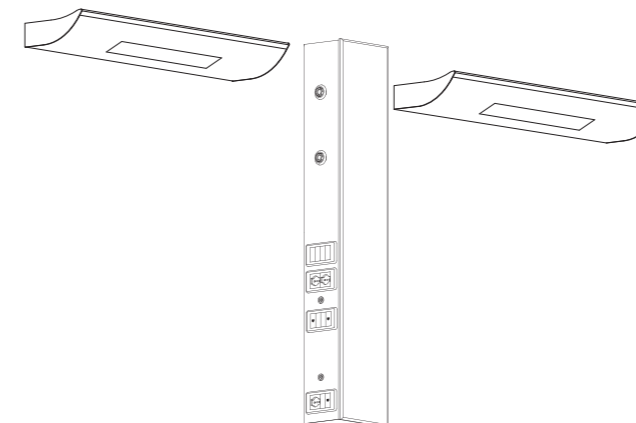

Mentre la trave testataletto verticale eroga tutte le funzioni di distribuzione elettrica e gas medicali, il corpo illuminante AIRWALL, con il suo design morbido e innovativo, mantiene una condizione di luce confortevole per il paziente e allo stesso tempo idonea alle attività del personale sanitario. Pur essendo un apparecchio compatto, AIRWALL può essere dotata di una luce generale di bassa intensità, una luce lettura che non genera abbagliamenti, una luce notturna e una luce visita.

*While the vertical bedhead unit meets the needs of electrical distribution and medical gases, the AIRWALL lighting fixture, with its soft and innovative design, maintains a light condition that is comfortable for the patient and at the same time suitable for carrying on the activities of the hospital staff. Thanks to its compact body, AIRWALL can be equipped with a low intensity general light, a no-glare reading light, night light and examination light.*

### SANIMED + STAIR CARE

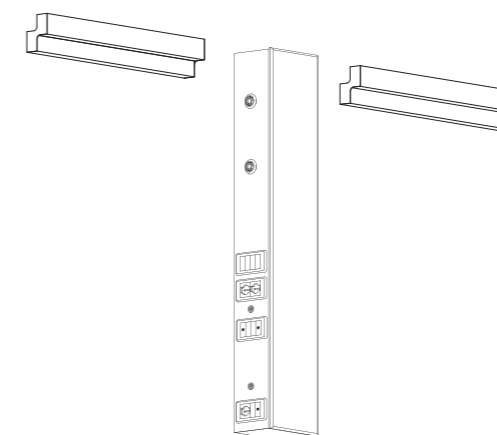

Una soluzione più lineare e tecnica e rappresentata dall'accostamento della trave testataletto verticale con l'applicazione di illuminazione STAIR PLUS. Questa lampada, in cui luce diretta e indiretta vengono gestite separatamente, può essere dotata anche di una pulsantiera pensile per la chiamata infermiera ed eventuale gestione della luce diretta. Grazie al suo design raffinato e moderno, è la perfetta combinazione delle sue ottime performance illuminotecniche alle esigenze estetiche e architettoniche dell'ambiente.

*The combination of the vertical bedhead unit with the STAIR PLUS lighting applique represents a more linear and technical solution. This lamp, in which direct light and indirect light are managed separately, can also be equipped with a hanging keyboard for the nurse call and also the management of direct light. Thanks to its refined and modern design, it is the perfect combination of its excellent lighting performance to the aesthetic and architectural needs of the environment.*

### SANIMED + WAY WALL

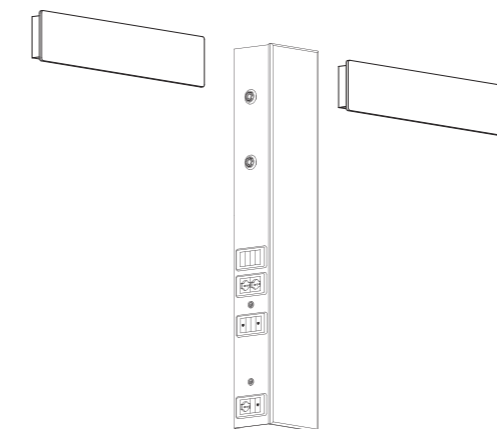

Grazie alla libertà creativa e decorativa di WAY WALL, questa combinazione rende possibile una personalizzazione della sala di degenza. Realizzata da un doppio profilo estruso d'alluminio, dalle dimensioni ridotte, può dare carattere all'ambiente grazie all'applicazione di un pannello decorativo realizzato in legno MDF. Una soluzione semplice ma di impatto che garantisce una luce pulita e in grado di soddisfare le esigenze illuminotecniche della stanza di degenza.

*Thanks to its creative and decorative flexibility, WAY WALL enables to personalize the patient's room with style. Made of a double extruded aluminum profile, with reduced dimensions, can be personalized applying on the surface a decorative panel made of MDF wood, giving character to the environment. A simple and fresh solution that guarantees a soft light able to meet the lighting requirements of the patient room.*

\*Maggiori informazioni sui corpi illuminanti disponibili da pagina 60  
\*For more information about our lighting solutions, please read from page 60

# ARMONIA

ARMONIA è un **pannello multifunzionale** progettato per essere un valido elemento d'illuminazione medicale, presentando le caratteristiche di un complemento d'arredo dal design personalizzabile e dalle finiture eleganti. ARMONIA garantisce un adeguato livello d'illuminazione all'interno della stanza e grazie all'implementazione degli impianti per i gas medicinali diventa il prodotto ideale per chi desidera rinnovare l'ambiente ospedaliero.

*ARMONIA is a **multifunctional panel** realized as a valid medical lighting element with the features of a furnishing accessory, with custom design and elegant finishing. ARMONIA guarantees the perfect lighting level inside the room, and thanks to the implementation of the medical gases systems, it becomes a perfect solution for those who want to renovate the hospital environment.*

## CLASSIFICAZIONE SECONDO REGOLAMENTO (UE) 2017/745 CLASSIFICATION ACCORDING TO THE REGULATION (EU) 2017/745

- > Classe I (senza gas) - IIa/IIb (con gas)
- > Funzionamento continuo
- > Senza parti applicate
- > Installabile in locali per uso medico di gruppo 0, 1 e 2
- > Non idoneo per essere installato in ambienti con rischio esplosione (presenza di gas e vapori infiammabili)
- > Non installabile in ambienti ricchi di ossigeno con concentrazione superiore al 25% con una pressione ambientale sino a 110 kPa in condizioni normali
- > Non idoneo alle prescrizioni relative alle categorie AP e APG
- > I class (no gas) - IIa/IIb (with gas)
- > Non-stop operation
- > No sections are applied
- > Suitable for the installation in group 0, 1 and 2 medical premises
- > Not suitable for the installation in explosion risk environments (locations with gases and flammable vapours)
- > Not suitable for the installation in environments with an oxygen amount superior to the 25% with an environmental pressure until the 110kPa in usual circumstances
- > Not suitable for the categories AP and APG provisions

## DIRETTIVE E NORMATIVE DI RIFERIMENTO REFERENCE DIRECTIVES AND REGULATIONS

(EU) 2017/745  
UNI EN ISO 11197  
CEI EN 60601-1  
CEI EN 60598  
CEI EN 55015  
CEI EN 61547  
CEI EN 62471  
UNI CEI EN ISO 14971  
UNI CEI EN ISO 13485

# ARMONIA

## CARATTERISTICHE GENERALI GENERAL FEATURES

CORPO / BODY	Struttura portante in acciaio, pannelli frontali in MDF	Steel supporting structure and MDF frontal panels												
OTTICA / DIFFUSER	Metacrilato opale per luce lettura/visita Policarbonato opale per luce ambiente	Opal methacrylate diffuser for reading/examination lighting Opal polycarbonate diffuser for general lighting												
LUNGHEZZA MASSIMA* MAXIMUM LENGTH*	2700 mm	2700 mm												
GRADO IP / PROTECTION DEGREE	<table border="0"> <tr><td>IP20</td><td>generale</td></tr> <tr><td>IP40</td><td>circuito di illuminazione</td></tr> <tr><td>IP21</td><td>prese elettriche</td></tr> </table>	IP20	generale	IP40	circuito di illuminazione	IP21	prese elettriche	<table border="0"> <tr><td>IP20</td><td>general</td></tr> <tr><td>IP40</td><td>lighting circuit</td></tr> <tr><td>IP21</td><td>electrical sockets</td></tr> </table>	IP20	general	IP40	lighting circuit	IP21	electrical sockets
IP20	generale													
IP40	circuito di illuminazione													
IP21	prese elettriche													
IP20	general													
IP40	lighting circuit													
IP21	electrical sockets													
COLORE STANDARD** / STANDARD COLOUR**	RAL 9010 Opaco	Opaque RAL 9010												
TRATTAMENTO SUPERFICIALE A RICHIESTA SURFACE TREATMENT ON REQUEST	Anodizzazione, verniciatura anti-microbica, finitura decorativa	Anodization, antimicrobial coating, decorative finishing												



## CARATTERISTICHE ILLUMINOTECNICHE LIGHTING FEATURES



Potenza Power [W]	Temp. colore Colour Temp. [K]	IRC CRI	Flusso lum. *** Lum. flux *** [lm]		Efficienza lum. Lum. effic. [lm / W]		Dimensioni/Dimensions [mm]			
			↑3103 ↓1800	242	↑107 ↓100	121	A	B	h	
↑29 ↓18	2	3000	>90	↑3103 ↓1800	242	↑107 ↓100	121	136	1400	2500
↑29 ↓18	2	4000	>90	↑4095 ↓2322	242	↑141 ↓129	121	136	1400	2500
↑41 ↓29	2	3000	>90	↑4387 ↓2900	242	↑107 ↓100	121	136	1400	2500
↑41 ↓29	2	4000	>90	↑5781 ↓3727	242	↑141 ↓129	121	136	1400	2500

\*Dimensione riferita alla lavorazione di un pezzo unico. \*Size refers to the processing of a single piece.  
\*\*Ulteriori finiture decorative e colori RAL disponibili da pagina 76/79. \*\*For other decorative finishings and RAL colours available, see from page 76/79.  
\*\*\*Il flusso effettivo potrebbe avere una tolleranza del ±10%. / \*\*\*The effective flux could have a tolerance of ±10%.

I prodotti della serie Armonia non sono destinati al territorio della Germania.  
Armonia devices are not intended for the German market.



## ILLUMINAZIONE LIGHTING

ARMONIA è in grado di fornire **luce ambiente, luce visita/lettura e luce notturna**. Per la luce visita è prevista l'accensione totale dei LED, mentre la luce lettura viene predefinita tramite un sistema di commutazione che riduce la potenza e conseguentemente il flusso luminoso.  
La luce generale indiretta viene invece gestita separatamente e permette di illuminare completamente la stanza di degenza.

ARMONIA has the **ambiance, reading and the examination light**. The examination light needs the complete power of the LEDs while the reading light is settled by an electronic switching system that reduces the power and, as a consequence, the luminous flux of LEDs. The indirect general light is controlled separately and enables to completely illuminate the patient room.

## FINITURA FINISHING

ARMONIA ha una struttura in acciaio verniciato e dei pannelli frontali in **MDF** rimovibili per garantire l'ispezionabilità interna. Questi pannelli sono dotati di **certificazione di resistenza al fuoco** e di **idrorepellenza**, svolgono una funzione tecnica per nascondere i cablaggi ed una funzione estetica, caratterizzando l'ambiente. Oltre alle tradizionali tinte RAL, su richiesta sono disponibili finiture in legno naturale per la loro decorazione.

Grazie ai materiali particolari utilizzati per la sua produzione, ARMONIA risulta un prodotto durevole nel tempo e adatto all'installazione in ambienti dove l'igiene e la praticità hanno primaria importanza.

ARMONIA is made of a painted steel structure and frontal panels made of **MDF** material, removable to guarantee internal inspection. These panels are **fire resistant certified** and **waterproof** and have the function of masking the wiring and the aesthetical function of characterizing the medical environment. On request, in addition to the traditional RAL colors, other wood finishing are available.

Thanks to the particular materials used for its production, ARMONIA results a long lasting product, suitable for the installation in places where hygiene and practicality are the main exigencies.

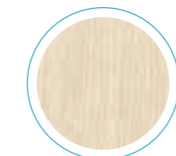

Rovere  
Durmast

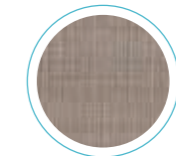

Promenade  
Promenade

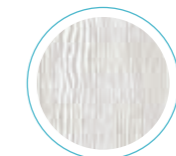

Larice  
Larch

## ESEMPI DI CONFIGURAZIONE CONFIGURATION EXAMPLES

Le caratteristiche dimensionali relative a un testata letto di lunghezza 1400 mm per 1 posto letto.  
Le dotazioni impiantistiche dei seguenti modelli sono a titolo esemplificativo. I dispositivi della serie ARMONIA possono essere configurati con caratteristiche differenti in base alle esigenze impiantistiche. Per specifiche richieste vi preghiamo di contattare il nostro ufficio commerciale.  
*Dimensional characteristics relating to one bed bedhead unit, 1400 mm long.  
ARMONIA devices can be custom-made according to technical exigencies.  
For specific needs, please contact our Sales Department.*

### ARMONIA

REGOLAMENTO (UE) 2017/745  
REGULATION (EU) 2017/745

GRUPPO  
GROUP  
0 / 1

CLASSE  
CLASS  
I

PESO  
WEIGHT



INSTALLAZIONE  
INSTALLATION



POSTI LETTO  
BEDS



IDONEO PER  
SUITABLE FOR

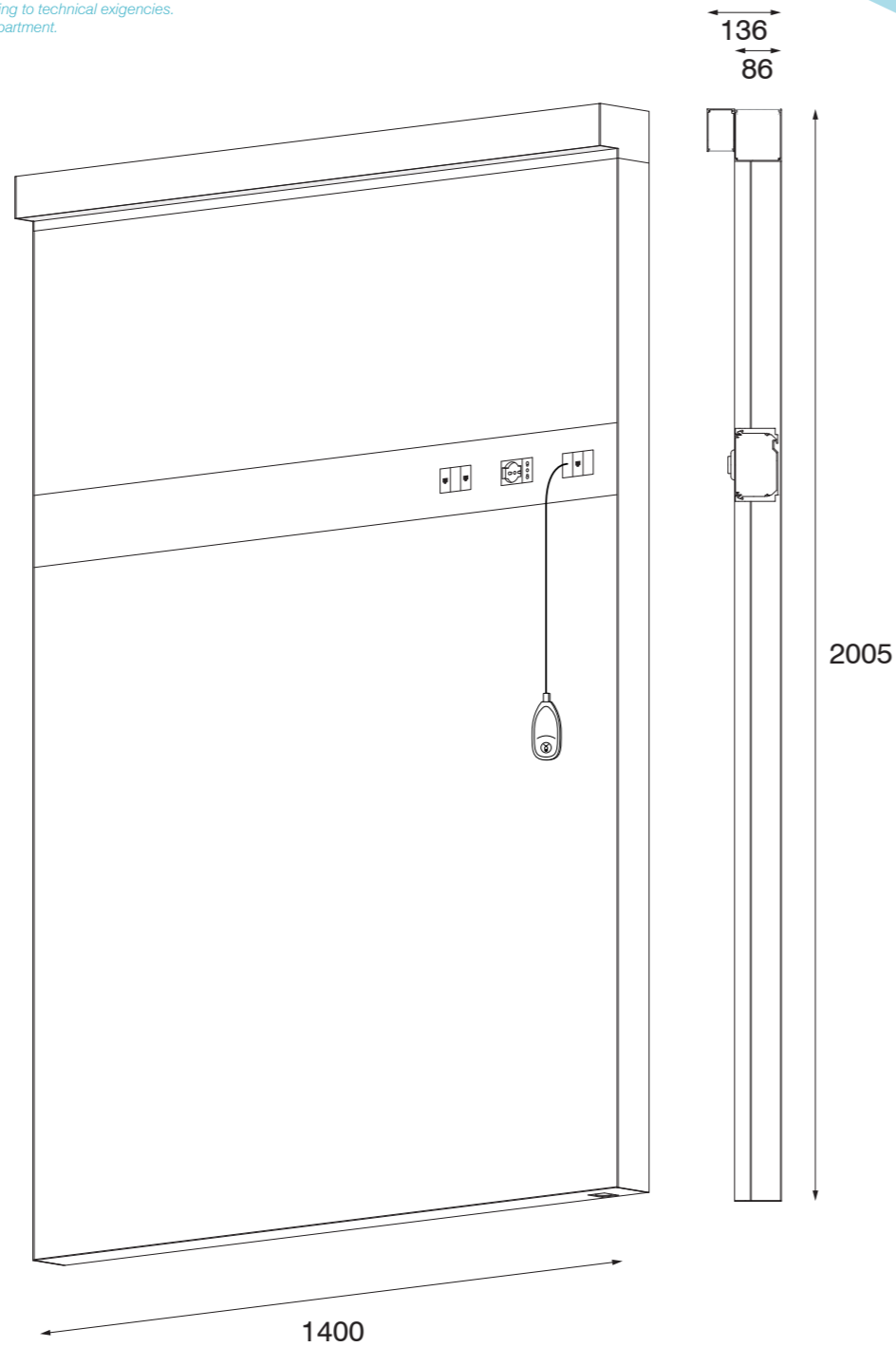

### ARMONIA G

REGOLAMENTO (UE) 2017/745  
REGULATION (EU) 2017/745

GRUPPO  
GROUP  
0 / 1

CLASSE  
CLASS  
IIa / IIb

PESO  
WEIGHT



INSTALLAZIONE  
INSTALLATION



POSTI LETTO  
BEDS



IDONEO PER  
SUITABLE FOR

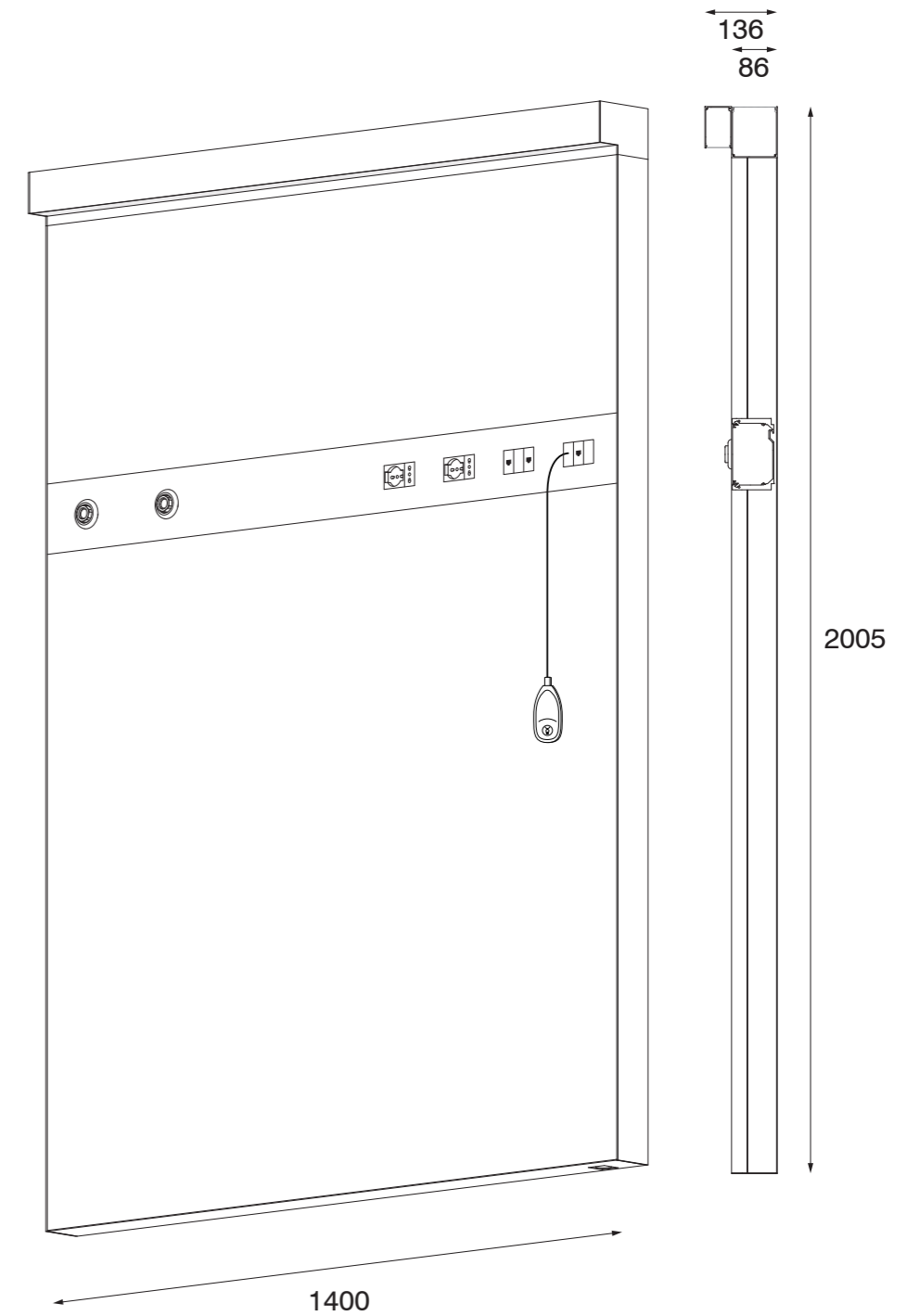

# THERAPY

THERAPY sfrutta al massimo lo spazio e consente una disposizione ordinata delle apparecchiature attorno al posto letto, garantendo l'erogazione dei **gas medicinali** e dell'**energia elettrica**, con la possibilità di integrarla ulteriormente, su richiesta del cliente. Questo dispositivo è idoneo all'installazione in locali medici di **gruppo 2** quali sale per anestesia, chirurgia, cure intensive, per esami angiografici ed emodinamici.

*THERAPY gets the most from space and allows a tidy disposition of the medical equipment around the bed, supplying **medical gases** and **electricity**. On request, it is possible to further integrate it. This device is suitable for the installation in medical places of the **group 2** such as anesthesia room, surgery room, intensive care, angiography and hemodynamic examination rooms.*

- › **THERAPY W**
- › **THERAPY S**
- › **THERAPY V**
- › **THERAPY R**

#### CLASSIFICAZIONE SECONDO REGOLAMENTO (UE) 2017/745 CLASSIFICATION ACCORDING TO THE REGULATION (EU) 2017/745

- › Classe I (senza gas) - IIa/IIb (con gas)
- › Funzionamento continuo
- › Senza parti applicate
- › Installabile in locali per uso medico di gruppo 0, 1 e 2
- › Non idoneo per essere installato in ambienti con rischio esplosione (presenza di gas e vapori infiammabili)
- › Non installabile in ambienti ricchi di ossigeno con concentrazione superiore al 25% con una pressione ambientale sino a 110 kPa in condizioni normali
- › Non idoneo alle prescrizioni relative alle categorie AP e APG
- › I class (no gas) - IIa/IIb (with gas)
- › Non-stop operation
- › No sections are applied
- › Suitable for the installation in group 0,1 and 2 medical premises
- › Not suitable for the installation in explosion risk environments (locations with gases and flammable vapours)
- › Not suitable for the installation in environments with an oxygen amount superior to the 25% with an environmental pressure until the 110kPa in usual circumstances
- › Not suitable for the categories AP and APG provisions

#### DIRETTIVE E NORMATIVE DI RIFERIMENTO REFERENCE DIRECTIVES AND REGULATIONS

(EU) 2017/745  
UNI EN ISO 11197  
CEI EN 60601-1  
CEI EN 55015  
CEI EN 61547  
UNI CEI EN ISO 14971  
UNI CEI EN ISO 13485

# THERAPY W

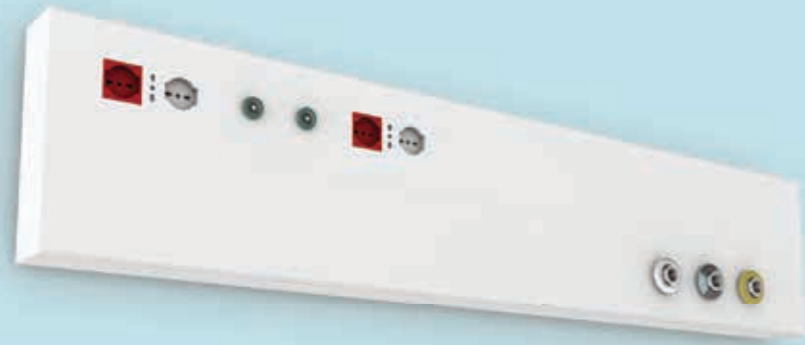

## CARATTERISTICHE GENERALI GENERAL FEATURES

CORPO / BODY	Estruso in alluminio	Extruded aluminium
LUNGHEZZA MASSIMA* / MAXIMUM LENGTH*	3700 mm	3700 mm
GRADO IP / PROTECTION DEGREE	<div style="display: flex; gap: 5px;"> <div style="border: 1px solid black; padding: 2px;">IP20</div> generale             <div style="border: 1px solid black; padding: 2px;">IP40</div> circuito di illuminazione             <div style="border: 1px solid black; padding: 2px;">IP21</div> prese elettriche           </div>	<div style="display: flex; gap: 5px;"> <div style="border: 1px solid black; padding: 2px;">IP20</div> general             <div style="border: 1px solid black; padding: 2px;">IP40</div> lighting circuit             <div style="border: 1px solid black; padding: 2px;">IP21</div> electrical sockets           </div>
COLORE STANDARD** / STANDARD COLOUR**	RAL 9010 Opaco	Opaque RAL 9010
TRATTAMENTO SUPERFICIALE A RICHIESTA SURFACE TREATMENT ON REQUEST	Anodizzazione, verniciatura anti-microbica, finitura decorativa	Anodization, antimicrobial coating, decorative finishing



## CARATTERISTICHE ELETTRICHE ELECTRICAL FEATURES

TENSIONE DI ALIMENTAZIONE / FEEDING TENSION	230V / 50Hz	230V / 50Hz
TENSIONE DI ALIMENTAZIONE AUSILIARI / ADDITIONAL FEEDING TENSION	12V DC	12V DC
POTENZA MASSIMA PRESE ELETTRICHE / MAXIMUM SOCKET POWER	3000W	3000W

\*Lunghezza riferita alla lavorazione in un unico pezzo. \*Length referred to a single-block version.

\*\*Ulteriori finiture decorative e colori RAL disponibili da pagina 76/79. \*\*For other decorative finishing and RAL colours available, see from page 76/79.

## ESEMPI DI CONFIGURAZIONE CONFIGURATION EXAMPLES

Le dotazioni impiantistiche dei seguenti modelli sono a titolo esemplificativo. I dispositivi della serie THERAPY W possono essere configurati con caratteristiche differenti in base alle esigenze impiantistiche. Per specifiche richieste vi preghiamo di contattare il nostro ufficio commerciale. These following versions are illustrative examples. THERAPY W devices can be custom-made according to technical exigencies. For specific needs, please contact our Sales Department.

### THERAPY W

REGOLAMENTO (UE) 2017/745  
REGULATION (EU) 2017/745



PESO [Kg/ml]:  
WEIGHT [Kg/ml]:



INSTALLAZIONE  
INSTALLATION



Parete - orizzontale  
Wall - horizontal

IDONEO PER  
SUITABLE FOR

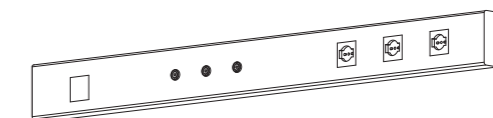
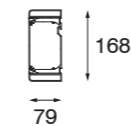

### THERAPY WG

REGOLAMENTO (UE) 2017/745  
REGULATION (EU) 2017/745



PESO [Kg/ml]:  
WEIGHT [Kg/ml]:



INSTALLAZIONE  
INSTALLATION



Parete - orizzontale  
Wall - horizontal

IDONEO PER  
SUITABLE FOR

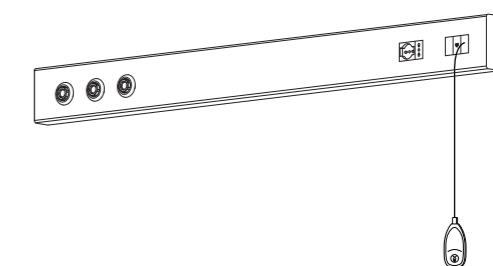
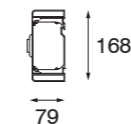



# RIANIMAZIONE E UNITÀ DI TERAPIA INTENSIVA

## INTENSIVE CARE UNIT

Le dotazioni impiantistiche dei seguenti modelli sono a titolo esemplificativo.  
I dispositivi della serie THERAPY W / THERAPY S possono essere configurati con caratteristiche differenti in base alle esigenze impiantistiche.  
Per specifiche richieste vi preghiamo di contattare il nostro ufficio commerciale.  
*These following versions are illustrative examples. THERAPY W / THERAPY S devices can be custom-made according to technical exigencies.  
For specific needs, please contact our Sales Department.*

### THERAPY WG.2

REGOLAMENTO (UE) 2017/745  
REGULATION (EU) 2017/745

GRUPPO  
GROUP  
2

CLASSE  
CLASS  
IIa / IIb

PESO [Kg/ml]:  
WEIGHT [Kg/ml]:



INSTALLAZIONE  
INSTALLATION



Parete - orizzontale  
Wall - horizontal

IDONEO PER  
SUITABLE FOR

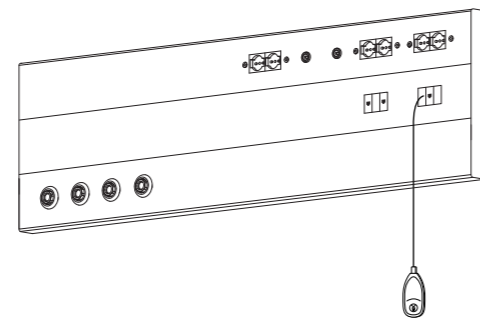
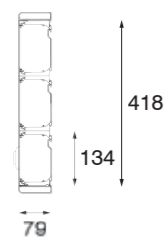

### THERAPY WG.2

REGOLAMENTO (UE) 2017/745  
REGULATION (EU) 2017/745

GRUPPO  
GROUP  
2

CLASSE  
CLASS  
IIa / IIb

PESO [Kg/ml]:  
WEIGHT [Kg/ml]:



INSTALLAZIONE  
INSTALLATION



Parete - orizzontale  
Wall - horizontal

IDONEO PER  
SUITABLE FOR

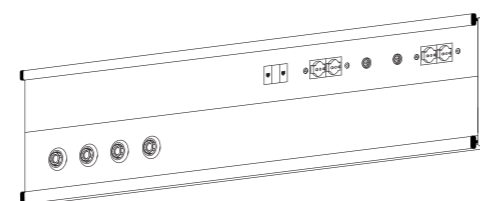
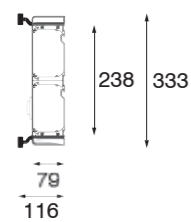

### THERAPY SG.2

REGOLAMENTO (UE) 2017/745  
REGULATION (EU) 2017/745

GRUPPO  
GROUP  
2

CLASSE  
CLASS  
IIa / IIb

INSTALLAZIONE  
INSTALLATION



Parete - orizzontale  
Wall - horizontal

IDONEO PER  
SUITABLE FOR

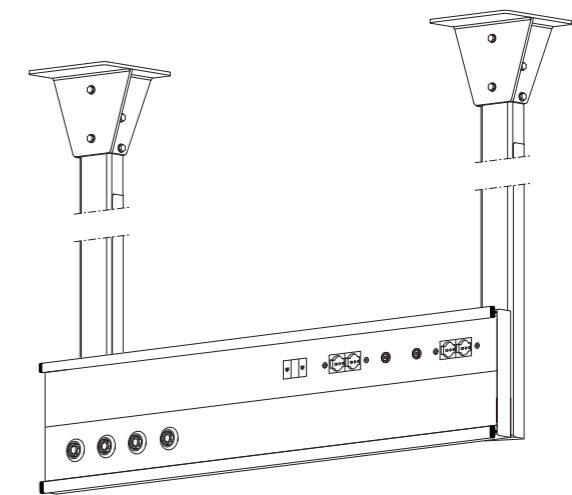
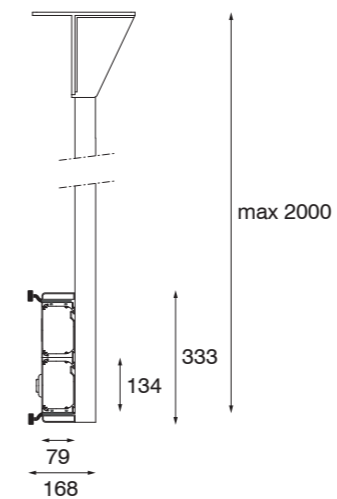

Degenza  
Patient room



Terapia Intensiva  
Intensive care



Laboratorio  
Laboratory

# THERAPY V



## CARATTERISTICHE GENERALI GENERAL FEATURES

CORPO / BODY	Estruso in alluminio	Extruded aluminium
ALTEZZA MASSIMA* MAXIMUM HEIGHT*	3700 mm	3700 mm
GRADO IP / PROTECTION DEGREE	<div style="display: flex; gap: 5px;"> <div style="border: 1px solid black; padding: 2px;">IP20</div> generale             </div> <div style="display: flex; gap: 5px;"> <div style="border: 1px solid black; padding: 2px;">IP40</div> circuito di illuminazione             </div> <div style="display: flex; gap: 5px;"> <div style="border: 1px solid black; padding: 2px;">IP21</div> prese elettriche             </div>	<div style="display: flex; gap: 5px;"> <div style="border: 1px solid black; padding: 2px;">IP20</div> general             </div> <div style="display: flex; gap: 5px;"> <div style="border: 1px solid black; padding: 2px;">IP40</div> lighting circuit             </div> <div style="display: flex; gap: 5px;"> <div style="border: 1px solid black; padding: 2px;">IP21</div> electrical sockets             </div>
COLORE STANDARD** / STANDARD COLOUR**	RAL 9010 Opaco	Opaque RAL 9010
TRATTAMENTO SUPERFICIALE A RICHIESTA SURFACE TREATMENT ON REQUEST	Anodizzazione, verniciatura anti-microbica, finitura decorativa	Anodization, antimicrobial coating, decorative finishing



## CARATTERISTICHE ELETTRICHE ELECTRICAL FEATURES

TENSIONE DI ALIMENTAZIONE / FEEDING TENSION	230V / 50Hz	230V / 50Hz
TENSIONE DI ALIMENTAZIONE AUSILIARI / ADDITIONAL FEEDING TENSION	12V DC	12V DC
POTENZA MASSIMA PRESE ELETTRICHE / MAXIMUM SOCKET POWER	3000W	3000W

\*Altezza riferita alla lavorazione in un unico pezzo. \*Height referred to a single-block version.  
\*\*Ulteriori finiture decorative e colori RAL disponibili da pagina 76/79. \*\*For other decorative finishing and RAL colours available, see from page 76/79.

## ESEMPI DI CONFIGURAZIONE CONFIGURATION EXAMPLES

Le dotazioni impiantistiche dei seguenti modelli sono a titolo esemplificativo. I dispositivi della serie THERAPY V possono essere configurati con caratteristiche differenti in base alle esigenze impiantistiche. Per specifiche richieste vi preghiamo di contattare il nostro ufficio commerciale. These following versions are illustrative examples. THERAPY V devices can be custom-made according to technical exigencies. For specific needs, please contact our Sales Department.

### THERAPY V

REGOLAMENTO (UE) 2017/745  
REGULATION (EU) 2017/745



PESO [Kg/ml]:  
WEIGHT [Kg/ml]:



INSTALLAZIONE  
INSTALLATION



POSTI LETTO  
BEDS



IDONEO PER  
SUITABLE FOR

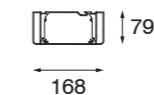
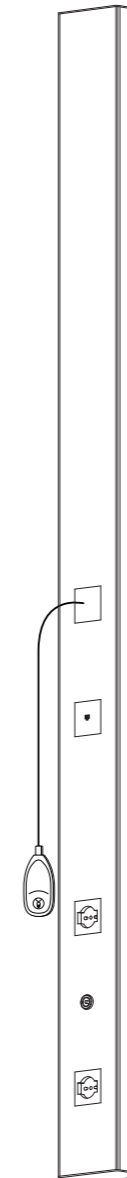

### THERAPY VG

REGOLAMENTO (UE) 2017/745  
REGULATION (EU) 2017/745



PESO [Kg/ml]:  
WEIGHT [Kg/ml]:



INSTALLAZIONE  
INSTALLATION



POSTI LETTO  
BEDS



IDONEO PER  
SUITABLE FOR

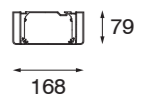
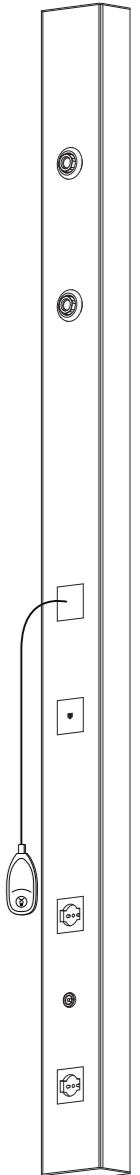

# RIANIMAZIONE E UNITÀ DI TERAPIA INTENSIVA

## INTENSIVE CARE UNIT

Le dotazioni impiantistiche dei seguenti modelli sono a titolo esemplificativo.  
I dispositivi della serie THERAPY V possono essere configurati con caratteristiche differenti in base alle esigenze impiantistiche.  
Per specifiche richieste vi preghiamo di contattare il nostro ufficio commerciale.  
*These following versions are illustrative examples. THERAPY V devices can be custom-made according to technical exigencies.  
For specific needs, please contact our Sales Department.*

### THERAPY VG

REGOLAMENTO (UE) 2017/745  
REGULATION (EU) 2017/745

GRUPPO GROUP 0 / 1  
CLASSE CLASS IIa/IIb

PESO [Kg/m]:  
WEIGHT [Kg/m]:



INSTALLAZIONE  
INSTALLATION



Parete - verticale  
Wall - vertical

POSTI LETTO  
BEDS



IDONEO PER  
SUITABLE FOR

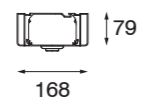
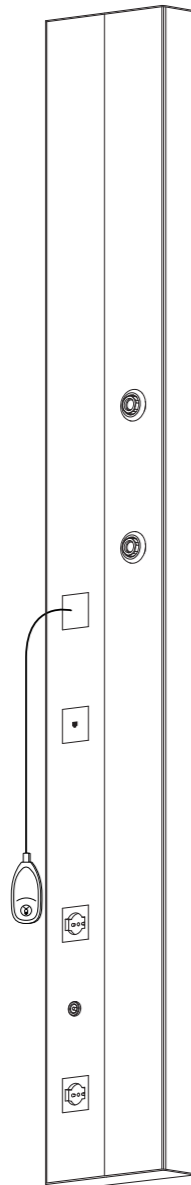

### THERAPY VG

REGOLAMENTO (UE) 2017/745  
REGULATION (EU) 2017/745

GRUPPO GROUP 0 / 1  
CLASSE CLASS IIa/IIb

PESO [Kg/m]:  
WEIGHT [Kg/m]:



INSTALLAZIONE  
INSTALLATION



Parete - verticale  
Wall - vertical

POSTI LETTO  
BEDS



IDONEO PER  
SUITABLE FOR

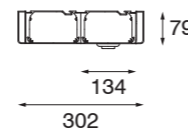
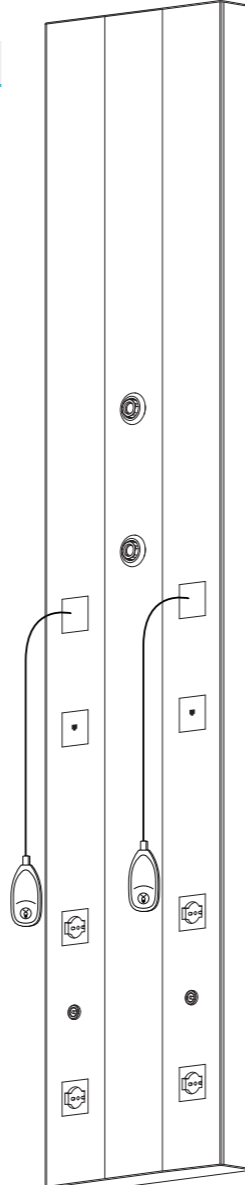

### THERAPY VG.2

REGOLAMENTO (UE) 2017/745  
REGULATION (EU) 2017/745

GRUPPO GROUP 2  
CLASSE CLASS IIa/IIb

PESO [Kg/m]:  
WEIGHT [Kg/m]:



INSTALLAZIONE  
INSTALLATION



Parete - verticale  
Wall - vertical

POSTI LETTO  
BEDS



IDONEO PER  
SUITABLE FOR

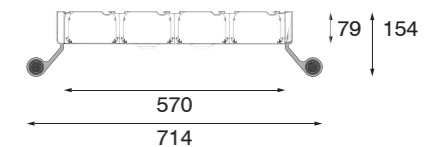
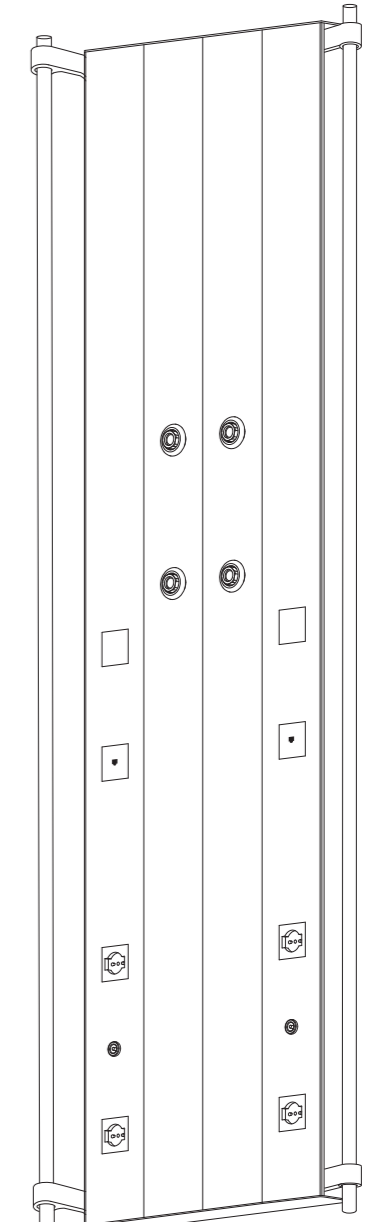
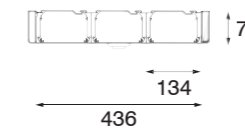
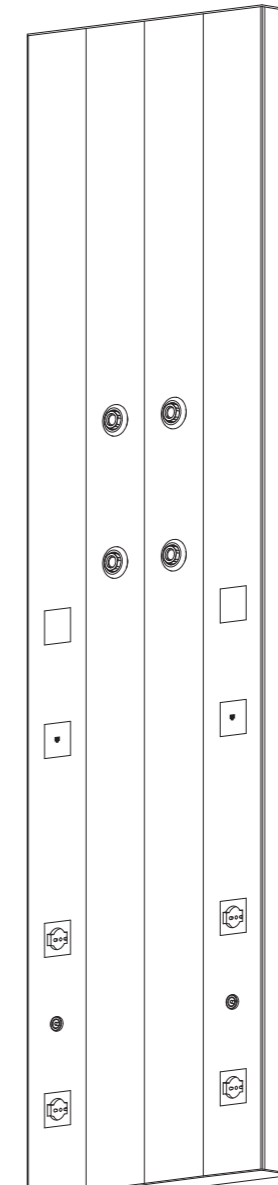

# THERAPY R



## CARATTERISTICHE GENERALI GENERAL FEATURES

CORPO / <i>BODY</i>	Estruso in alluminio	<i>Extruded aluminium</i>
LUNGHEZZA MASSIMA* <i>MAXIMUM LENGTH*</i>	3700 mm	<i>3700 mm</i>
GRADO IP / <i>PROTECTION DEGREE</i>	<div style="display: flex; flex-direction: column; gap: 5px;"> <div><span style="border: 1px solid black; padding: 2px;">IP20</span> generale</div> <div><span style="border: 1px solid black; padding: 2px;">IP40</span> circuito di illuminazione</div> <div><span style="border: 1px solid black; padding: 2px;">IP21</span> prese elettriche</div> </div>	<div style="display: flex; flex-direction: column; gap: 5px;"> <div><span style="border: 1px solid black; padding: 2px;">IP20</span> <i>general</i></div> <div><span style="border: 1px solid black; padding: 2px;">IP40</span> <i>lighting circuit</i></div> <div><span style="border: 1px solid black; padding: 2px;">IP21</span> <i>electrical sockets</i></div> </div>
COLORE STANDARD** / <i>STANDARD COLOUR**</i>	RAL 9010 Opaco	<i>Opaque RAL 9010</i>
TRATTAMENTO SUPERFICIALE A RICHIESTA <i>SURFACE TREATMENT ON REQUEST</i>	Anodizzazione, verniciatura anti-microbica, finitura decorativa	<i>Anodization, antimicrobial coating, decorative finishing</i>



## CARATTERISTICHE ELETTRICHE ELECTRICAL FEATURES

TENSIONE DI ALIMENTAZIONE / <i>FEEDING TENSION</i>	230V / 50Hz	<i>230V / 50Hz</i>
TENSIONE DI ALIMENTAZIONE AUSILIARI / <i>ADDITIONAL FEEDING TENSION</i>	12V DC	<i>12V DC</i>
POTENZA MASSIMA PRESE ELETTRICHE / <i>MAXIMUM SOCKET POWER</i>	3000W	<i>3000W</i>

\*Lunghezza riferita alla lavorazione in un unico pezzo. \*Length referred to a single-block version.

\*\*Ulteriori finiture decorative e colori RAL disponibili da pagina 76/79. \*\*For other decorative finishing and RAL colours available, see from page 76/79.

## ESEMPI DI CONFIGURAZIONE CONFIGURATION EXAMPLES

Le dotazioni impiantistiche dei seguenti modelli sono a titolo esemplificativo. I dispositivi della serie THERAPY R possono essere configurati con caratteristiche differenti in base alle esigenze impiantistiche. Per specifiche richieste vi preghiamo di contattare il nostro ufficio commerciale. *These following versions are illustrative examples. THERAPY R devices can be custom-made according to technical exigencies. For specific needs, please contact our Sales Department.*

### THERAPY R

REGOLAMENTO (UE) 2017/745  
*REGULATION (EU) 2017/745*



PESO [Kg/ml]:  
*WEIGHT [Kg/ml]:*



INSTALLAZIONE  
*INSTALLATION*



Parete - orizzontale  
*Wall - horizontal*

IDONEO PER  
*SUITABLE FOR*

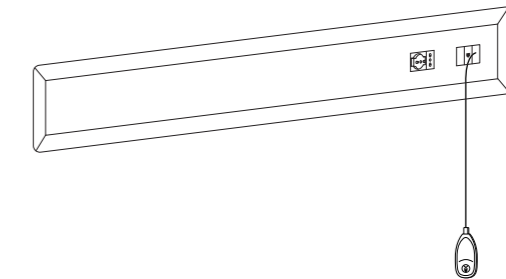
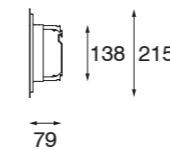

### THERAPY RG

REGOLAMENTO (UE) 2017/745  
*REGULATION (EU) 2017/745*



PESO [Kg/ml]:  
*WEIGHT [Kg/ml]:*



INSTALLAZIONE  
*INSTALLATION*



Parete - orizzontale  
*Wall - horizontal*

IDONEO PER  
*SUITABLE FOR*

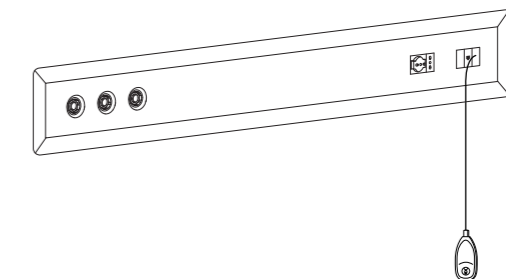
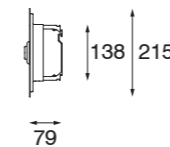

# RIANIMAZIONE E UNITÀ DI TERAPIA INTENSIVA

## INTENSIVE CARE UNIT

Le dotazioni impiantistiche dei seguenti modelli sono a titolo esemplificativo. I dispositivi della serie THERAPY R possono essere configurati con caratteristiche differenti in base alle esigenze impiantistiche. Per specifiche richieste vi preghiamo di contattare il nostro ufficio commerciale.  
*These following versions are illustrative examples. THERAPY R devices can be custom-made according to technical exigencies.  
 For specific needs, please contact our Sales Department.*

### THERAPY RG.2

REGOLAMENTO (UE) 2017/745  
 REGULATION (EU) 2017/745

PESO [Kg/ml]:  
 WEIGHT [Kg/ml]:

INSTALLAZIONE  
 INSTALLATION

IDONEO PER  
 SUITABLE FOR



Parete - orizzontale  
 Wall - horizontal

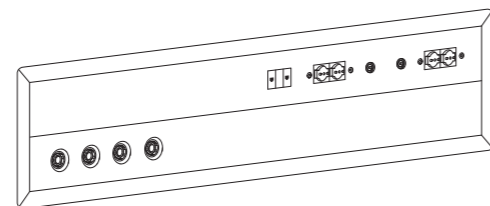
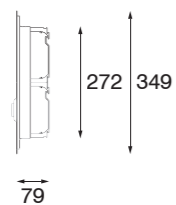

### THERAPY RG.2

REGOLAMENTO (UE) 2017/745  
 REGULATION (EU) 2017/745

PESO [Kg/ml]:  
 WEIGHT [Kg/ml]:

INSTALLAZIONE  
 INSTALLATION

IDONEO PER  
 SUITABLE FOR



Parete - orizzontale  
 Wall - horizontal

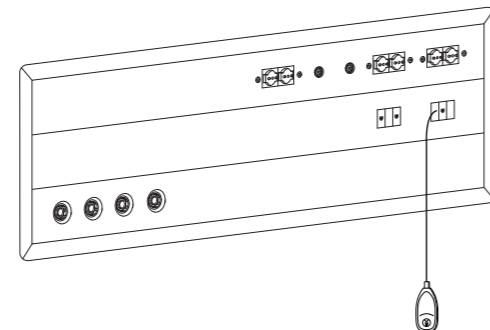
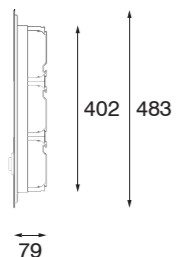

Degenza  
 Patient room



Terapia Intensiva  
 Intensive care



Laboratorio  
 Laboratory

## TRIAL

Dispositivo medicale realizzato per locali medici di gruppo 2 quali sale per anestesia, chirurgia, cure intensive, per esami angiografici ed emodinamici. TRIAL è una soluzione modulare composta da un massimo di tre profili d'alluminio al cui interno trovano spazio utenze elettriche, impianto dei gas medicali e sistema di chiamata in modo ordinato e strutturato. Nella versione con sistema di illuminazione, questa testataletto presenta due ulteriori canali per una luce confortevole e che supporta in modo efficiente l'attività dello staff medico.

*Medical device made for medical premises of group 2 such as anesthesia room, surgery room, intensive care, angiography and hemodynamic examinations rooms. TRIAL is a modular solution composed of a maximum of three aluminum profiles in which electric utilities, medical gas system and call system can find an orderly and structured location. The version with lighting system has two additional channels for a comfortable light that efficiently supports the activity of the medical staff.*

### CLASSIFICAZIONE SECONDO REGOLAMENTO (UE) 2017/745 CLASSIFICATION ACCORDING TO THE REGULATION (EU) 2017/745

- > Classe I (senza gas) - IIa/IIb (con gas)
- > Funzionamento continuo
- > Senza parti applicate
- > Installabile in locali per uso medico di gruppo 0, 1 e 2
- > Non idoneo per essere installato in ambienti con rischio esplosione (presenza di gas e vapori infiammabili)
- > Non installabile in ambienti ricchi di ossigeno con concentrazione superiore al 25% con una pressione ambientale sino a 110 kPa in condizioni normali
- > Non idoneo alle prescrizioni relative alle categorie AP e APG
- > I class (no gas) - IIa/IIb (with gas)
- > Non-stop operation
- > No sections are applied
- > Suitable for the installation in group 0, 1 and 2 medical premises
- > Not suitable for the installation in explosion risk environments (locations with gases and flammable vapours)
- > Not suitable for the installation in environments with an oxygen amount superior to the 25% with an environmental pressure until the 110kPa in usual circumstances
- > Not suitable for the categories AP and APG provisions

### DIRETTIVE E NORMATIVE DI RIFERIMENTO REFERENCE DIRECTIVES AND REGULATIONS

(EU) 2017/745  
UNI EN ISO 11197  
CEI EN 60601-1  
CEI EN 60598  
CEI EN 55015  
CEI EN 61547  
UNI CEI EN ISO 14971  
UNI CEI EN ISO 13485

# TRIAL



## CARATTERISTICHE GENERALI GENERAL FEATURES

CORPO / BODY	Estroso in alluminio	Extruded aluminium
OTTICA / DIFFUSER	Policarbonato satinato opale	Glazed opal polycarbonate diffusers
LUNGHEZZA MASSIMA* MAXIMUM LENGTH*	3700 mm	3700 mm
GRADO IP / PROTECTION DEGREE	<div style="display: flex; gap: 5px;"> <div style="border: 1px solid black; padding: 2px;">IP20</div> generale             </div> <div style="display: flex; gap: 5px;"> <div style="border: 1px solid black; padding: 2px;">IP40</div> circuito di illuminazione             </div> <div style="display: flex; gap: 5px;"> <div style="border: 1px solid black; padding: 2px;">IP21</div> prese elettriche             </div>	<div style="display: flex; gap: 5px;"> <div style="border: 1px solid black; padding: 2px;">IP20</div> general             </div> <div style="display: flex; gap: 5px;"> <div style="border: 1px solid black; padding: 2px;">IP40</div> lighting circuit             </div> <div style="display: flex; gap: 5px;"> <div style="border: 1px solid black; padding: 2px;">IP21</div> electrical sockets             </div>
COLORE STANDARD** / STANDARD COLOUR**	RAL 9010 Opaco	Opaque RAL 9010
TRATTAMENTO SUPERFICIALE A RICHIESTA SURFACE TREATMENT ON REQUEST	Anodizzazione, verniciatura anti-microbica, finitura decorativa	Anodization, antimicrobial coating, decorative finishing



## CARATTERISTICHE ILLUMINOTECNICHE LIGHTING FEATURES



Potenza Power [W]	Temp. colore Colour Temp. [K]	IRC CRI	Flusso lum. *** Lum. flux *** [lm]	Efficienza lum. Lum. effic. [lm / W]	Dimensioni/Dimensions [mm]					
					A	B	h			
↑33 ↓20	2	3000	>90	↑2739 ↓1660	186	↑83 ↓83	93	80	1200	262
↑33 ↓20	2	4000	>90	↑3267 ↓1980	186	↑99 ↓99	93	80	1200	262
↑40 ↓26	2	3000	>90	↑3320 ↓2158	186	↑83 ↓83	93	80	1200	262
↑40 ↓26	2	4000	>90	↑3960 ↓2574	186	↑99 ↓99	93	80	1200	262
↑50 ↓20	2	3000	>90	↑4150 ↓1660	186	↑83 ↓83	93	80	1450	262
↑50 ↓20	2	4000	>90	↑4950 ↓1980	186	↑99 ↓99	93	80	1450	262
↑60 ↓26	2	3000	>90	↑4980 ↓2158	186	↑83 ↓83	93	80	1450	262
↑60 ↓26	2	4000	>90	↑5940 ↓2574	186	↑99 ↓99	93	80	1450	262

\*Lunghezza riferita alla lavorazione in un unico pezzo. \*Length referred to a single-block version.  
 \*\*Ulteriori finiture decorative e colori RAL disponibili da pagina 76/79. \*\*For other decorative finishing and RAL colours available, see from page 76/79.  
 \*\*\*Il flusso effettivo potrebbe avere una tolleranza del ±10%. \*\*\*The effective flux could have a tolerance of ±10%.

## ESEMPI DI CONFIGURAZIONE CONFIGURATION EXAMPLES

Le dotazioni impiantistiche dei seguenti modelli sono a titolo esemplificativo. I dispositivi della serie TRIAL possono essere configurati con caratteristiche differenti in base alle esigenze impiantistiche. Per specifiche richieste vi preghiamo di contattare il nostro ufficio commerciale.  
 These following versions are illustrative examples. TRIAL devices can be custom-made according to technical exigencies.  
 For specific needs, please contact our Sales Department.

### TRIAL

REGOLAMENTO (UE) 2017/745  
REGULATION (EU) 2017/745

PESO [Kg/ml]:  
WEIGHT [Kg/ml]:

INSTALLAZIONE  
INSTALLATION

IDONEO PER  
SUITABLE FOR



Parete - orizzontale  
Wall - horizontal

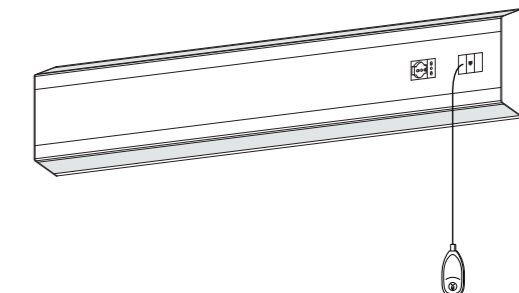
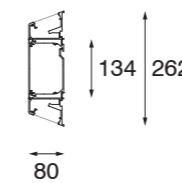

### TRIAL G

REGOLAMENTO (UE) 2017/745  
REGULATION (EU) 2017/745

PESO [Kg/ml]:  
WEIGHT [Kg/ml]:

INSTALLAZIONE  
INSTALLATION

IDONEO PER  
SUITABLE FOR



Parete - orizzontale  
Wall - horizontal

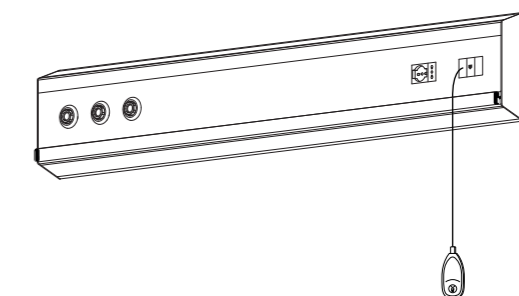
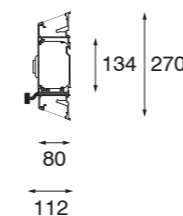
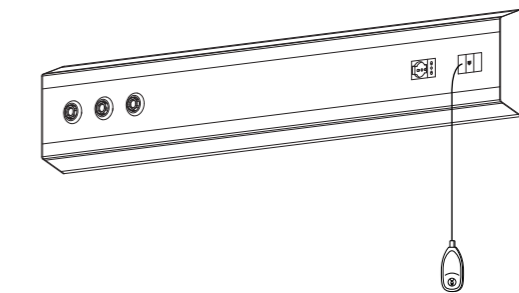
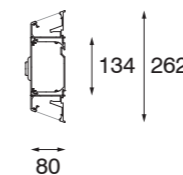

## TRIAL G

REGOLAMENTO (UE) 2017/745  
REGULATION (EU) 2017/745

PESO [Kg/ml]:  
WEIGHT [Kg/ml]:

INSTALLAZIONE  
INSTALLATION

IDONEO PER  
SUITABLE FOR

GRUPPO  
GROUP  
0 / 1

CLASSE  
CLASS  
IIa / IIb



Parete - orizzontale  
Wall - horizontal

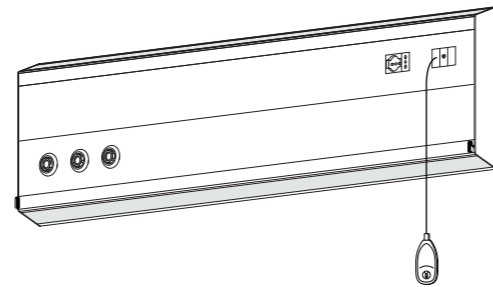
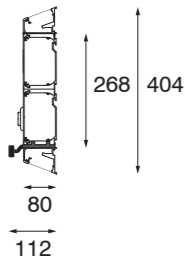
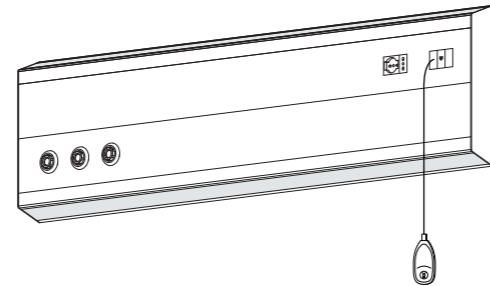
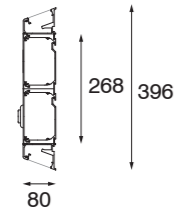

## RIANIMAZIONE E UNITÀ DI TERAPIA INTENSIVA INTENSIVE CARE UNIT

Le dotazioni impiantistiche dei seguenti modelli sono a titolo esemplificativo. I dispositivi della serie TRIAL possono essere configurati con caratteristiche differenti in base alle esigenze impiantistiche. Per specifiche richieste vi preghiamo di contattare il nostro ufficio commerciale.  
These following versions are illustrative examples. TRIAL devices can be custom-made according to technical exigencies.  
For specific needs, please contact our Sales Department.

### TRIAL G.2

REGOLAMENTO (UE) 2017/745  
REGULATION (EU) 2017/745

PESO [Kg/ml]:  
WEIGHT [Kg/ml]:

INSTALLAZIONE  
INSTALLATION

IDONEO PER  
SUITABLE FOR

GRUPPO  
GROUP  
2

CLASSE  
CLASS  
IIa / IIb



Parete - orizzontale  
Wall - horizontal

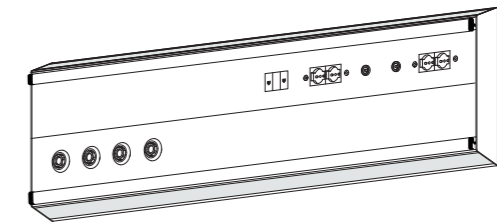
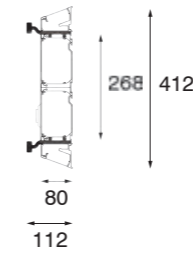

### TRIAL SG.2

REGOLAMENTO (UE) 2017/745  
REGULATION (EU) 2017/745

INSTALLAZIONE  
INSTALLATION

IDONEO PER  
SUITABLE FOR

GRUPPO  
GROUP  
2

CLASSE  
CLASS  
IIa / IIb



Parete - orizzontale  
Wall - horizontal

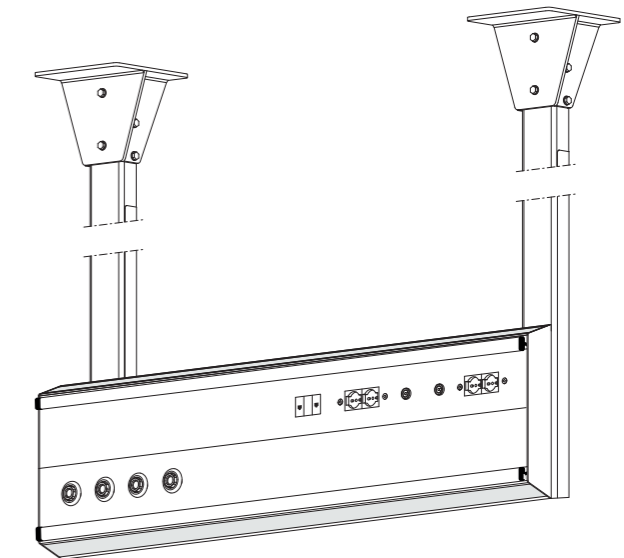
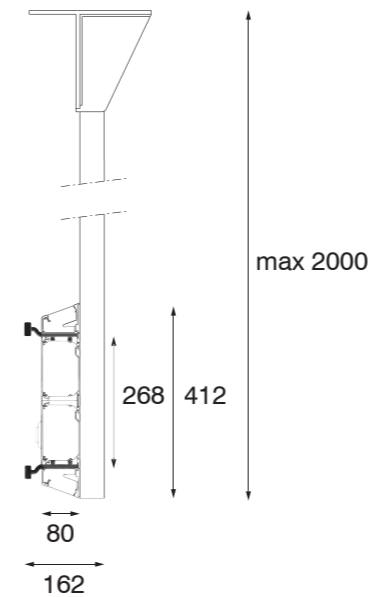

Degenza  
Patient room

Terapia Intensiva  
Intensive care

Laboratorio  
Laboratory



# TRAVI TESTALETTO PER RESIDENZE SANITARIE ASSISTITE

## *BEDHEAD UNITS FOR NURSING HOMES*



Degenza  
Patient room

● AIRWALL



62

● SAFE-WAY



66

● STAIR CARE



70

● SKYWALL



72

● WAY WALL



74

● LEVEL



76

● HORIZON



78

# AIRWALL HCL



Nelle case di riposo e in particolare in quelle destinate alla cura dell'Alzheimer, è necessario che vi sia un'illuminazione artificiale **biologicamente efficace**, idonea allo svolgimento delle attività giornaliere e volta a migliorare la qualità del ritmo sonno-veglia. Nei malati di **demenza**, i quali soffrono più facilmente di disturbi del sonno, l'applicazione del principio dell'HCL aiuta a ripristinare il più possibile un ritmo circadiano regolare.

*In nursing homes and, in particular, in facilities dedicated to treating Alzheimer's disease, it is necessary to have **biologically effective artificial lighting**, suitable for daily activities and aimed at improving the quality of the sleep-wake rhythm. In patients with **dementia**, who suffer more easily from sleep disorders, the application of the HCL principle helps to restore a regular circadian rhythm as much as possible.*

Utilizzare una luce che segue la luce del giorno, con variazione dell'intensità luminosa e della temperatura di colore, ha effetti positivi sullo stato psicologico ed emotivo dei pazienti, ma anche degli assistenti.

*Thanks to a lighting system that follows the light of day, with variations in light intensity and color temperature, the positive effects are noted on the psychological and emotional state of the patients, but also on the assistants.*

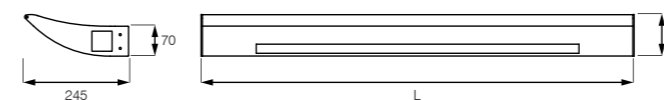

Potenza / Power	20 W	13 W
Temp. di colore / Colour Temp.	2700K+6500K	2700K
Dimensioni / Dimensions [mm]	L = 1070	
Cablaggio / Wiring	Driver Dimmerabile DALI TUNABLE Dimmable DALI TUNABLE driver	



## AIRWALL



Grazie alle sue linee semplici ed eleganti, AIRWALL si inserisce perfettamente in **case di cura, case di riposo e strutture di riabilitazione**, rendendo l'ambiente più moderno e familiare. La sua luce infatti non solo fornisce condizioni visive perfette ma favorisce lo stato di benessere del paziente, mantenendo una luminosità confortevole ed idonea allo svolgimento delle attività del personale medico.

*Thanks to its simple and elegant shape, AIRWALL fits perfectly in **nursing homes, rest house, and rehabilitation clinics** by making more modern and familiar spaces. Its light gives optimal visual conditions and patient wellness as well as a comfortable enlightening. Moreover, it allows the medical staff performing without difficulties.*

- > AIRWALL
- > AIRWALL MED
- > AIRWALL CALL
- > AIRWALL CALL MED

### CLASSIFICAZIONE SECONDO REGOLAMENTO (UE) 2017/745 CLASSIFICATION ACCORDING TO THE REGULATION (EU) 2017/745

- > Classe I
- > Funzionamento continuo
- > Senza parti applicate
- > Installabile in locali per uso medico di gruppo 0 e 1
- > Non idoneo per essere installato in ambienti con rischio esplosione (presenza di gas e vapori infiammabili)
- > Non installabile in ambienti ricchi di ossigeno con concentrazione superiore al 25% con una pressione ambientale sino a 110 kPa in condizioni normali
- > Non idoneo alle prescrizioni relative alle categorie AP e APG
- > I class
- > Non-stop operation
- > No sections are applied
- > Suitable for the installation in group 0 and 1 medical premises
- > Not suitable for the installation in explosion risk environments (locations with gases and flammable vapours)
- > Not suitable for the installation in environments with an oxygen amount superior to the 25% with an environmental pressure until the 110kPa in usual circumstances
- > Not suitable for the categories AP and APG provisions

### DIRETTIVE E NORMATIVE DI RIFERIMENTO REFERENCE DIRECTIVES AND REGULATIONS

CEI EN 60601-1  
CEI EN 60598  
CEI EN 55015  
CEI EN 61000

REGOLAMENTO (UE) 2017/745 / REGULATION (EU) 2017/745  
AIRWALL MED classe I / Class I

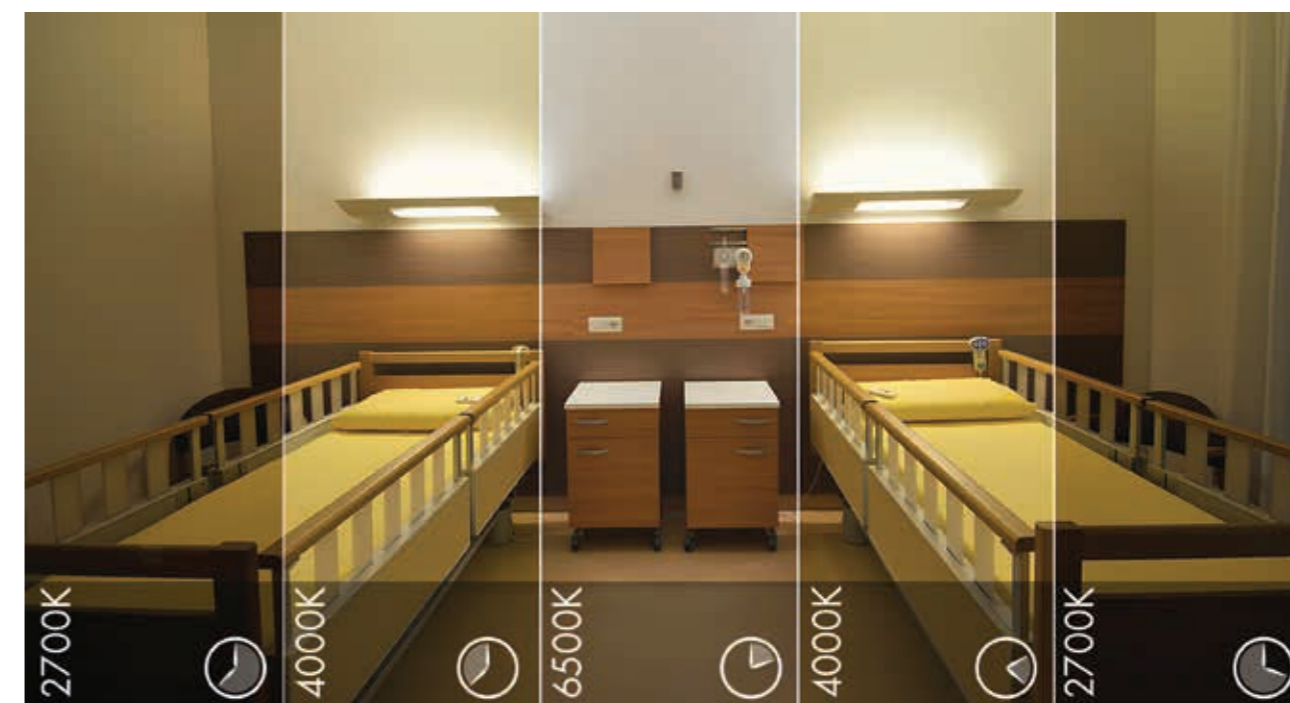

## AIRWALL

## AIRWALL MED

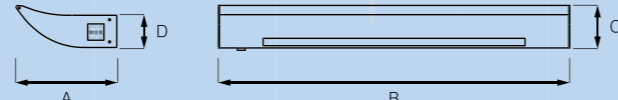

### CARATTERISTICHE GENERALI GENERAL FEATURES

CORPO / BODY	Struttura in acciaio, testate di chiusura laterali in alluminio e profilo frontale in estruso di alluminio.	<i>Steel structure, lateral aluminium end caps and aluminium front bar.</i>
OTTICA / DIFFUSER	Policarbonato satinato semitrasparente per luce indiretta. Policarbonato opale per luce diretta.	<i>Glazed opal polycarbonate diffuser for indirect lighting. Opal polycarbonate diffuser for direct lighting.</i>
GRADO IP / PROTECTION DEGREE	IP20 generale IP40 circuito di illuminazione IP21 prese elettriche	<i>general lighting circuit electrical sockets</i>
PESO / WEIGHT	7.5 Kg / m	<i>7.5 Kg / m</i>
COLORE STANDARD / STANDARD COLOUR*	Bianco Dry	<i>White Dry</i>
SU RICHIESTA / ON REQUEST	Verniciatura anti-microbica	<i>Antimicrobial coating</i>



DOTAZIONI STANDARD AIRWALL MED  
STANDARD EQUIPMENT AIRWALL MED

Presse UNEL Bipasso  
2P+T 10/16A

*UNEL Double-pass socket  
2P+E 10/16A*

### CARATTERISTICHE ILLUMINOTECNICHE LIGHTING FEATURES



Potenza Power [W]	Temp. colore Colour Temp. [K]	IRC CRI	Flusso lum.** Lum. flux** [lm]	Efficienza lum. Lum. effic. [lm / W]	Dimensioni/Dimensions [mm]						
					A	B	C	D			
124 113	2	3000	>90	12100 11040	199	188 180	100	245	770	96	70
124 113	2	4000	>90	12511 11105	199	1105 185	100	245	770	96	70
124 124	2	3000	>90	12100 11920	199	188 180	100	245	770	96	70
124 124	2	4000	>90	12511 12040	199	1105 185	100	245	770	96	70
136 113	2	3000	>90	13150 11040	199	188 180	100	245	1070	96	70
136 113	2	4000	>90	13768 11105	199	1105 185	100	245	1070	96	70
136 124	2	3000	>90	13150 11920	199	188 180	100	245	1070	96	70
136 124	2	4000	>90	13768 12040	199	1105 185	100	245	1070	96	70
148 113	2	3000	>90	14224 11040	199	188 180	100	245	1270	96	70
148 113	2	4000	>90	15023 11105	199	1105 185	100	245	1270	96	70
148 124	2	3000	>90	14224 11920	199	188 180	100	245	1270	96	70
148 124	2	4000	>90	15023 12040	199	1105 185	100	245	1270	96	70

\*Ulteriori finiture decorative e colori RAL disponibili da pagina 76/79. \*\*For other decorative finishing and RAL colours available, see from page 76/79.  
\*\*Il flusso effettivo potrebbe avere una tolleranza del ±10%. / \*\*The effective flux could have a tolerance of ±10%.

## AIRWALL CALL

## AIRWALL CALL MED

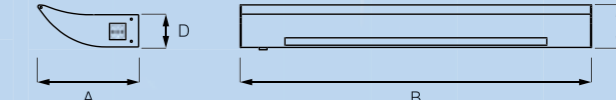
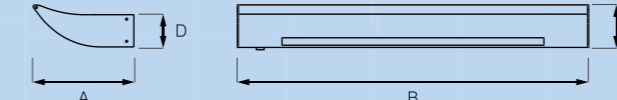
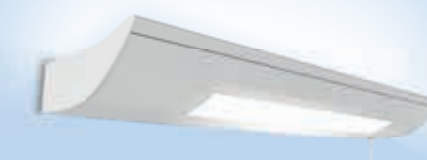

### CARATTERISTICHE GENERALI GENERAL FEATURES

CORPO / BODY	Struttura in acciaio, testate di chiusura laterali in alluminio e profilo frontale in estruso di alluminio.	<i>Steel structure, lateral aluminium end caps and aluminium front bar.</i>
OTTICA / DIFFUSER	Policarbonato satinato semitrasparente per luce indiretta. Policarbonato opale per luce diretta.	<i>Glazed opal polycarbonate diffuser for indirect lighting. Opal polycarbonate diffuser for direct lighting.</i>
GRADO IP / PROTECTION DEGREE	IP20 generale IP40 circuito di illuminazione IP21 prese elettriche	<i>general lighting circuit electrical sockets</i>
PESO / WEIGHT	8 kg / m	<i>8 kg / m</i>
COLORE STANDARD / STANDARD COLOUR*	Bianco Dry	<i>White Dry</i>
SU RICHIESTA / ON REQUEST	Verniciatura anti-microbica	<i>Antimicrobial coating</i>



DOTAZIONI STANDARD AIRWALL CALL MED  
STANDARD EQUIPMENT AIRWALL CALL MED

PULSANTIERA A 2 COMANDI  
(completa di unità di comando ad un relè per il controllo della luce); richiesta di assistenza al personale medico e di servizio e accensione della luce.

2 COMMANDS CALL SYSTEM (complete with an electronic command in a lighting control relay); request of assistance from the medical and service staff and light starting.

Presse UNEL Bipasso  
2P+T 10/16A

*UNEL Double-pass socket  
2P+E 10/16A*

### CARATTERISTICHE ILLUMINOTECNICHE LIGHTING FEATURES



Potenza Power [W]	Temp. colore Colour Temp. [K]	IRC CRI	Flusso lum.** Lum. flux** [lm]	Efficienza lum. Lum. effic. [lm / W]	Dimensioni/Dimensions [mm]						
					A	B	C	D			
124 113	2	3000	>90	12100 11700	199	188 154	100	245	880	96	70
124 113	2	4000	>90	12511 11840	199	1105 165	100	245	880	96	70
124 124	2	3000	>90	12100 11305	199	188 154	100	245	880	96	70
124 124	2	4000	>90	12511 11562	199	1105 165	100	245	880	96	70
136 113	2	3000	>90	13150 11700	199	188 154	100	245	1180	96	70
136 113	2	4000	>90	13768 11840	199	1105 165	100	245	1180	96	70
136 124	2	3000	>90	13150 11305	199	188 154	100	245	1180	96	70
136 124	2	4000	>90	13768 11562	199	1105 165	100	245	1180	96	70
148 113	2	3000	>90	14224 11700	199	188 154	100	245	1380	96	70
148 113	2	4000	>90	15023 11840	199	1105 165	100	245	1380	96	70
148 124	2	3000	>90	14224 11305	199	188 154	100	245	1380	96	70
148 124	2	4000	>90	15023 11562	199	1105 165	100	245	1380	96	70

\*Ulteriori finiture decorative e colori RAL disponibili da pagina 76/79. \*\*For other decorative finishing and RAL colours available, see from page 76/79.  
\*\*Il flusso effettivo potrebbe avere una tolleranza del ±10%. / \*\*The effective flux could have a tolerance of ±10%.



# SAFE-WAY

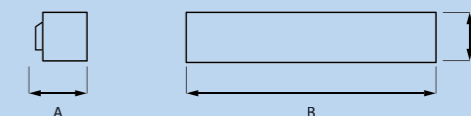

# SAFE-WAY



SAFE-WAY è una applique di illuminazione ideale per case di riposo che risulta discreta all'interno della stanza di degenza. Sebbene sia semplice e minimale, assicura un'illuminazione di qualità e confortevole per pazienti e personale medico.

Grazie alla luce HCL (Human Centric Lighting) questa applique contribuisce a rendere l'ambiente di vita più equilibrato e sereno favorendo il benessere del paziente e il naturale bioritmo circadiano.

*SAFE-WAY is an ideal lighting applique for nursing homes that is discreet inside the patient's room. Despite being simple and minimal, it guarantees quality and comfortable lighting for patients and medical staff.*

*Thanks to the HCL (Human Centric Lighting) light, this wall light contributes to making the living environment more balanced and serene, promoting the patient's well-being and the natural circadian rhythm.*

**DIRETTIVE E NORMATIVE DI RIFERIMENTO**  
**REFERENCE DIRECTIVES AND REGULATIONS**  
 CEI EN 60601-1  
 CEI EN 60598  
 CEI EN 55015  
 CEI EN 61000



## CARATTERISTICHE GENERALI

### GENERAL FEATURES



CORPO / <i>BODY</i>	Corpo in acciaio	<i>Steel body</i>
OTTICA / <i>DIFFUSER</i>	Polycarbonato opale satinato per luce diretta Metacrilato opale per luce indiretta	<i>Opal polycarbonate diffuser for direct light</i> <i>Opal methacrylate diffuser for indirect light</i>
GRADO IP / <i>PROTECTION DEGREE</i>	IP40	IP40
PESO / <i>WEIGHT</i>	6.7 Kg / m	6.7 Kg / m
COLORE STANDARD* / <i>STANDARD COLOUR*</i>	Bianco Dry	<i>Dry White</i>
TRATTAMENTO SUPERFICIALE A RICHIESTA <i>SURFACE TREATMENT ON REQUEST</i>	Verniciatura anti-microbica	<i>Antimicrobial coating</i>

## CARATTERISTICHE ILLUMINOTECNICHE

### LIGHTING FEATURES



Potenza Power [W]	Temp. colore Colour Temp. [K]	IRC CRI	Flusso lum. ** Lum. flux ** [lm]	Efficienza lum. Lum. effic. [lm / W]	Dimensioni/Dimensions [mm]		
					A	B	C
↑17 ↓17	2700	>90	↑1764 ↓1176	↑104 ↓69	60,25	841	95
	6500	>90	↑1878 ↓1252	↑110 ↓74	60,25	841	95
↑23 ↓23	2700	>90	↑2504 ↓1670	↑109 ↓73	60,25	1121	95
	6500	>90	↑2818 ↓1879	↑123 ↓82	60,25	1121	95
↑29 ↓29	2700	>90	↑3221 ↓2147	↑111 ↓74	60,25	1401	95
	6500	>90	↑3428 ↓2285	↑118 ↓79	60,25	1401	95
↑36 ↓36	2700	>90	↑3231 ↓2154	↑90 ↓60	60,25	1681	95
	6500	>90	↑3475 ↓2317	↑97 ↓64	60,25	1681	95

\*Ulteriori finiture decorative e colori RAL disponibili da pagina 76/79. \*\*For other decorative finishing and RAL colours available, see from page 76/79.  
 \*\*Il flusso effettivo potrebbe avere una tolleranza del ±10%. / \*\*The effective flux could have a tolerance of ±10%.

# SAFE-WAY

## DISPOSITIVO DI SANIFICAZIONE SANIFICATION DEVICE



La lampada SAFE-WAY può essere anche un dispositivo di sanificazione attraverso l'integrazione al suo interno di un generatore di ioni bipolari al plasma freddo, una tecnologia che permette di riprodurre gli stessi ioni positivi e negativi presenti in natura, garantendo in questo modo un'azione sanificante continua.

La generazione di ioni positivi e negativi innesca reazioni chimiche naturali distruggendo la struttura proteica di virus e batteri, rendendoli di fatto innocui e ossidando i composti organici volatili nell'aria (VOC). In questo modo si tiene sotto controllo sia la crescita dei virus, microbi e batteri nell'area specifica sia il contenuto di VOC nell'aria.

SAFE-WAY can also be a sanitization device through the integration within it of a cold plasma bipolar ion generator, a technology that allows the reproduction of the same positive and negative ions present in nature, thus guaranteeing a constant sanitizing action.

The generation of positive and negative ions triggers natural chemical reactions, destroying the protein structure of viruses and bacteria, effectively rendering them harmless and oxidizing volatile organic compounds present in the air (VOCs). In this way, both the growth of viruses, microbes and bacteria in the affected area and the VOC content in the air are kept under control.

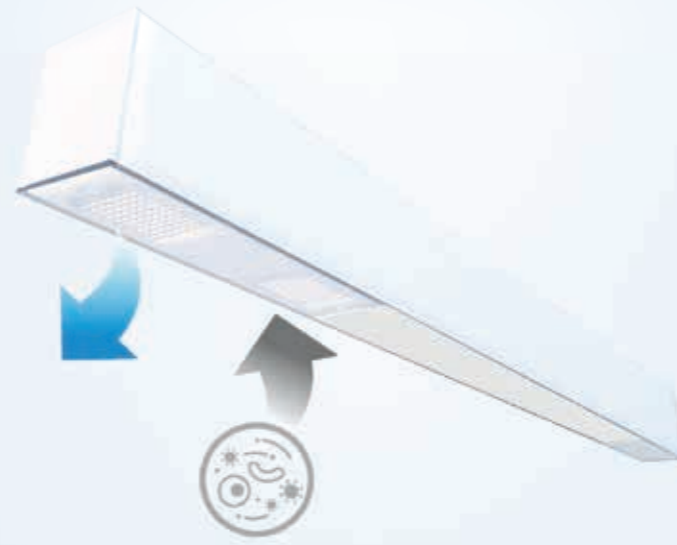

## CARATTERISTICHE ILLUMINOTECNICHE LIGHTING FEATURES



Potenza Power [W]	Temp. colore Colour Temp. [K]	IRC CRI	Flusso lum. ** Lum. flux ** [lm]	Efficienza lum. Lum. effic. [lm / W]	Dimensioni/Dimensions [mm]		
					A	B	C
↑13 ↓13	2700	>90	↑1158 ↓772	↑89 ↓59	50	941	95
	6500	>90	↑1245 ↓830	↑96 ↓64	50	941	95
↑17 ↓17	2700	>90	↑1764 ↓1176	↑104 ↓69	50	1221	95
	6500	>90	↑1878 ↓1252	↑110 ↓74	50	1221	95
↑23 ↓23	2700	>90	↑2504 ↓1670	↑109 ↓73	50	1501	95
	6500	>90	↑2818 ↓1879	↑123 ↓82	50	1501	95
↑29 ↓29	2700	>90	↑3221 ↓2147	↑111 ↓74	50	1781	95
	6500	>90	↑3428 ↓2285	↑118 ↓79	50	1781	95

\*Ulteriori finiture decorative e colori RAL disponibili da pagina 76/79. \*\*For other decorative finishing and RAL colours available, see from page 76/79.  
\*\*Il flusso effettivo potrebbe avere una tolleranza del ±10%. / \*\*The effective flux could have a tolerance of ±10%.

## PERSONALIZZAZIONE ACUSTICA ACOUSTIC CUSTOMIZATION

La lampada SAFE-WAY è personalizzabile attraverso l'applicazione di un pannello frontale, realizzato con tessuto fonoassorbente. Questo pannello, disponibile in finiture con colori diversi, rende la lampada maggiormente adattabile all'arredo e conferisce maggior comfort acustico all'ambiente.

Per migliorare ulteriormente le prestazioni acustiche negli ambienti chiusi, questa soluzione può essere implementata utilizzando un rivestimento a parete, in alternativa alla classica boiserie di legno, costituito da un pannello fonoassorbente dello spessore di 3 cm.

Dimensioni, materiali e forme si possono plasmare a seconda delle esigenze specifiche per un risultato che diventa un complemento di arredo che unisce comfort acustico e luminoso.

The SAFE-WAY lamp can be customized through the application of a front panel, made with sound-absorbing fabric. This panel, available in different coloured finishes, makes the lamp more adaptable to furnishings and gives greater acoustic comfort to the environment.

To further improve the acoustic performance in closed environments, this solution can be implemented using a wall cladding, as an alternative to the classic wooden boiserie, made up of a 3 cm thick sound-absorbing panel.

Dimensions, materials, and shapes can be realized according to specific needs for a result that becomes a furnishing accessory that combines acoustic and luminous comfort.



# STAIR CARE

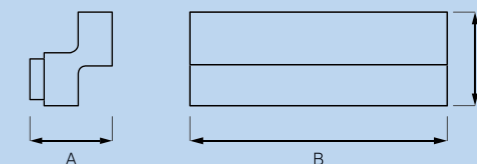

## CARATTERISTICHE GENERALI GENERAL FEATURES



CORPO / BODY	Estruso in alluminio	<i>Extruded aluminium</i>
OTTICA / DIFFUSER	Diffusori in policarbonato opale satinato	<i>Glazed opal polycarbonate diffusers</i>
GRADO IP / PROTECTION DEGREE	IP40	IP40
PESO / WEIGHT	5 Kg / m	<i>5 Kg / m</i>
COLORE STANDARD / STANDARD COLOUR*	RAL 9003 Opaco	<i>Opaque RAL 9003</i>
TRATTAMENTO SUPERFICIALE A RICHIESTA SURFACE TREATMENT ON REQUEST	Verniciatura anti-microbica	<i>Antimicrobial coating</i>

# STAIR CARE



Lampada testaleto a luce diretta e indiretta, dal design semplice e lineare che si armonizza agli stili e alle necessità delle case di cura e case di riposo. STAIR CARE si compone di due profili d'alluminio dove al loro interno sono alloggiati sorgenti luminose LED per la luce ambiente, luce lettura e a richiesta luce notturna.

Con una **finitura personalizzata nel colore**, STAIR CARE non è solamente una testaleto ma diventa protagonista all'interno della stanza.

*Direct and indirect light emission bedhead unit with a simple and linear design that harmonizes with the styles and needs of nursing homes and rest homes. STAIR CARE is composed of two aluminum profiles designed for housing LED light sources for ambient light, reading light and, on request, night light.*

*STAIR CARE can have a **custom finish in color**, this lamp is not just a bedhead unit but it can become the protagonist inside the room.*

**DIRETTIVE E NORMATIVE DI RIFERIMENTO**  
**REFERENCE DIRECTIVES AND REGULATIONS**  
CEI EN 60601-1  
CEI EN 60598  
CEI EN 55015  
CEI EN 61000

## CARATTERISTICHE ILLUMINOTECNICHE LIGHTING FEATURES



Potenza Power [W]	Temp. colore Colour Temp. [K]	IRC CRI	Flusso lum. ** Lum. flux ** [lm]		Efficienza lum. Lum. effic. [lm / W]	Dimensioni/Dimensions [mm]				
						A	B	C		
↑13 ↓13	2	3000	>90	↑1246 ↓1246	220	↑96 ↓96	110	120	600	138
↑13 ↓13	2	4000	>90	↑1491 ↓1491	220	↑115 ↓115	110	120	600	138
↑20 ↓20	2	3000	>90	↑1920 ↓1920	220	↑96 ↓96	110	120	900	138
↑20 ↓20	2	4000	>90	↑2300 ↓2300	220	↑115 ↓115	110	120	900	138
↑26 ↓26	2	3000	>90	↑2492 ↓2492	220	↑96 ↓96	110	120	1200	138
↑26 ↓26	2	4000	>90	↑2982 ↓2981	220	↑115 ↓115	110	120	1200	138

\*Ulteriori finiture decorative e colori RAL disponibili da pagina 76/79. \*\*For other decorative finishing and RAL colours available, see from page 76/79.  
\*\*Il flusso effettivo potrebbe avere una tolleranza del ±10%. / \*\*The effective flux could have a tolerance of ±10%.



# SKYWALL



## CARATTERISTICHE GENERALI GENERAL FEATURES



CORPO / BODY	Estruso in alluminio Testate laterali in ABS	<i>Extruded aluminium ABS end caps</i>
OTTICA / DIFFUSER	Diffusori in policarbonato opale satinato	<i>Glazed opal polycarbonate diffusers</i>
GRADO IP / PROTECTION DEGREE	IP40	IP40
PESO / WEIGHT	6 Kg / m	<i>6 Kg / m</i>
COLORE STANDARD / STANDARD COLOUR*	RAL 9003 Opaco	<i>Opaque RAL 9003</i>
TRATTAMENTO SUPERFICIALE A RICHIESTA SURFACE TREATMENT ON REQUEST	Verniciatura anti-microbica	<i>Antimicrobial coating</i>

# SKYWALL



Applique a luce diretta e indiretta caratterizzata da un corpo sottile e minimale.  
La luce diretta opportunamente direzionata (wallwasher) assicura un'illuminazione ideale per il personale sanitario e allo stesso tempo un ottimale comfort visivo per il paziente.  
**SKYWALL** rappresenta il giusto equilibrio tra design e tecnica per ambienti dove la discrezione è di assoluta importanza.

**DIRETTIVE E NORMATIVE DI RIFERIMENTO**  
**REFERENCE DIRECTIVES AND REGULATIONS**  
CEI EN 60601-1  
CEI EN 60598  
CEI EN 55015  
CEI EN 61000

*Direct and indirect light wall fixture characterized by a thin and minimal body.  
Its direct light, appropriately directed (wallwasher), ensures ideal lighting for healthcare personnel and at the same time optimal visual comfort patient. SKYWALL represents the right balance between design and technique for environments where discretion is of absolute importance.*

## CARATTERISTICHE ILLUMINOTECNICHE LIGHTING FEATURES



Potenza Power [W]	Temp. colore Colour Temp. [K]	IRC CRI	Flusso lum. ** Lum. flux ** [lm]		Efficienza lum. Lum. eff. [lm / W]	Dimensioni/Dimensions [mm]			
						A	B	C	
↑24 ↓24	2	3000	↑2317 ↓1893	220	↑97 ↓79	110	130	600	35
↑24 ↓24	2	4000	↑2784 ↓2265	220	↑116 ↓94	110	130	600	35
↑36 ↓36	2	3000	↑3475 ↓2839	220	↑97 ↓79	110	130	900	35
↑36 ↓36	2	4000	↑4160 ↓3398	220	↑116 ↓94	110	130	900	35
↑48 ↓48	2	3000	↑4635 ↓3786	220	↑97 ↓79	110	130	1200	35
↑48 ↓48	2	4000	↑5546 ↓4530	220	↑116 ↓94	110	130	1200	35

\*Ulteriori finiture decorative e colori RAL disponibili da pagina 76/79. \*\*For other decorative finishing and RAL colours available, see from page 76/79.  
\*\*Il flusso effettivo potrebbe avere una tolleranza del ±10%. / \*\*The effective flux could have a tolerance of ±10%.



# WAY WALL

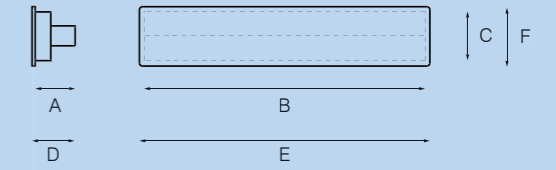

## CARATTERISTICHE GENERALI

### GENERAL FEATURES

CORPO / BODY	Estruso in alluminio	Extruded aluminium
OTTICA / DIFFUSER	Diffusori in policarbonato opale satinato traslucido	Glazed opal polycarbonate diffusers
GRADO IP / PROTECTION DEGREE	IP40	IP40
PESO / WEIGHT	9 Kg / m	9 Kg / m
COLORE STANDARD* / STANDARD COLOUR*	Bianco Dry	White Dry
TRATTAMENTO SUPERFICIALE A RICHIESTA / SURFACE TREATMENT ON REQUEST	Verniciatura anti-microbica	Antimicrobial coating



# WAY WALL



Applique a luce diretta e indiretta, realizzata da un doppio profilo estruso d'alluminio, dalle dimensioni ridotte. Studiata per le stanze di degenza di case di riposo e case di cura, può dare carattere anche agli ambienti comuni dedicati ai momenti di svago e relax. Per la sala di degenza, grazie al **pannello accessorio in legno MDF**, WAY WALL diventa oltre che una lampada testataleto anche un elemento d'arredo decorativo che si armonizza facilmente all'ambiente. Le sue linee decise e semplici rendono questa applique una soluzione efficiente e flessibile.

*Wall lamp with direct and indirect light, made of a double extruded aluminum profile, with reduced dimensions. Designed for nursing homes and rest homes patient rooms, it can also give character to the common areas dedicated to leisure and relaxation moments. For the patient room, thanks to the **MDF wooden accessory panel**, WAY WALL becomes not only a bedside unit but also a decorative furnishing element that harmonizes easily with the environment.*



**DIRETTIVE E NORMATIVE DI RIFERIMENTO**  
**REFERENCE DIRECTIVES AND REGULATIONS**  
 CEI EN 60601-1  
 CEI EN 60598  
 CEI EN 55015  
 CEI EN 61000

## CARATTERISTICHE ILLUMINOTECNICHE

### LIGHTING FEATURES



Potenza Power [W]	Temp. colore Colour Temp. [K]	IRC CRI	Flusso lum. Lum. flux** [lm]	Efficienza lum. Lum. effic. [lm / W]	Dimensioni/Dimensions [mm]								
					A	B	C	E	F	G			
113 ↓13	2	3000	>90	1248 ↓1248	220	196 ↓96	110	128	600	156	138	630	190
113 ↓13	2	4000	>90	1491 ↓1491	220	115 ↓115	110	128	600	156	138	630	190
120 ↓20	2	3000	>90	1920 ↓1917	220	196 ↓96	110	128	900	156	138	930	190
120 ↓20	2	4000	>90	2294 ↓2294	220	115 ↓115	110	128	900	156	138	930	190
126 ↓26	2	3000	>90	2496 ↓2492	220	196 ↓96	110	128	1200	156	138	1230	190
126 ↓26	2	4000	>90	2982 ↓2982	220	115 ↓115	110	128	1200	156	138	1230	190
138 ↓38	2	3000	>90	3648 ↓3642	220	196 ↓96	110	128	1800	156	138	1830	190
138 ↓38	2	4000	>90	4358 ↓4358	220	115 ↓115	110	128	1800	156	138	1830	190

\*Ulteriori finiture decorative e colori RAL disponibili da pagina 76/79. \*\*For other decorative finishing and RAL colours available, see from page 76/79.  
 \*\*Il flusso effettivo potrebbe avere una tolleranza del ±10%. / \*\*The effective flux could have a tolerance of ±10%.





# LEVEL



# LEVEL



LEVEL è una lampada testaletto dalla linea fine ed elegante, ideale per l'installazione in **case di riposo** dove non vengono richieste particolari funzioni. La sua forma consente una perfetta distribuzione della **luce diretta** ottenuta grazie alle sorgenti LED, evitando l'abbagliamento del paziente e senza disturbare gli altri degenti all'interno della stanza.

LEVEL è un prodotto sicuro e che consente di illuminare le stanze con semplicità ed efficienza, garantendo un'illuminazione ottimale.

*LEVEL is a fine and elegant bedhead unit suitable for the installation in **rest houses** where no particular functions are requested. Its shape gives a perfect **direct lighting distribution**, obtained using the LED sources, avoiding the patient's glare and without disturbing other patients inside the room.*

*LEVEL is a safety and modern device suitable to illuminate rooms with simplicity and efficiency, giving an optimal lighting level inside the room.*

**DIRETTIVE E NORMATIVE DI RIFERIMENTO**  
**REFERENCE DIRECTIVES AND REGULATIONS**  
 CEI EN 60601-1  
 CEI EN 60598  
 CEI EN 55015  
 CEI EN 61000

## CARATTERISTICHE GENERALI

### GENERAL FEATURES



CORPO / <i>BODY</i>	Estruso in alluminio	<i>Extruded aluminium</i>
OTTICA / <i>DIFFUSER</i>	Diffusore in policarbonato semitrasparente wallwasher	<i>Semitransparent wallwasher polycarbonate diffuser</i>
GRADO IP / <i>PROTECTION DEGREE</i>	IP40	IP40
PESO / <i>WEIGHT</i>	2.1 Kg / m	<i>2.1 Kg / m</i>
COLORE STANDARD / <i>STANDARD COLOUR*</i>	RAL 9003 Opaco	<i>Opaque RAL 9003</i>
TRATTAMENTO SUPERFICIALE A RICHIESTA / <i>SURFACE TREATMENT ON REQUEST</i>	Verniciatura anti-microbica	<i>Antimicrobial coating</i>

## CARATTERISTICHE ILLUMINOTECNICHE

### LIGHTING FEATURES



Potenza Power [W]	Temp. colore Colour Temp. [K]	IRC CRI	Flusso lum. ** Lum. flux ** [lm]	Efficienza lum. Lum. effic. [lm / W]	Dimensioni/Dimensions [mm]		
					A	B	C
26	3000	>90	1950	75	102	570	55
26	4000	>90	2310	90	102	570	55
36	3000	>90	2693	75	102	850	55
36	4000	>90	3222	90	102	850	55
48	3000	>90	3591	75	102	1130	55
48	4000	>90	4297	90	102	1130	55

\*Ulteriori finiture decorative e colori RAL disponibili da pagina 76/79. \*\*For other decorative finishing and RAL colours available, see from page 76/79.  
 \*\*Il flusso effettivo potrebbe avere una tolleranza del ±10%. / \*\*The effective flux could have a tolerance of ±10%.



# HORIZON

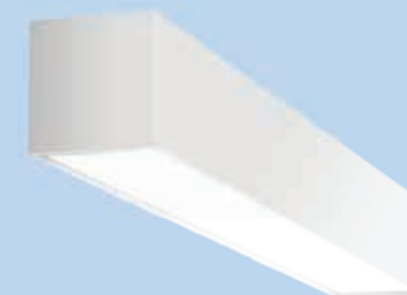

## CARATTERISTICHE GENERALI GENERAL FEATURES

CORPO / BODY	Corpo in acciaio	Steel body
OTTICA / DIFFUSER	Policarbonato opale satinato per luce diretta Metacrilato opale per luce indiretta	Opal polycarbonate diffuser for direct light Opal methacrylate diffuser for indirect light
GRADO IP / PROTECTION DEGREE	IP40	IP40
PESO / WEIGHT	6.7 Kg / m	6.7 Kg / m
COLORE STANDARD* / STANDARD COLOUR*	Bianco Dry	Dry White
TRATTAMENTO SUPERFICIALE A RICHIESTA SURFACE TREATMENT ON REQUEST	Verniciatura anti-microbica	Antimicrobial coating



# HORIZON



Una semplice applique a parete a luce diretta e indiretta dalle forme lineari e squadrate. Destinata alle sale di degenza delle case di riposo e case di cura, trova facilmente applicazione anche nei locali di ritrovo e aggregazione, come ad esempio sale da pranzo e sale ricreative. HORIZON dona una luce morbida e confortevole che rende l'ambiente familiare e rilassante.

*A simple wall lamp, with direct and indirect light emission, with linear and square shapes. Studied for nursing homes and rest homes patient room, it can also be applied in meeting and leisure areas, such as dining rooms and relaxing rooms. HORIZON gives a soft and comfortable light that makes the environment familiar and relaxing.*

**DIRETTIVE E NORMATIVE DI RIFERIMENTO**  
**REFERENCE DIRECTIVES AND REGULATIONS**  
CEI EN 60601-1  
CEI EN 60598  
CEI EN 55015  
CEI EN 61000

## CARATTERISTICHE ILLUMINOTECNICHE LIGHTING FEATURES



Potenza Power [W]	Temp. colore Colour Temp. [K]	IRC CRI	Flusso lum. ** Lum. flux ** [lm]		Efficienza lum. Lum. effic. [lm / W]	Dimensioni/Dimensions [mm]			
						A	B	C	
↑13 ↓13	2	3000	↑1369 ↓965	242	↑105 ↓74	121	120	600	138
↑13 ↓13	2	4000	↑1638 ↓1155	242	↑126 ↓89	121	120	600	138
↑20 ↓20	2	3000	↑2100 ↓1480	242	↑105 ↓74	121	120	900	138
↑20 ↓20	2	4000	↑2520 ↓1780	242	↑126 ↓89	121	120	900	138
↑26 ↓26	2	3000	↑2737 ↓1930	242	↑105 ↓74	121	120	1200	138
↑26 ↓26	2	4000	↑3276 ↓2310	242	↑126 ↓89	121	120	1200	138

\*Ulteriori finiture decorative e colori RAL disponibili da pagina 76/79. \*\*For other decorative finishing and RAL colours available, see from page 76/79.  
\*\*Il flusso effettivo potrebbe avere una tolleranza del ±10%. / \*\*The effective flux could have a tolerance of ±10%.

# PERSONALIZZAZIONE E ACCESSORI

## *CUSTOM AND ACCESSORIES*

● PERSONALIZZAZIONE  
*CUSTOM*

82

● FINITURE  
*FINISHINGS*

84

● SISTEMA DI CHIAMATA  
*NURSE CALLING SYSTEM*

85

● ACCESSORI  
*ACCESSORIES*

86

● SISTEMA PENSILE  
*SUSPENSION SYSTEM*

87

# PERSONALIZZAZIONE / CUSTOM

## TRATTAMENTI SUPERFICIALI / SURFACE TREATMENTS

### VERNICIATURA O ANODIZZAZIONE PAINTING OR ANODIZING

Le travi testaleto ATENA LUX possono essere anodizzate oppure verniciate. Innanzitutto vengono spazzolate meccanicamente e anodizzate in tinta naturale: si parla di **anodizzazione** riferendosi alla fase in cui l'alluminio passa dallo stato di metallo a quello di superficie vera e propria, modificando fisicamente la struttura molecolare e rendendo la superficie esterna più robusta. In alternativa possono essere **verniciate** a polveri poliestere, stabilizzate ai raggi UV e termoindurenti a 180°C, previo trattamento di sgrassamento, fosfatazione e lavaggio.

*ATENA LUX bedhead units can be anodized or painted. First of all, they are brushed and anodized in natural color: we talk about **anodizing** with reference to the process in which aluminium passes from its state of metal to the one of concrete surface by modifying the molecular structure, making its external surface definitely stronger.*

*Alternatively, bedhead units can be **painted** with polyester powders, UV rays stabilized and thermosetting at 180°C, with degreasing, phosphating and washing treatment.*



Anodizzato  
alluminio naturale / natural aluminium

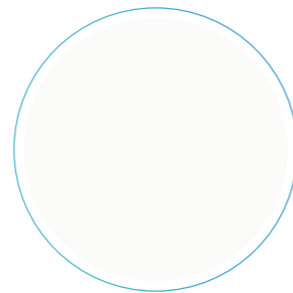

RAL 9010  
bianco opaco / mat white

### VERNICIATURA ANTI-MICROBICA ANTI-MICROBIAL PAINTING

Su richiesta è possibile verniciare gli apparecchi con delle speciali **vernici anti-microbiche**, attraverso l'applicazione di una vernice in polvere che possiede caratteristiche anti-microbiche e protegge costantemente le superfici da batteri, virus, muffe, alghe.

A differenza delle normali vernici antibatteriche, questo tipo di verniciatura mantiene inalterata la propria funzione negli anni. Agisce grazie a **ioni di metalli** presenti nel film di vernice in polvere i quali, in presenza di umidità residua nell'ambiente, vengono attivati verso la superficie del prodotto interessato. Quando l'organismo microbico si deposita sulla superficie viene distrutto dall'azione costante di questi ioni a lunga durata, consentendo la protezione e la profilassi contro i parassiti.

*On request, it is possible to paint the devices with special paints with **anti-microbial effects**. This constantly protects the surfaces from bacteria, viruses, fungi and algae.*

*Differently from the common anti-bacterial paintings, this painting maintains its function unaltered across the years. It acts thanks to **metal ions** that are present in the powder paint film becoming active on the surface of the interested product, when a residual environmental humidity occurs. When the microbial organism comes to the surface, it is destroyed by the constant action of these long lasting ions, allowing the protection and the prophylaxis against parasites.*



### GAMMA COLORI

La tabella che segue riporta una lista di colori disponibili suggeriti. Tutti i colori hanno una finitura opaca, a richiesta può essere lucida. Per altre colorazioni vi preghiamo di contattare l'ufficio commerciale.

### COLOUR RANGE

*The following table shows a list of suggested available colors. All colours have a standard opaque finish, on request it can be glossy. For other colours, please contact the sales office.*

#### STANDARD



RAL 9010  
BIANCO  
WHITE



RAL 9003  
BIANCO PURO  
PURE WHITE



BIANCO DRY  
(RAL 9003 con finitura raggrinzante)  
DRY WHITE  
(RAL 9003 wrinkle finish)

#### METAL



COPPER  
SHINE



JOY  
GOLD



TITAN  
LUX



DEEP  
BLUE

#### RAL



RAL 5015  
BLU  
BLUE



RAL 5014  
GRIGIO BLU  
GREY BLUE



RAL 6024  
VERDE  
GREEN



RAL 6027  
VERDE  
GREEN



RAL 4005  
VIOLA  
VIOLET



RAL 4010  
TELEMAGENTA



RAL 2000  
ARANCIO  
ORANGE



RAL 1003  
GIALLO  
YELLOW



RAL 7040  
GRIGIO  
GREY



RAL 9006  
GRIGIO  
GREY

## FINITURE FINISHINGS

### FINITURE DEL LEGNO MDF

I prodotti personalizzabili con il pannello in legno MDF sono ARMONIA, SANIMED e WAY WALL.

Per questi prodotti è possibile richiedere una finitura in linea con le scelte estetiche e architettoniche degli ambienti. Di seguito vi proponiamo una scelta di soluzioni standard, per esigenze specifiche è possibile richiedere altre tipologie di finiture.

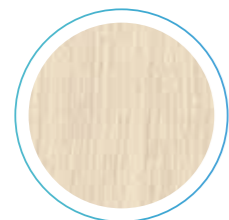

Rovere  
Durmast

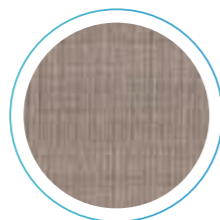

Promenade  
Promenade

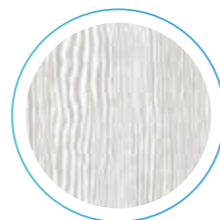

Larice  
Larch

### MDF WOOD FINISHINGS

Our products ARMONIA, SANIMED and WAY WALL can be customized with the MDF wood panel.

For these products it is possible to request a finish in line with the aesthetic and architectural taste of the rooms. Below we propose a choice of standard solutions, for specific needs other finishes are available on request.

### FINITURE DECORATIVE SPECIALI

Particolari texture e immagini possono essere applicate alle travi testaleto grazie a diverse tecniche di decorazione.

Per alcuni modelli di testaleto ATENA LUX utilizza la **sublimazione**: una lavorazione che consiste nel trasferimento di appositi inchiostri colorati dalla pellicola sublimata alla superficie verniciata, impressi sotto l'azione di temperatura e pressione adeguata. Le sublimazioni vengono eseguite con **sostanze ecologiche** esenti da composti Organici Volatili (COV/VOC), garantendo una personalizzazione grafica dei prodotti particolarmente **sicura e innocua**.

Per altri modelli attraverso il processo di "dippatura" o "**water transfer printing**", è possibile realizzare decorazioni tridimensionali per immersione che vengono rifinite con una verniciatura trasparente dalla finitura lucida o opaca di protezione. Anche questa tecnica decorativa ha un **impatto ambientale minimo**: i processi di lavorazione infatti non producono residui chimici da smaltire e l'acqua contenuta nella vasca per l'immersione può essere riutilizzata per diverse sessioni di dippatura.

### SPECIAL DECORATIVE FINISHINGS

Thanks to different decoration techniques particular textures and images can be applied to the bedhead units.

For some models ATENA LUX uses the **sublimation technique**: this process consists on transferring special colored inks from the sublimating film to the painting surface, impressing them under the action of an adequate temperature and pressure. The sublimation is realized with **eco-friendly substances** without Volatile Organic Compounds (VOC/VOC) as a guarantee for a **safe and harmless graphic personalization**.

For other models, through the process of "dipping" or "**water transfer printing**", it is possible to create three-dimensional decorations by immersion. As final treatment, a transparent painting is applied, with a glossy or matte finish, to protect the bedhead unit. Also this decorative technique has a **minimal environmental impact**: the manufacturing processes do not produce chemical residues subject to disposal and the water contained in the immersion tank can be reused for different dipping sessions.

## SISTEMA DI CHIAMATA NURSE CALLING SYSTEM



Atena Lux propone la fornitura della pulsantiera per il sistema di chiamata integrato al testaleto.

Le dotazioni accessorie delle travi testaleto Atena Lux vengono definite in fase di progettazione e possono variare in relazione alle varie esigenze. Moduli con pulsanti e prese di chiamata con relative pulsantiere pensili vengono forniti a seconda dell'impianto di chiamata prescelto.

Nella pulsantiera proposta sono disponibili **da uno a tre comandi** che permettono la richiesta di assistenza al personale medico e di servizio (un comando), aggiungendo l'accensione o lo spegnimento autonomo delle luci ambiente e lettura (da due a tre comandi). Nei modelli a più comandi, per quanto riguarda la gestione delle luci, è prevista un'unità di comando elettronico installata in un relè di controllo della luce.

> La pulsantiera è dotata di un cavo lungo 2 metri e gancio a spirale a 7 poli, così da facilitarne la **disconnessione rapida**. Questo impedisce inoltre, in caso di strappo accidentale, la rottura del connettore della presa DIN a 6 poli collocata direttamente sull'unità testaleto.

> La presa DIN si integra al corpo illuminante **senza l'ausilio di placche esterne**, mantenendo intatta l'eleganza del prodotto e consentendo una maggiore uniformità degli elementi.

> Il **design ergonomico** e l'**impugnatura semplificata** facilitano la pulizia e la manutenzione del sistema di chiamata.

Atena Lux supplies the bedhead units complete with a call system keypad integrated.

The optional accessories of Atena Lux bedhead units are defined during design stage and they can be modified according to the circumstances. Modules with buttons and call system keypad can be furnished according to the specific call system required by the customer.

The suggested teach has between **one and three commands** allowing the patient to call for nurse and service assistance (one command), together with the independent starting or turning off of the general and reading light (two and three commands). In models with more commands, the lighting control is provided by the installation of an electronic command in a lighting control relay.

> The teach has a 2-meter-long electric cable and a 7 poles spiral hook to guarantee a **quick disconnection**. When an accidental tear occurs, this avoids also the breaking of the 6 poles DIN socket connector located directly on the bedhead unit.

> The DIN hook integrates itself with the lighting fitting **without the use of an external plate**, maintaining the elegance of the product and allowing the homogeneity of elements.

> Thanks to the **ergonomic design** and to the **simplified handle**, the cleaning and the maintaining of the teach results easy.

## ACCESSORI ACCESSORIES



### BARRA PORTACCESSORI A PARETE IN ACCIAIO INOX

- > Dimensioni: sezione 25x10 mm
- > Peso: 1,5 Kg/ml
- > Portata massima: 100 Kg /ml
- > Lunghezza massima disponibile: 3000 mm

#### INOX STEEL WALL MEDICAL RAILS

- > Dimensions: section 25x10 mm
- > Weight: 1,5 Kg/ml
- > Maximum capacity: 100 Kg/ml
- > Maximum length available: 3000 mm



### BARRA PORTACCESSORI VERTICALE A PARETE

- > Diametro del tubo: 38 mm
- > Altezza barra: 1000 mm
- > Peso totale: 2,3 Kg
- > Portata massima: 65 Kg a barra

#### WALL VERTICAL MEDICAL RAILS

- > Tube diameter: 38 mm
- > Height of the bar: 1000 mm
- > Total weight: 2,3 Kg
- > Maximum capacity: 65 Kg per bar



### LUCE VISITA CON BRACCIO FLESSIBILE

- > Lunghezza: 35mm
- > Potenza: 8W
- > Temperatura di colore: 4000K

#### EXAMINATION LIGHT WITH FLEXIBLE ARM

- > Length: 35mm
- > Power: 8W
- > Color temperature: 4000K



### MENSOLA

- > Corpo: acciaio inossidabile.
- > Altezza: 120mm
- > Portata massima: 40kg
- > Dimensione ripiano: 540mmx360mm

#### SHELF

- > Body: stainless steel.
- > Drawer height: 120mm
- > Maximum load: 40kg
- > Shelf size: 540mmx360mm



### MENSOLA MONITOR CON CASSETTO

- > Corpo: acciaio inossidabile
- > Altezza cassetto: 120mm
- > Portata massima: 40kg
- > Dimensione ripiano: 540mmx360mm
- > Dimensione cassetto: 420mmx310mm

#### MONITOR SHELF WITH DRAWER

- > Body: stainless steel.
- > Drawer height: 120mm
- > Maximum load: 40kg
- > Shelf size: 540mmx360mm
- > Drawer size: 420mmx310mm



### ASTA PORTAFLEBO

- > Corpo: acciaio inossidabile
- > Nr. di ganci: 4
- > Portata massima: 2kg a gancio

#### IV STAND

- > Body: stainless steel.
- > Nr. hooks: 4
- > Maximum load: 2kg per hook



### MODULO DI UNIONE PER TESTALETTO AUXILIA E SENSE

#### LINEAR JOINT FOR AUXILIA AND SENSE



### GANCIO SCORREVOLE IN ACCIAIO INOX

- > Portata massima: 15 Kg

#### INOX STEEL SLIDING HOOK

- > Maximum capacity: 15 Kg

## SISTEMA PENSILE SUSPENSION SYSTEM

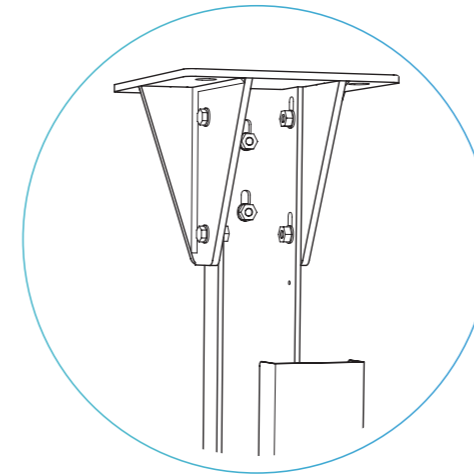

La trave testaletto AUXILIA con canale illuminazione, canale con gas medicinali, canale con prese elettriche UNEL, presa dati, prese equipotenziati e LED segnaletici di presenza di rete è disponibile nella versione sospesa. Il sistema pensile è costituito da due colonne verticali la cui lunghezza è stabilita in base alle necessità impiantistiche (lunghezza massima 2000mm ciascuna).

Le colonne hanno una sezione rettangolare di 100x50mm e sono realizzate in acciaio con relativa copertura, anch'essa in acciaio. All'interno di ogni singola colonna transitano le connessioni dell'impianto elettrico o dei gas medicinali. Le colonne verticali sono completamente ispezionabili su tutta la lunghezza mediante la rimozione di un coperchio di chiusura. Tutta questa robusta struttura viene supportata da una piastra di fissaggio a soffitto, realizzata in lamiera di acciaio.

Il sistema va ancorato ad un solaio (laterizio, cemento armato) in grado di sopportare il peso della trave testaletto e dei supporti, per tale motivo in aggiunta le colonne sono fornite complete di coperchio per nascondere l'eventuale taglio del controsoffitto. Il peso massimo della trave testaletto è di circa 20 kg/metro e i supporti pesano circa 15kg/metro ciascuna.

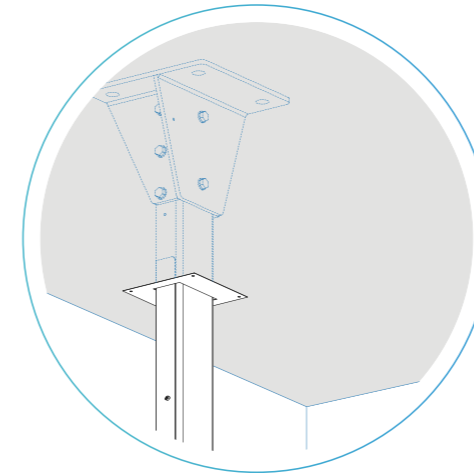

*Auxilia bedhead unit with channel for light distribution, channel for medical gases and UNEL sockets, data socket, equipotential sockets and LEDs for net connection. Can be also for suspended application, two columns are applied and its length is defined according with the system requirements (maximum length 2000mm each).*

*Columns are made with a steel C shaped profile and a steel covering. In every single column are located the connections of the electrical system or the connections of the medical gases. All this strong structure's sustained by a ceiling steel fixing plate.*

*The system must be anchored directly to ceilings (brick, reinforced concrete) able to support the weight of the bedhead unit and the suspensions, for this reason in addition the columns are supplied complete with a cover to hide the cutting of the false ceiling. The maximum weight of the bedhead unit per meter is about 20 kg and the columns weigh about 15kg per meter.*

SALE OPERATORIE E  
CAMERE BIANCHE

*OPERATING THEATRES  
AND CLEAN ROOMS*

- SISTEMA CERTIFICATO  
PER SALE OPERATORIE  
*CERTIFIED SYSTEM  
FOR OPERATING THEATRES*

- ILLUMINAZIONE PER SALE  
OPERATORIE  
*LIGHTING FOR OPERATING  
THEATRES*

- ILLUMINAZIONE SPECIFICA PER  
AMBIENTI A CONTAMINAZIONE  
CONTROLLATA  
*SPECIFIC LIGHTING FOR CONTROLLED  
CONTAMINATION ENVIRONMENTS*

90

91

96



## SISTEMA CERTIFICATO PER SALE OPERATORIE *CERTIFIED SYSTEM FOR OPERATING THEATRES*

ATENA LUX dispone di una gamma di corpi illuminanti specifici per sale operatorie e camere bianche.

In collaborazione con ATENA SPA, leader in Italia nella produzione di controsoffitti, l'azienda è in grado di fornire soluzioni **specifiche su progetto** che integrano **illuminazione e controsoffitto**.

I corpi illuminanti della famiglia TAURUS sono realizzati per consentire una perfetta integrazione al sistema controsoffitto creando un unicum tecnico-estetico. Questi controsoffitti sono realizzati al fine di impedire lo scambio di agenti aeriformi tra il plenum e l'ambiente, e garantire il mantenimento delle condizioni ambientali richieste all'interno delle sale operatorie e camere bianche.

Questo sistema è certificato per la tenuta dell'aria, la resistenza alla corrosione chimica, la purezza micro-particellare. I pannelli e i corpi illuminanti, realizzati in acciaio e alluminio, vengono inoltre trattati con speciale verniciatura antimicrobica per contribuire a mantenere i livelli di salubrità ambientale richiesti.

*ATENA LUX has a complete range of specific lighting fittings for operating theatres and clean rooms.*

*In collaboration with ATENA SPA, leader in Italy in the production of false metal ceilings, according to **specific project exigency** the company is able to provide a complete system that integrate lighting and **false ceiling**.*

*The lighting fittings of TAURUS family are developed to achieve a perfect technical and aesthetic **integration** between lighting and metal ceiling. These false ceilings are suitable for ceilings construction where ensuring stability between the plenum and the environment below is a need, assuring the maintenance of the environmental conditions required within the operating theatres and cleanrooms.*

*This system is certified for airtightness, resistance to chemical corrosion, micro-particle purity. The panels and lighting fittings, made of steel sheet and aluminum, are also treated with a special antimicrobial coating to help maintaining high hygiene standard in all sanitary rooms.*



## ILLUMINAZIONE PER SALE OPERATORIE *LIGHTING FOR OPERATING THEATRES*

Dotato di guarnizioni interne di tenuta, TAURUS garantisce la **protezione totale** contro la polvere e i getti d'acqua (IP65), disponibile nelle seguenti varianti:

- > Dimensioni: 300x1200 mm, 600x600 mm, 600x1200 mm
- > Diffusore:
  - MOT (Metacrilato opale ad alta trasmittanza e uniformità)
  - PMO (Microprismatico UGR<19)
  - VTR+PMO (Vetro + Microprismatico UGR<19)
- > Cablaggio: ON/OFF, DALI, EMERGENZA (1 o 3 ore di autonomia), RGB e HCL (a richiesta)

*Equipped with internal sealing gaskets, TAURUS guarantees **total protection** against dust and water jets (IP65), available with the following variants:*

- > *Dimensions: 300x1200 mm, 600x600 mm, 600x1200 mm*
- > *Diffuser:*
  - MOT (Opal methacrylate diffuser with high trasmittance and uniformity)*
  - PMO (Microprismatic UGR<19)*
  - VTR+PMO (Glass + Microprismatic UGR<19)*
- > *Wiring: ON/OFF, DALI, EMERGENCY (1 or 3 hours of autonomy), RGB and HCL (on request)*





# ILLUMINAZIONE PER SALE OPERATORIE

## LIGHTING FOR OPERATING THEATRES

### TAURUS/N

IP65 IP 65/20

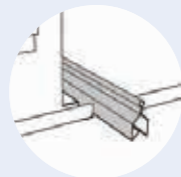

Profilo continentale  
*Continental profile*

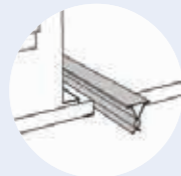

Profilo a triangolo  
*Triangle profile*

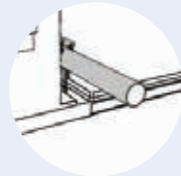

Profilo tubolare  
*Tube profile*  
Ø 22mm

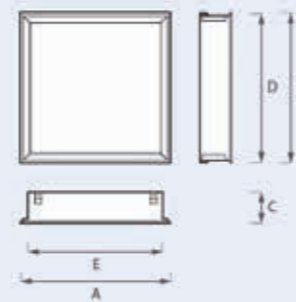

Dimensioni / Dimensions [mm]				
A	B	C	D	E
600	600	126	545	576
300	1200	126	245	1176
600	1200	126	545	1176

ADATTO PER : / SUITABLE FOR:

CARTONGESSO  
*PLASTERBOARD* IP 65/20

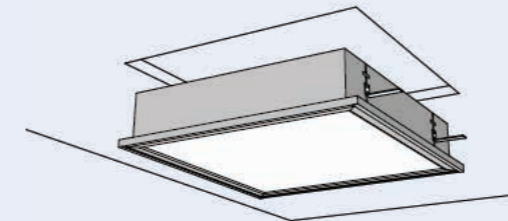

Controsoffitto in cartongesso.  
*Plasterboard false ceiling.*

585mm x 585mm  
285mm x 1185mm  
585mm x 1185mm

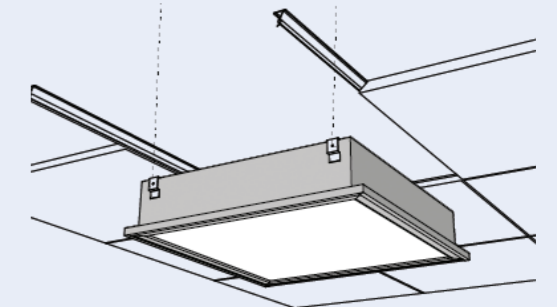

STRUTTURA NASCOSTA A TENUTA  
*CLIP-IN FALSE CEILING*  
*CONCEALED STRUCTURE*

Controsoffitto ispezionabile a pannelli modulari con struttura nascosta (profilo a triangolo o profilo con tubi "Elios", diametro 22mm e molle di imbracatura).

*Hook-down modular panels false ceiling with clip-in structure (triangle profile or "Elios" tubular profiles, 16 and 22mm diameter and slinging springs).*

### TAURUS/EVO

IP65

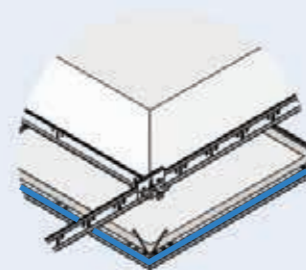

Sistema di tenuta Syncro Evo  
composto da molla di tenuta  
e guarnizione perimetrale  
*Syncro Evo sealing system*  
*consisting of sealing spring*  
*and perimeter gasket*

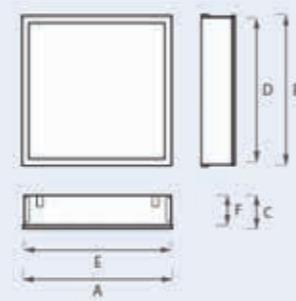

Dimensioni / Dimensions [mm]					
A	B	C	D	E	F
600	600	135	592	591	118
600	1200	135	1192	591	118

ADATTO PER : / SUITABLE FOR:

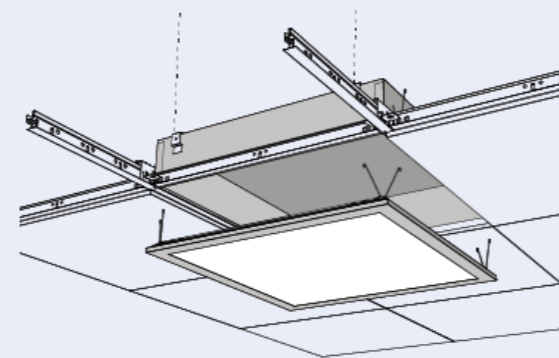

CONTROSOFFITTO ATENA SYNCRO EVO®  
*ATENA SYNCRO EVO® CEILING*

Controsoffitto Atena Syncro evo® a pannelli modulari per orditura a T base 24, specifico per ambienti ospedalieri. Pannello in aggancio su struttura a T24, le speciali molle del pannello esercitano una ferma pressione sulla guarnizione in neoprene, installata lungo i lati del pannello, garantendo la salubrità necessaria al locale.

*Atena Syncro evo® metal tiles false ceiling for T24 grid, properly conceived for hospitals. The special springs, hooked on T grid, make an high pressure on neoprene gasket installed along the tile, guaranteeing the environment cleaning.*

# ILLUMINAZIONE PER SALE OPERATORIE

## LIGHTING FOR OPERATING THEATRES

### TAURUS/CLIP

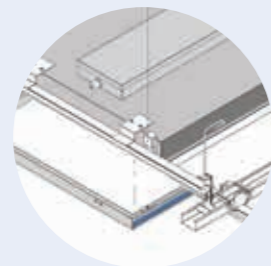

**Sistema Enigma a tenuta**  
composto guarnizione di tenuta  
*Enigma a tenuta sealing system*  
consisting of gasket



IP65

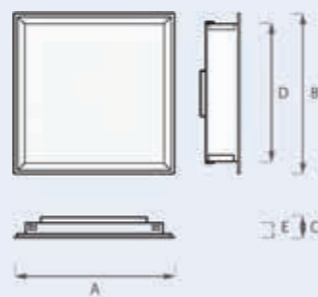

Dimensioni / Dimensions [mm]				
A	B	C	D	E
600	600	110,5	530	63,5
600	1200	110,5	1130	63,5

ADATTO PER : / SUITABLE FOR:

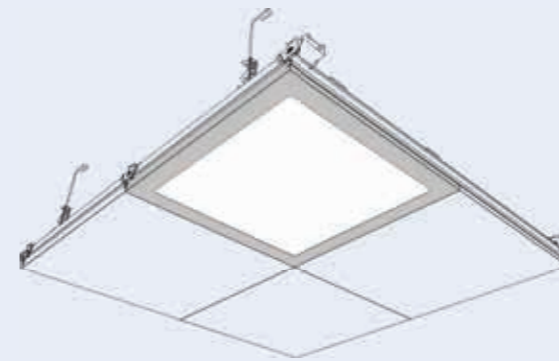

### CONTROSOFFITTO ATENA ENIGMA A TENUTA®

#### ATENA ENIGMA A TENUTA® CEILING

Atena Enigma a tenuta® è un controsoffitto clip-in modulare con doppia struttura nascosta. L'orditura si compone di profili a triangolo che intersecano i montanti mediante applicazione dell'aggancio Atena Winger®, mentre la pannellatura ermetica si installa per semplice aggancio ai profili secondari; in corrispondenza del perimetro, un profilo a "C" dotato di guarnizione neoprenica e molla spingi modulo, incornicia il controsoffitto sigillando il sistema.

*Atena Enigma a tenuta® is a modular clip-in false ceiling with double hidden structure. The warping is made up of triangular profiles that intersect the uprights by applying the Atena Winger® hook, while the hermetic paneling is installed by simple hooking to the secondary profiles; at the perimeter, a "C" profile equipped with a neoprene gasket and module pusher spring, frames the false ceiling, sealing the system.*

### TAURUS/TOP

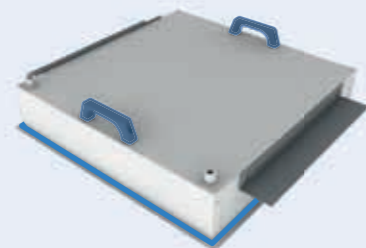

**Maniglie ergonomiche**  
per agevolare l'installazione dall'alto  
e guarnizione di tenuta  
*Ergonomic handles*  
to facilitate installation from above and  
sealing gasket



IP65/40

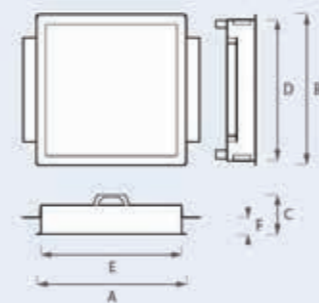

Dimensioni / Dimensions [mm]					
A	B	C	D	E	F
650	650	170	612	612	30 ÷ 90
350	1250	170	312	1212	30 ÷ 90
650	1250	170	612	1212	30 ÷ 90

ADATTO PER : / SUITABLE FOR:

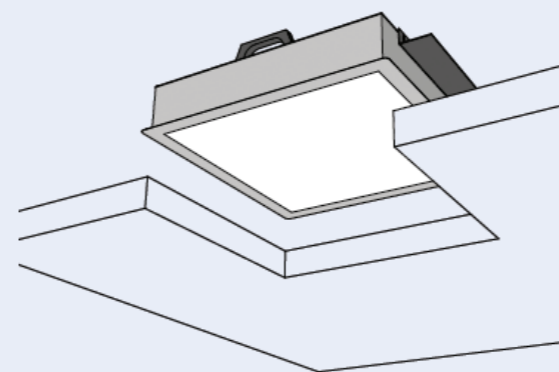

### CONTROSOFFITTO CALPESTABILE

#### WALKABLE CEILING



Controsoffitto calpestabile, ispezionabile dall'alto, in pannelli modulari del tipo sandwich (monopanel). L'installazione dei corpi illuminanti avviene in perfetta continuità con il controsoffitto tramite staffe regolabili in altezza.

*Walkable false ceiling, inspectable from above, in modular panels (sandwich or monopanel type). The product frame allows an installation in perfect continuity with the false ceiling, mounting kit with adjustable fixing brackets supplied.*



## ILLUMINAZIONE SPECIFICA PER AMBIENTI A CONTAMINAZIONE CONTROLLATA

### SPECIFIC LIGHTING FOR CONTROLLED CONTAMINATION ENVIRONMENTS

ATENA LUX, in collaborazione con aziende che si occupano di progettazione e installazione di camere bianche, studia soluzioni in grado di garantire il mantenimento delle condizioni ambientali richieste all'interno di questi specifici ambienti. I corpi illuminanti possono inoltre essere trattati con speciale verniciatura antimicrobica per contribuire a mantenere i livelli di salubrità ambientale richiesti.

*ATENA LUX, in collaboration with companies that deal with the design and installation of clean rooms, studies solutions capable of guaranteeing the maintenance of the environmental conditions required within these specific environments. The lighting fixtures can also be treated with a special antimicrobial paint to help maintain the required levels of environmental health.*



LUCE AMBRA MQ E AMBRA HQ | **AMBER MQ AND AMBER HQ LIGHT**



LUCE BIANCA + LUCE RED (630-675 NM) | **WHITE LIGHT + RED LIGHT (630-675 NM)**

#### LUCE AMBRA MQ E AMBRA HQ

Versioni con sorgenti LED selezionate che presentano lunghezze d'onda tra i 550 e 690 nm, dalla caratteristica luce ambrata-arancione, che tutelano alcuni materiali sensibili ai raggi ultravioletti e infrarossi negli ambienti di lavorazione o conservazione (laboratori, industrie).

#### AMBER MQ AND AMBER HQ LIGHT

*Versions with selected LED sources that have wavelengths between 550 and 690 nm, with a characteristic amber-orange light, which protect some materials sensitive to ultraviolet and infrared rays in processing or storage environments (laboratories, industries).*

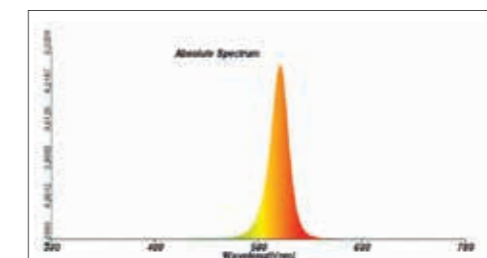
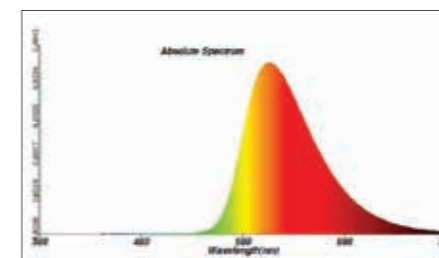

#### LUCE BIANCA + LUCE RED (630-675 NM)

E' possibile implementare la funzione illuminante della lampada Taurus con sorgenti LED a luce infrarossa che presentano lunghezze d'onda tra i 630 e 675 nm. Questo spettro viene generalmente utilizzato per studiare il comportamento delle cavie nei laboratori.





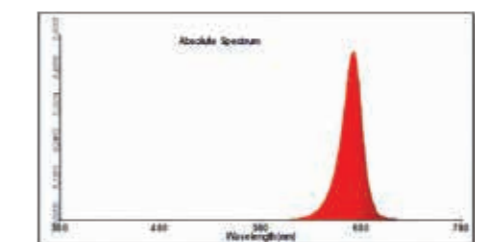
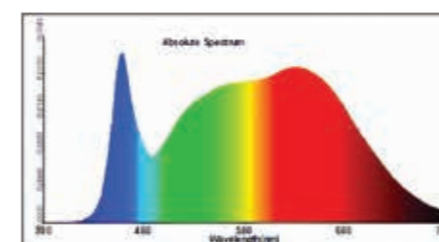















#### WHITE LIGHT + RED LIGHT (630-675 NM)

*The illuminating function of the Taurus lamp can be implemented with infrared light LED sources that have wavelengths between 630 and 675 nm. This spectrum is generally used to study the behavior of guinea pigs in laboratories.*



# PITTOGRAMMI

## PICTOGRAMS

	Il prodotto rispetta le direttive di compatibilità elettromagnetica stabilite dalla Comunità Europea 2014/30/UE e 2014/35/UE, rispondendo quindi a tutti i requisiti di sicurezza e potendo circolare liberamente all'interno del territorio europeo.	<i>The product meets the directives on electromagnetic compatibility 2014/30/UE and 2014/35/UE, defined by the European Community and meets each safety requirement and can freely circulate in the whole European territory.</i>
	Bianco dinamico.	<i>Tunable White.</i>
	Controllo dell'abbagliamento (Unified Glare Rating).	<i>Glare control (Unified Glare Rating).</i>
	Indice di resa cromatica che indica quanto naturali appaiono i colori una volta illuminati dalle sorgenti luminose.	<i>Color Rendering Index showing how natural colors seem once illuminated by the light sources.</i>
	Apparecchio per controsoffitto calpestabile.	<i>Walkable false ceiling device.</i>
	Grado di protezione dell'apparecchio.	<i>Protection degree.</i>
	Al raggiungimento delle 50000 ore di funzionamento, il 90% (B10) delle sorgenti LED è in grado di garantire un flusso luminoso residuo di almeno il 90% del flusso luminoso iniziale (L90).	<i>After 50000 hours of operation, 90% (B10) of the LED sources is able to guarantee a residual luminous flux of at least 90% of the initial luminous flux (L90).</i>
	Al raggiungimento delle 50000 ore di funzionamento, il 90% (B10) delle sorgenti LED è in grado di garantire un flusso luminoso residuo di almeno l' 80% del flusso luminoso iniziale (L80).	<i>After 50000 hours of operation, 90% (B10) of the LED sources is able to guarantee a residual luminous flux of at least 80% of the initial luminous flux (L80).</i>
	I LED utilizzati appartengono a diversi gruppi di rischio, come stabilito dalla normativa EN 62471. All'interno di tale classificazione, il gruppo di rischio esente ed il gruppo di rischio basso non costituiscono un pericolo per la salute.	<i>LEDs come from different risk groups, as defined by the EN 62471 regulation. In this classification, the exempt risk group and the low risk group do not represent a danger for human health.</i>
	I LED installati all'interno del prodotto sono esenti dall'emissione di raggi UV e IR.	<i>LEDs inside the device are free from UV and IR rays emission.</i>
	(Restriction of Hazardous Substances) Per la realizzazione di questo prodotto non sono stati utilizzati piombo, cadmio, cromo esavalente, bifenili polibromurati, eteri di difenile polibromurati. Il prodotto risulta quindi conforme alla direttiva comunitaria 2011/65/C.	<i>(Restriction of Hazardous Substances) To realize this device we haven't used: lead, cadmium, hexavalent chromium, polybrominated biphenyls and polybrominated ethers. This means that the product responds to the European Directive 2011/65/C.</i>
	Classe di isolamento I	<i>Insulation Class I</i>
	Apparecchio da installare a sospensione.	<i>Device for suspended installation.</i>
	Apparecchio da installare a parete.	<i>Device for wall installation.</i>
	L'apparecchio emette solo luce indiretta.	<i>The device emits indirect light only.</i>
	L'apparecchio emette solo luce diretta.	<i>The device emits direct light only.</i>
	L'apparecchio emette contemporaneamente luce diretta e indiretta.	<i>The device emits simultaneously direct and indirect light.</i>
	L'apparecchio emette luce notturna.	<i>The device emits night light.</i>
	Degenza	<i>Patient room</i>
	Terapia Intensiva	<i>Intensive care</i>
	Laboratorio	<i>Laboratory</i>



Al fine di un continuo miglioramento della gamma, Atena Lux si riserva il diritto di apportare modifiche in qualsiasi momento e senza preavviso, alle specifiche dei prodotti descritti. Le immagini e le riproduzioni dei prodotti sono da ritenersi esemplificative.

*In order to obtain better performances, Atena Lux reserves the right to modify products specifications, at any time and with no prior warning. Images and reproductions of all products shall be considered illustratives.*

